



SUNON

SPECIFICATION FOR APPROVAL

CUSTOMER :
 DESCRIPTION : AXIAL AC FAN
 MODEL : A2259-MBL
 TC
 APPROVED NO :
 (AUTHORIZED)
 APPROVED BY :



DAWN	<i>Yuchen 5/4</i>	CHKD.	<i>Kody</i>	APPD.	<i>[Signature]</i>	SPEC. NO.	A250006
						ISSUE DATE	10.02.2000
						EDITION	1
						REVISE DATE	05.04.2001
						E.SPEC	EA25006

建準電機工業股份有限公司
 SUNONWEALTH ELECTRIC MACHINE INDUSTRY CO., LTD.
 12FL., 120 CHUNG CHENG 1ST RD., TEL:886-7-7163069(41 LINES)
 KAOHSIUNG, TAIWAN, R. O. C. ~ FAX:886-7-7163086~89

MODEL NUMBERING SYSTEM

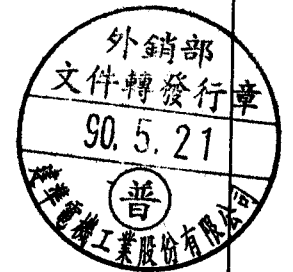
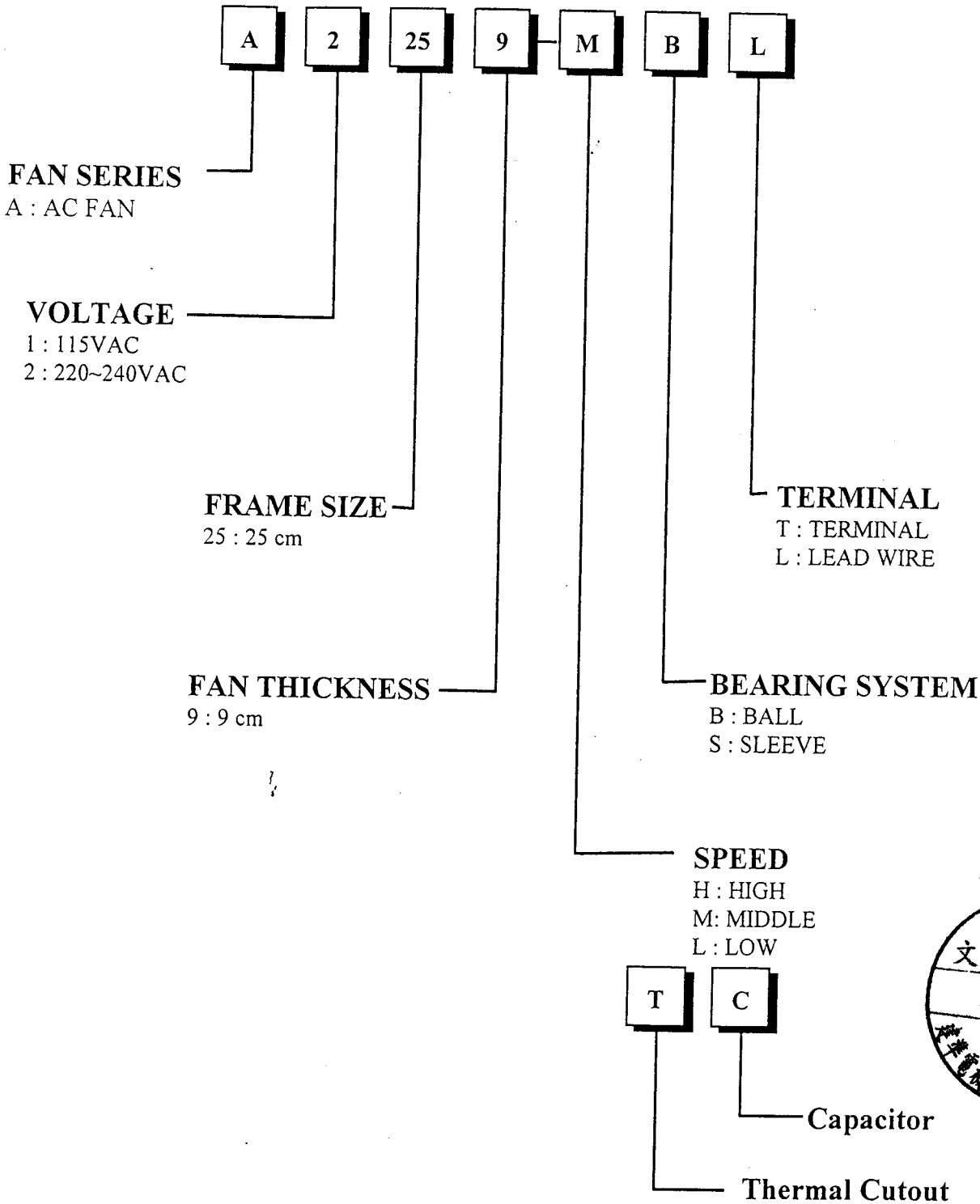

建準電機工業股份有限公司
SUNONWEALTH ELECTRIC
MACHINE INDUSTRY CO., LTD

SPEC. NO.	A250006
ISSUE DATE	10. 02. 2000
PAGE	1 OF 7

REVISE DATE	90. 05. 16
EDITION	90. 15. 16



AXIAL AC FAN

MODEL : A2259-MBL
TC

CHARACTERISTICS

- 1. Motor Design : Reliable Alveolate Motor Contraction.
- 2. Insulation Resistance : 500Megohms minimum at 500 VAC.
- 3. Dielectric Strength : 1500 VAC for one minute.
- 4. Motor Protection : Thermal protected.
- 5. Noise Level : Measured in a semi-anechoic chamber with background noise level below 15 dB(A). The fan is running in free air with microphone at a distance of one meter from the fan intake.
- 6. Air Performance : Measured by a double chamber. The ~~外銷部~~ ~~文件轉發行章~~ are recorded when the fan speed is ~~90~~ ~~5.21~~ ~~Hz~~ ~~Blitzed~~ at rated voltage.
- 7. Tolerances : $\pm 15\%$ on rated power and current

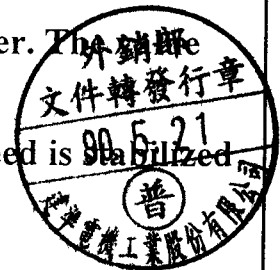

建準電機工業股份有限公司
SUNONWEALTH ELECTRIC
MACHINE INDUSTRY CO., LTD

SPEC. NO.	A250006	REVISE DATE	90.05.04.2001
ISSUE DATE	10.02.2000	EDITION	1
PAGE	2 OF 7		

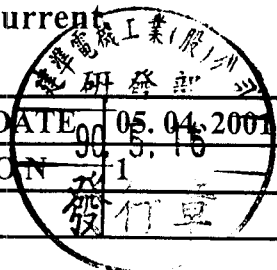

SPECIFICATIONS

**MODEL : A2259-MBL
TC**

- 1-1. Rated Voltage : 230 VAC 50/60 Hz
- 1-2. Operating Voltage Range : 150-245 VAC
- 1-3. Starting Voltage : 150 VAC
- 1-4. Rated Speed : 1400/1600 RPM \pm 10%
- 1-5. Air Delivery : 600/665 CFM
- 1-6. Static Pressure : 0.27/0.36 Inch-H₂O
- 1-7. Rated Current : 0.15/0.13 AMP
- 1-8. Input Power : 30/30 WATTS
- 1-9. Noise Level : 50/52 dB(A)
- 1-10. Direction of Rotation : Counter-clockwise viewed front fan blade
- 1-11. Motor Protection : Thermal Protected.
- 1-12. Operating Temperature : -10 to +80 Deg.C
- 1-13. Storage Temperature : -30 to +80 Deg.C
- 1-14. Bearing System : Precise ball bearing system
- 1-15. Weight : 2000g
- 1-16. Vibration : Vibration of acceleration 1.5G and Frequency 5~50~5Hz is applied in the 3 directions(X,Y,Z) for 30 minutes, Direction at the cycle of 1 minute.
- 1-18. Life Expectancy : 50,000 Hrs at 25°C.



建準電機工業股份有限公司
SUNONWEALTH ELECTRIC
MACHINE INDUSTRY CO., LTD

SPEC. NO.	A250006	REVISE DATE	研發部: 2001
ISSUE DATE	10. 02. 2000	EDITION	5. 16
PAGE	3 OF 7		



MODEL : A2259-MBL
TC

PERFORMANCE CURVES

STATIC
PRESSURE

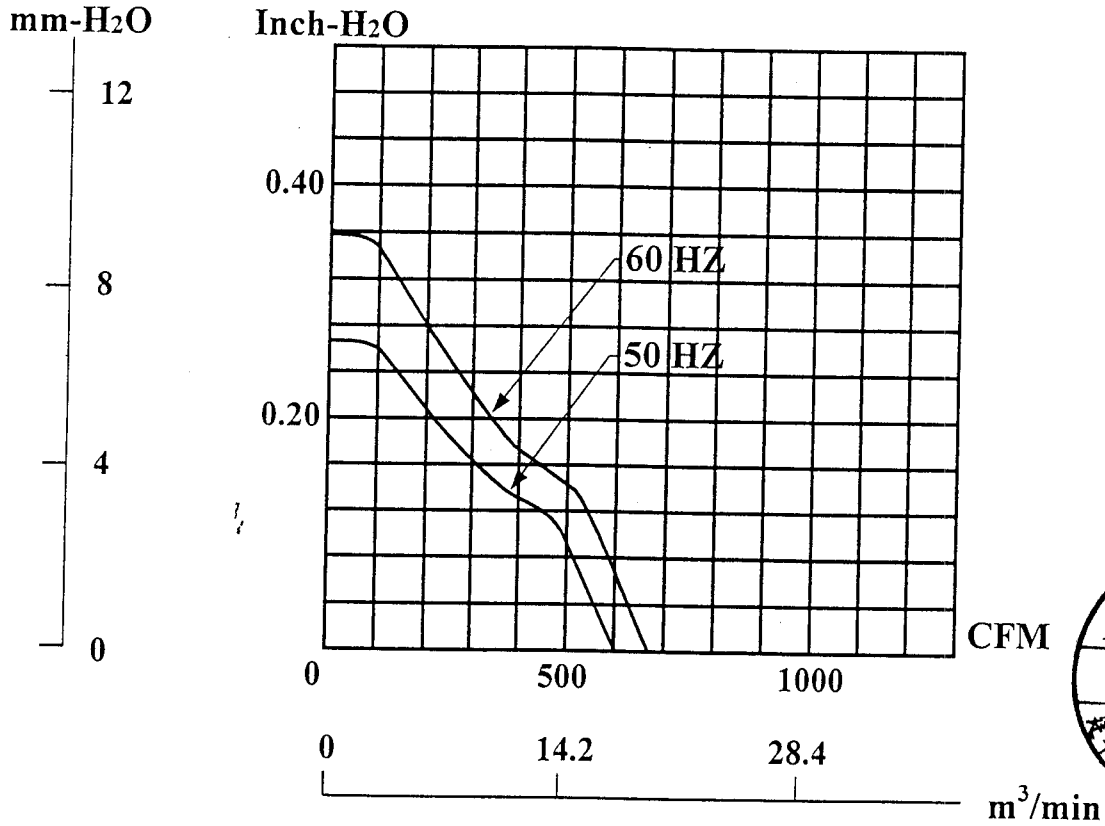

建準電機工業股份有限公司
SUNONWEALTH ELECTRIC
MACHINE INDUSTRY CO., LTD

SPEC. NO.	A250006	REVISE DATE	05.04.2001
ISSUE DATE	10.02.2000	EDITION	15.16
PAGE	4 OF 7		



MATERIAL

2. Material

- 2-1. Frame : DIE-CAST ALUMINUM
- 2-2. Impeller : Thermoplastic PBT of UL 94V-0
- 2-3. Lead Wire : UL1015,20AWG,BLACK

DIMENSIONS

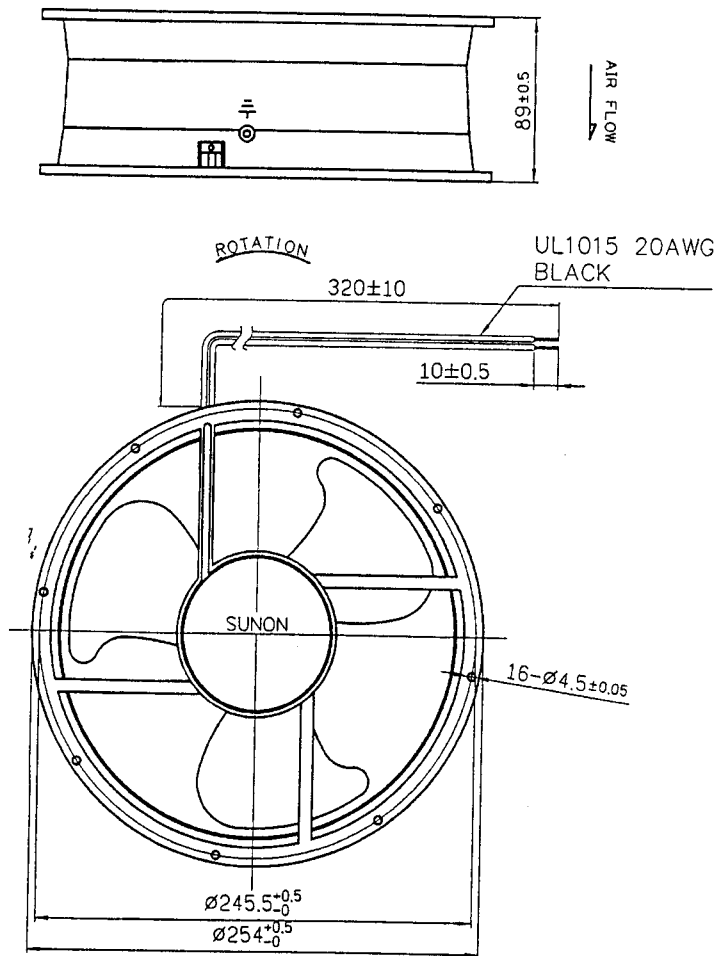

Air Flow Direction: Label side.

UNITS: mm

建準電機工業股份有限公司 SUNONWEALTH ELECTRIC MACHINE INDUSTRY CO., LTD	SPEC. NO.	A250006	REVISE DATE	05.04.2001
	ISSUE DATE	10.02.2000	EDITION	90.5.10
	PAGE	5 OF 7		

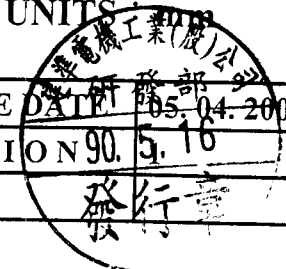

Alveolate Motor

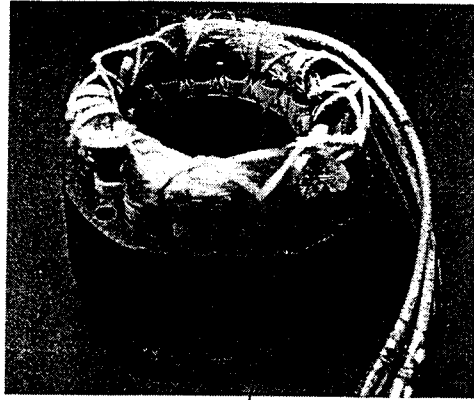

Thermal Cutout

With Capacitor

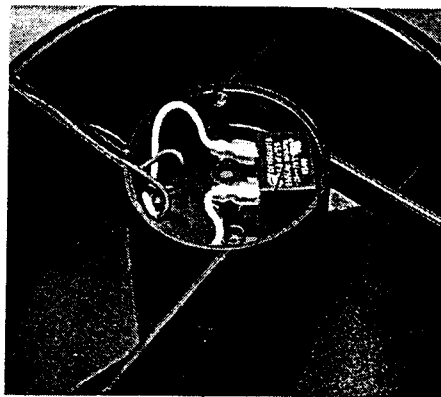

Capacitor



建準電機工業股份有限公司
SUNONWEALTH ELECTRIC
MACHINE INDUSTRY CO., LTD

SPEC. NO.	A250006
ISSUE DATE	10. 02. 2000
PAGE	6 OF 7

REVISED	05.06.001
EDITION	1.16

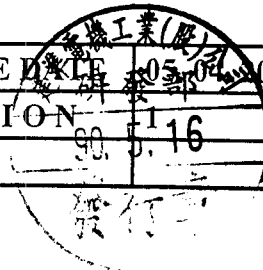

Notes

1. SUNON will not guarantee the products if the application of our products is exceeded the limitation which is specified on this specification.
2. In case of change of the specification specified on this document, a written notice is requested in advance.
3. Please do not touch the impeller with pressure and never bring the fan with lead wire. The bearings and lead wire may be damaged.
4. No guarantee on the products against the safety problem or failure caused by powder dust, drop of water or insect.
5. If there is any data or related documentation different from this data sheet, this data sheet is the principal reference.
6. For the purpose of MIS, please indicate SPEC No. on every order.
7. In case of the fan has no polarity protection function, wires with same color (electrode) must be connected together during the assembly. (i.e. red + red, black + black) or the fan will be damaged immediately.
8. Please do not use the fan in the environment of corrosive gas or liquid or any detrimental gas.
9. Please do not store the fan in the environment of high / low temperature, high humidity or any detrimental gas. Please store the fan within 6 months, every 6 months, there shall be a linkage of electric current to the fan, even though the fan is stored in room temperature.
10. While the fan is in operation, please do not lock the fan intentionally for a long period of time, since the continuous stoppage will result in over-heat and damage of the fan.
11. During the installation of the fan, please pay substantial attention to possible noise cause by resonance vibration and vibration.
12. During the testing of the fan, please be sure to use finger guard to insure safety.
13. Unless otherwise specified, if there is any doubt in the judgement, the temperature and relative humidity range of environment will be take in according to the standard test condition as 25°C and 65%.

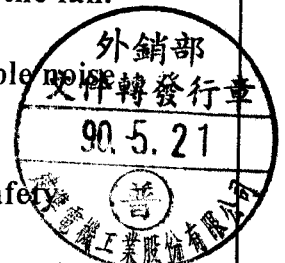

建準電機工業股份有限公司
SUNONWEALTH ELECTRIC
MACHINE INDUSTRY CO., LTD

SPEC. NO.	A250006	REVISED	05.04.2001
ISSUE DATE	10. 02. 2000	EDITION	研發部
PAGE	7 OF 7		90.5.16

