



# NEC's HIGH CTR, 4 OR 16 PIN SOP OPTOCOUPLER

## PS2811-1 PS2811-4

### FEATURES

- **HIGH CURRENT TRANSFER RATIO:**  
CTR = 200% TYP @  $I_F = 1 \text{ mA}$
- **HIGH ISOLATION VOLTAGE:**  
BV: 2.5 k  $V_{r.m.s.}$
- **SMALL THIN PACKAGE:**  
4, 16-pin SOP, Pin pitch 1.27 mm
- **AVAILABLE IN TAPE AND REEL**

### DESCRIPTION

NEC's PS2811-1 and PS2811-4 are optically coupled isolators containing a GaAs light emitting diode and an NPN silicon phototransistor in a plastic SOP (Small Out-Line Package) for high density applications.

### APPLICATIONS

- PROGRAMMABLE LOGIC CONTROLLERS
- SMALL POWER SUPPLY
- HYBRID IC
- MODEM/FAX

### ELECTRICAL CHARACTERISTICS ( $T_A = 25^\circ\text{C}$ )

PART NUMBER			PS2811-1, PS2811-4			
SYMBOLS	PARAMETERS	UNITS	MIN	TYP	MAX	
Diode	$V_F$	Forward Voltage, $I_F = 5 \text{ mA}$	V	1.15	1.4	
	$I_R$	Reverse Current, $V_R = 5 \text{ V}$	$\mu\text{A}$		5	
	$C_t$	Terminal Capacitance, $V = 0, f = 1.0 \text{ MHz}$	pF		30	
Transistor	$I_{CEO}$	Collector to Emitter Current, $I_F = 0, V_{CE} = 40 \text{ V}$	nA		100	
Coupled	CTR	Current Transfer Ratio ( $I_C/I_F$ ) <sup>1</sup> , $I_F = 1 \text{ mA}, V_{CE} = 5 \text{ V}$	%	100	200	400
	$V_{CE(sat)}$	Collector Saturation Voltage, $I_F = 1 \text{ mA}, I_C = 0.2 \text{ mA}$	V			0.3
	$R_{I-O}$	Isolation Resistance, $V_{in-out} = 1.0 \text{ kVDC}$	$\Omega$	$10^{11}$		
	$C_{I-O}$	Isolation Capacitance, $V = 0, f = 1.0 \text{ MHz}$	pF		0.4	
	$t_r$	Rise Time <sup>2</sup> , $V_{CC} = 5 \text{ V}, I_C = 2 \text{ mA}, R_L = 100 \Omega$	$\mu\text{s}$		4	
$t_f$	Fall Time <sup>2</sup> , $V_{CC} = 5 \text{ V}, I_C = 2 \text{ mA}, R_L = 100 \Omega$	$\mu\text{s}$		5		

Notes:

1. CTR Rank

**PS2811-1**

N: 100 to 400 (%)

K: 200 to 400 (%)

L: 150 to 300 (%)

M: 100 to 200 (%)

**PS2811-4**

N: 100 to 400 (%)

2. Test Circuit for Switching Time

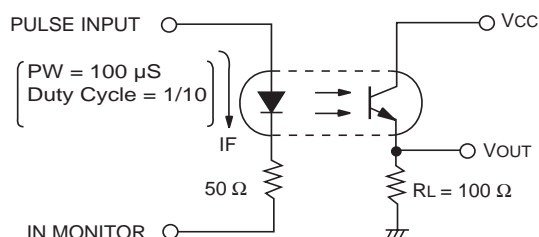

PS2811-1



PS2811-4

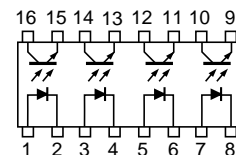

# PS2811-1, PS2811-4

## ABSOLUTE MAXIMUM RATINGS<sup>1</sup> (T<sub>A</sub> = 25°C)

SYMBOLS	PARAMETERS	UNITS	RATINGS	
			PS2811-1	PS2811-4
Diode				
V <sub>R</sub>	Reverse Voltage	V	6	6
I <sub>F</sub>	Forward Current (DC)	mA	50	50
ΔP <sub>D</sub> /°C	Power Dissipation Derating	mW/°C	0.6	0.7
P <sub>D</sub>	Power Dissipation	mW/Ch	60	70
I <sub>F</sub> (Peak)	Peak Forward Current PW = 100 μs, Duty Cycle 1%	A	0.5	0.5
Transistor				
V <sub>CEO</sub>	Collector to Emitter Voltage	V	40	40
V <sub>ECO</sub>	Emitter to Collector Voltage	V	5	5
I <sub>C</sub>	Collector Current	mA/Ch	40	40
ΔP <sub>C</sub> /°C	Power Dissipation Derating	mW/°C	1.2	1.2
P <sub>C</sub>	Power Dissipation	mW/Ch	120	120
Coupled				
BV	Isolation Voltage <sup>2</sup>	V <sub>r.m.s.</sub>	2500	
T <sub>STG</sub>	Storage Temperature	°C	-55 to +150	
T <sub>A</sub>	Operating Ambient Temp.	°C	-55 to +100	

### Notes:

- Operation in excess of any one of these parameters may result in permanent damage.
- AC voltage for 1 minute at T<sub>A</sub> = 25 °C, RH = 60 % between input and output.

## ORDERING INFORMATION

PART NUMBER	PACKAGE	PACKING STYLE
PS2811-1	4-pin SOP	50 pcs (Tape 50 pcs cut)
PS2811-1-F3		Embossed Tape 3500 pcs/reel
PS2811-1-F4		
PS2811-4	16-pin SOP	Magazine Case 45 pcs
PS2811-4-F3		Embossed Tape 2500 pcs/reel
PS2811-4-F4		

## OUTLINE DIMENSIONS (Units in mm)

PS2811-1

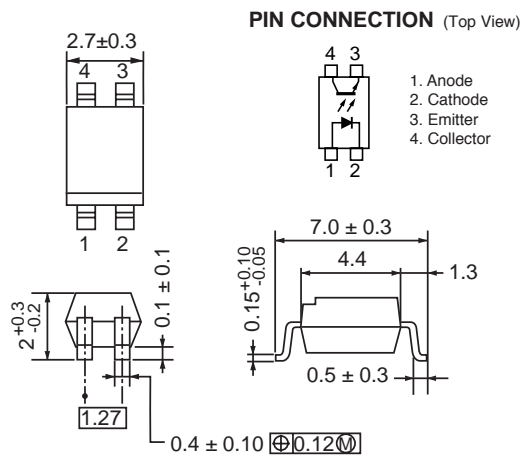

PS2811-4

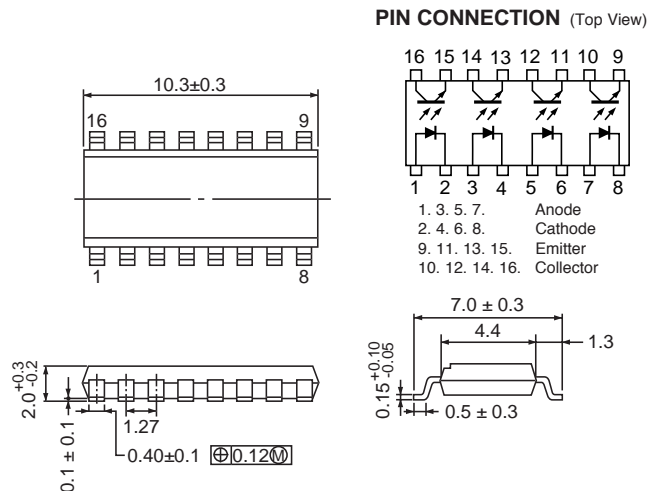

## MARKINGS

PS2811-1

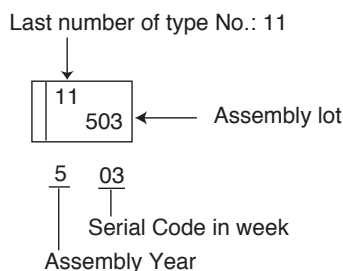

PS2811-4

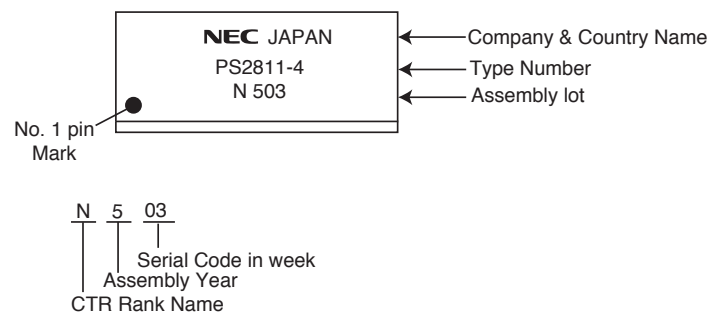

TYPICAL PERFORMANCE CURVES (TA = 25 °C)

DIODE POWER DISSIPATION vs. AMBIENT TEMPERATURE

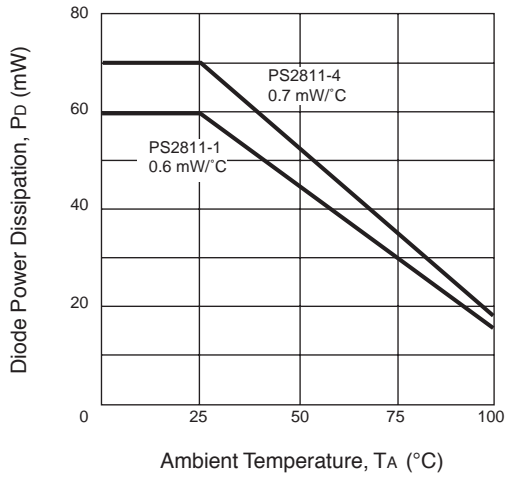

TRANSISTOR POWER DISSIPATION vs. AMBIENT TEMPERATURE

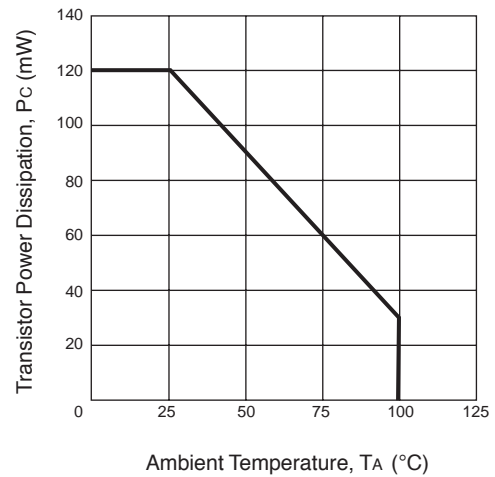

FORWARD CURRENT vs. FORWARD VOLTAGE

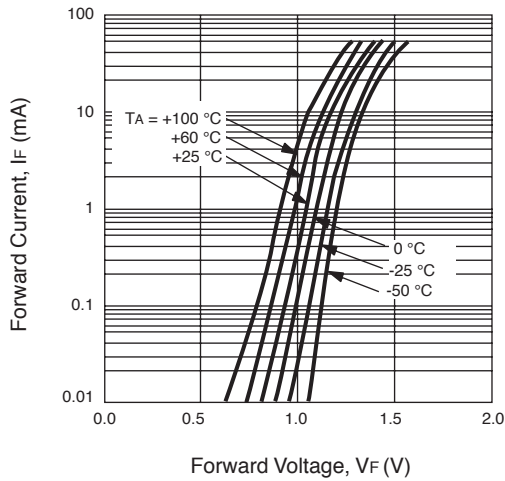

COLLECTOR CURRENT vs. COLLECTOR TO EMITTER VOLTAGE

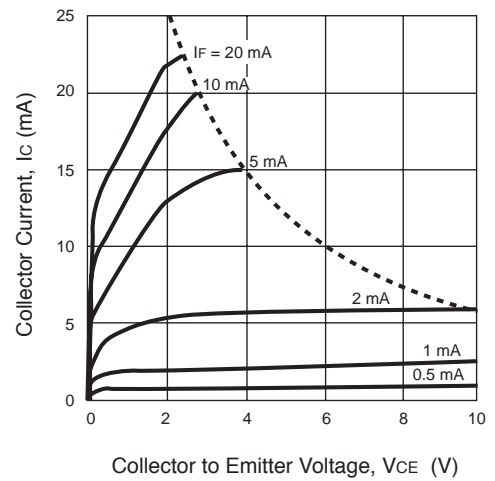

COLLECTOR TO EMITTER DARK CURRENT vs. AMBIENT TEMPERATURE

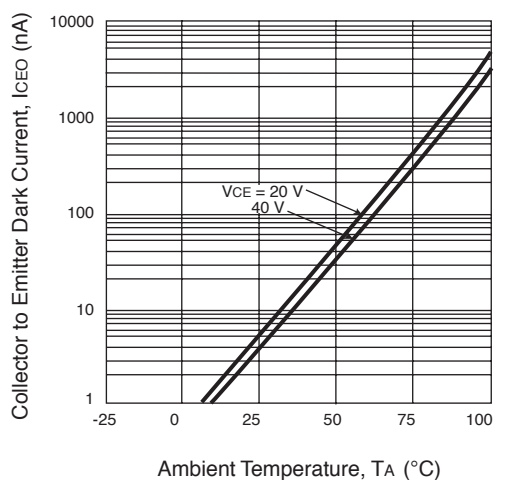

COLLECTOR CURRENT vs. COLLECTOR SATURATION VOLTAGE

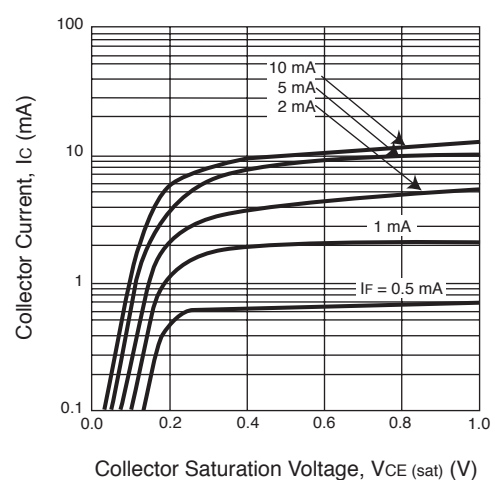

TYPICAL PERFORMANCE CURVES (TA = 25 °C)

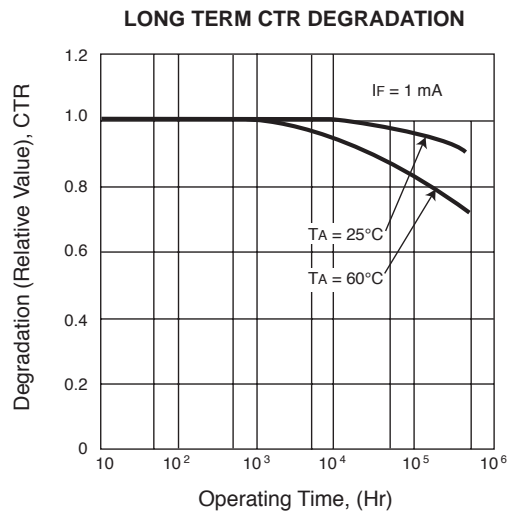
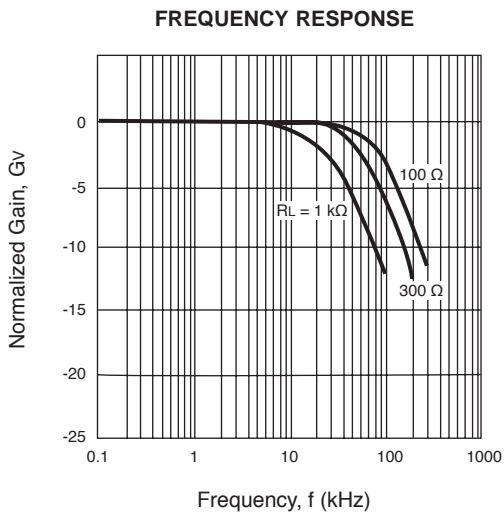
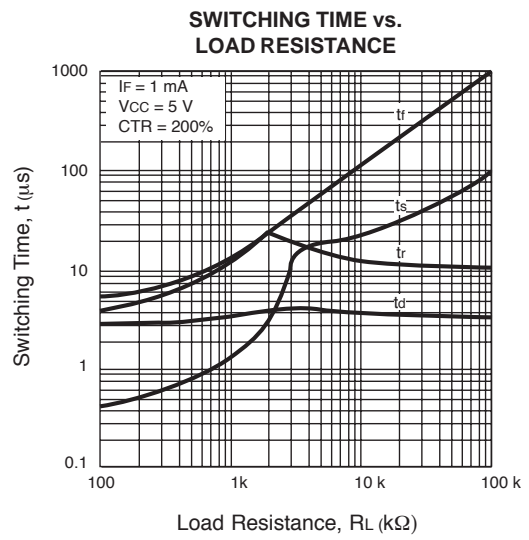
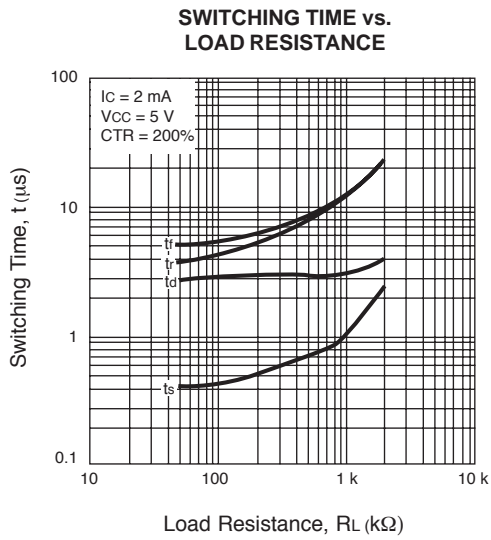
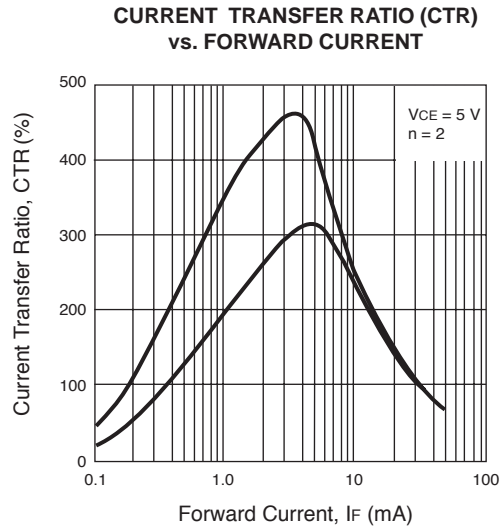
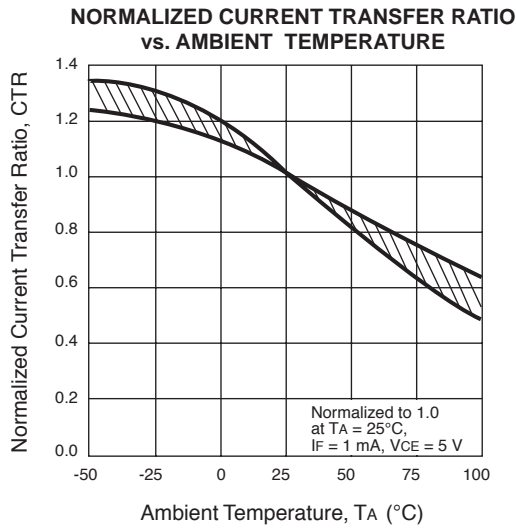

**PS2811-1 TAPING SPECIFICATIONS** (Units in mm)

**Outline and Dimensions (Tape)**

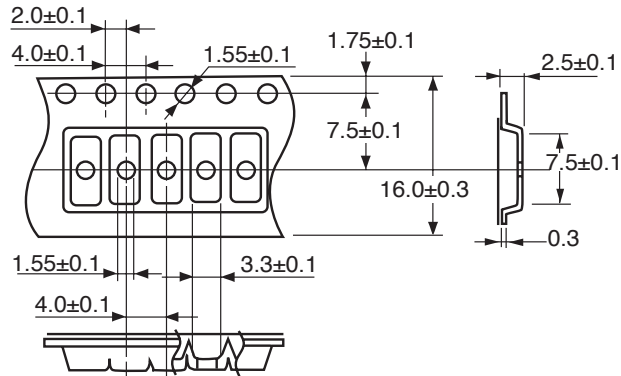

**Tape Direction**

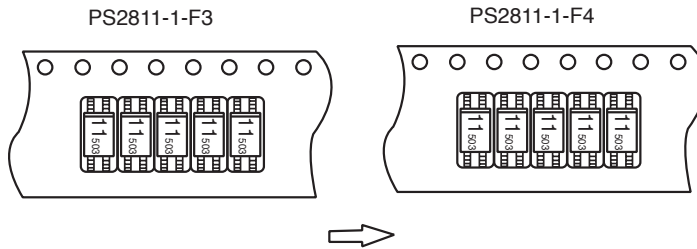

**Outline and Dimensions (Reel)**

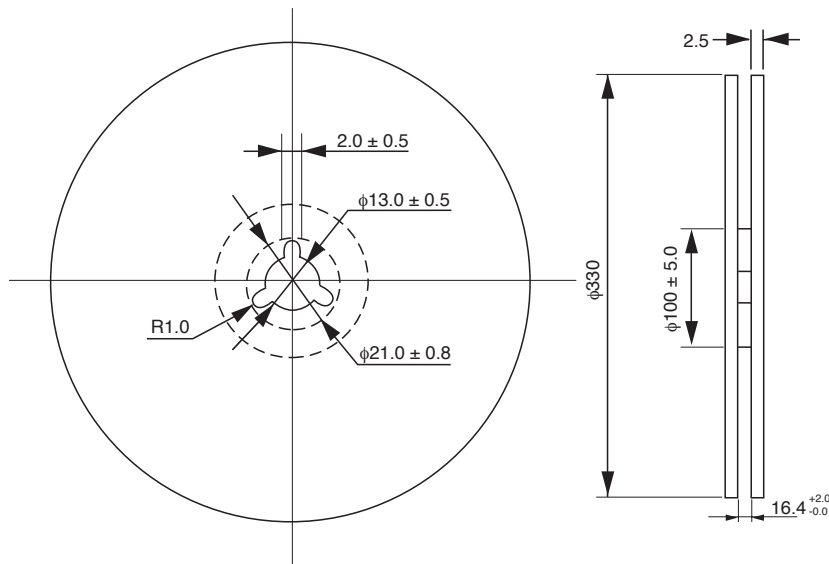

Packing: 3500 pcs/reel

# PS2811-1, PS2811-4

## PS2811-4 TAPING SPECIFICATIONS (Units in mm)

### Outline and Dimensions (Tape)

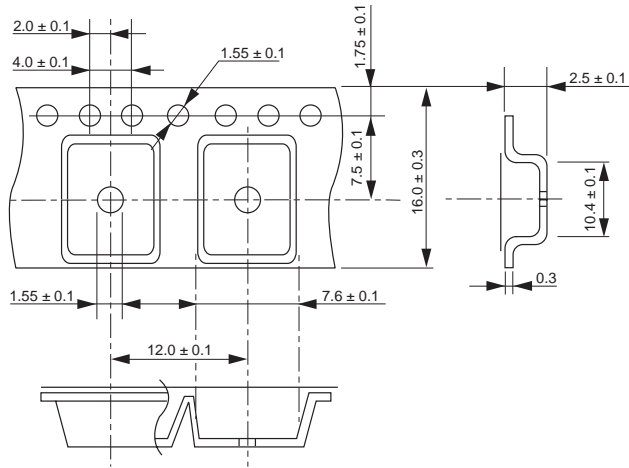

### Tape Direction

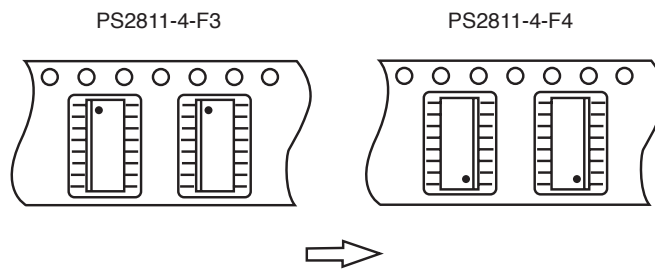

### Outline and Dimensions (Reel)

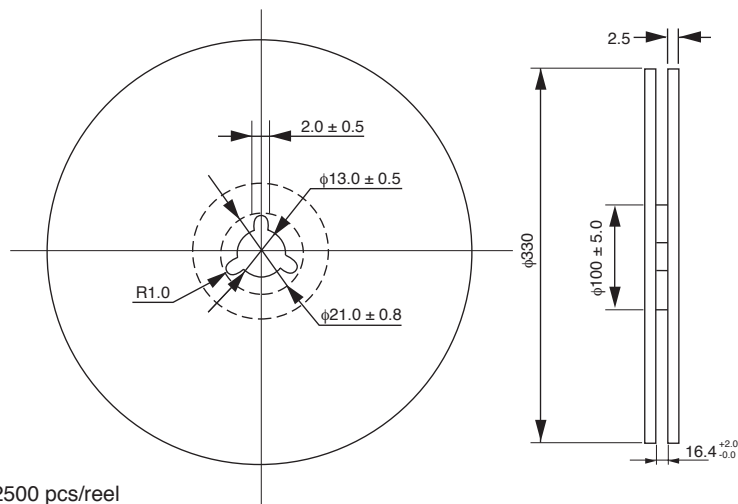

Packing: 2500 pcs/reel

## RECOMMENDED SOLDERING CONDITIONS

### (1) Infrared reflow soldering

- Peak reflow temperature 235 °C or below (package surface temperature)
- Time of temperature higher than 210 °C 30 seconds or less
- Number of reflows Three
- Flux Rosin flux containing small amount of chlorine  
(The flux with a maximum chlorine content of 0.2 Wt % is recommended.)

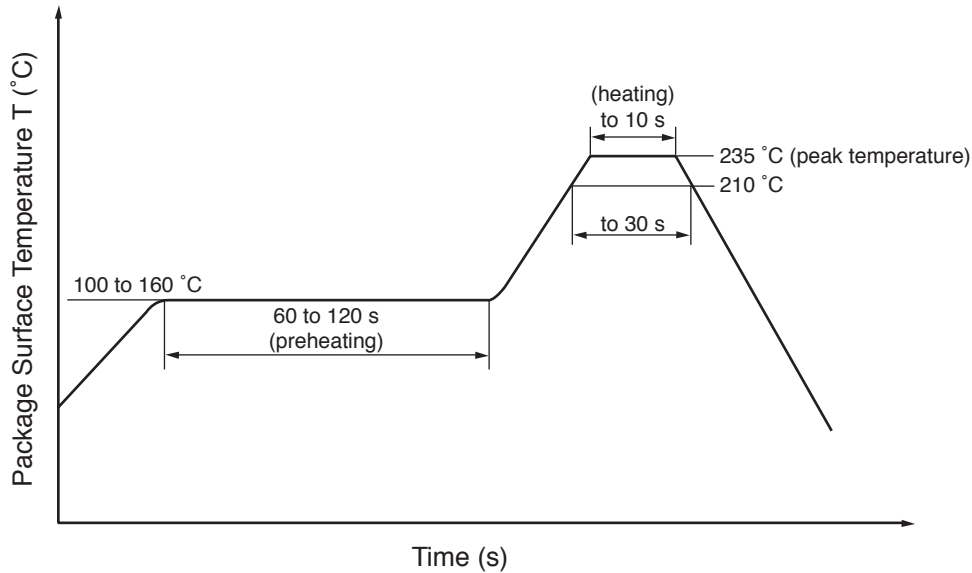

### (2) Dip soldering

- Temperature 260 °C or below (molten solder temperature)
- Time 10 seconds or less
- Number of times One
- Flux Rosin flux containing small amount of chlorine  
(The flux with a maximum chlorine content of 0.2 Wt % is recommended.)

### (3) Cautions

- Fluxes  
Avoid removing the residual flux with freon-based cleaning solvent.

#### Life Support Applications

These NEC products are not intended for use in life support devices, appliances, or systems where the malfunction of these products can reasonably be expected to result in personal injury. The customers of CEL using or selling these products for use in such applications do so at their own risk and agree to fully indemnify CEL for all damages resulting from such improper use or sale.

**CEL** California Eastern Laboratories, Your source for NEC RF, Microwave, Optoelectronic, and Fiber Optic Semiconductor Devices.

4590 Patrick Henry Drive • Santa Clara, CA 95054-1817 • (408) 988-3500 • FAX (408) 988-0279 • [www.cel.com](http://www.cel.com)

DATA SUBJECT TO CHANGE WITHOUT NOTICE

10/14/2003