



2SA2039/2SC5706

Bipolar Transistor (-50V, (-)5A, Low VCE(sat), (PNP)NPN Single TP/TP-FA

ON Semiconductor®

<http://onsemi.com>

Applications

- DC / DC converter, relay drivers, lamp drivers, motor drivers, flash

Features

- Adoption of FBET and MBIT processes
- Large current capacitance
- Low collector-to-emitter saturation voltage
- High-speed switching
- High allowable power dissipation

Specifications () : 2SA2039

Absolute Maximum Ratings at Ta=25°C

Parameter	Symbol	Conditions	Ratings	Unit
Collector-to-Base Voltage	V _{CB0}		(-50)100	V
Collector-to-Emitter Voltage	V _{CES}		(-50)100	V
Collector-to-Emitter Voltage	V _{CEO}		(-)50	V
Emitter-to-Base Voltage	V _{EB0}		(-)6	V
Collector Current	I _C		(-)5	A
Collector Current (Pulse)	I _{CP}		(-)7.5	A

Continued on next page.

Package Dimensions unit : mm (typ) 7518-003

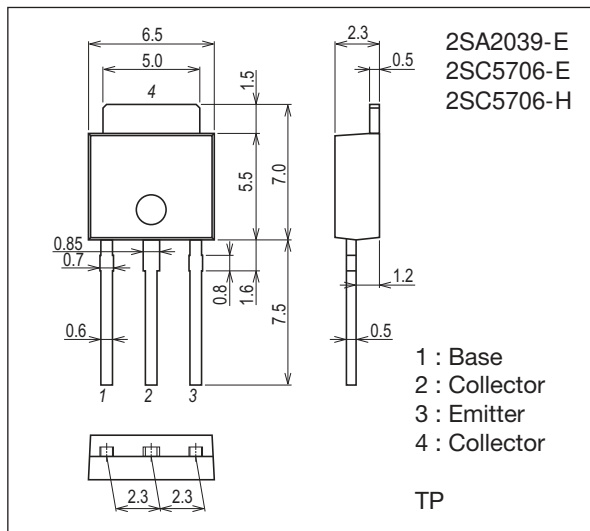

Package Dimensions unit : mm (typ) 7003-003

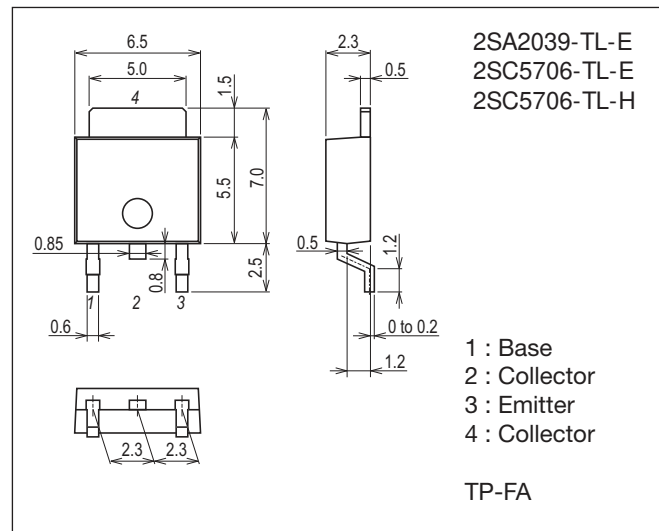

Product & Package Information

- Package : TP
- JEITA, JEDEC : SC-64, TO-251
- Minimum Packing Quantity : 500 pcs./bag

Marking (TP, TP-FA)

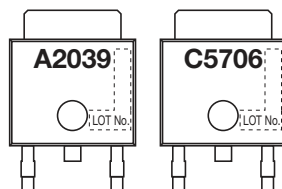

- Package : TP-FA
- JEITA, JEDEC : SC-63, TO-252
- Minimum Packing Quantity : 700 pcs./reel

Packing Type (TP-FA) : TL Electrical Connection

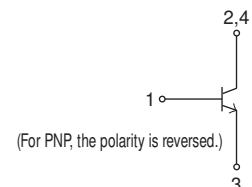
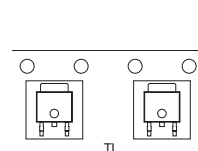

2SA2039 / 2SC5706

Continued from preceding page.

Parameter	Symbol	Conditions	Ratings	Unit
Base Current	I_B		(-)1.2	A
Collector Dissipation	P_C		0.8	W
		$T_C=25^\circ\text{C}$	15	W
Junction Temperature	T_j		150	$^\circ\text{C}$
Storage Temperature	T_{stg}		-55 to +150	$^\circ\text{C}$

Stresses exceeding Maximum Ratings may damage the device. Maximum Ratings are stress ratings only. Functional operation above the Recommended Operating Conditions is not implied. Extended exposure to stresses above the Recommended Operating Conditions may affect device reliability.

Electrical Characteristics at $T_a=25^\circ\text{C}$

Parameter	Symbol	Conditions	Ratings			Unit
			min	typ	max	
Collector Cutoff Current	I_{CBO}	$V_{CB}=(-)40\text{V}, I_E=0\text{A}$			(-)1	μA
Emitter Cutoff Current	I_{EBO}	$V_{EB}=(-)4\text{V}, I_C=0\text{A}$			(-)1	μA
DC Current Gain	h_{FE}	$V_{CE}=(-)2\text{V}, I_C=(-)500\text{mA}$	200		560	
Gain-Bandwidth Product	f_T	$V_{CE}=(-)10\text{V}, I_C=(-)500\text{mA}$		(360)400		MHz
Output Capacitance	C_{ob}	$V_{CB}=(-)10\text{V}, f=1\text{MHz}$		(24)15		pF
Collector-to-Emitter Saturation Voltage	$V_{CE(sat)1}$	$I_C=(-)1\text{A}, I_B=(-)50\text{mA}$		(-115)90	(-195)135	mV
	$V_{CE(sat)2}$	$I_C=(-)2\text{A}, I_B=(-)100\text{mA}$		(-255)160	(-430)240	mV
Base-to-Emitter Saturation Voltage	$V_{BE(sat)}$	$V_{CE}=(-)2\text{V}, I_B=(-)100\text{mA}$		(-)0.89	(-)1.2	V
Collector-to-Base Breakdown Voltage	$V_{(BR)CBO}$	$I_C=(-)10\mu\text{A}, I_E=0\text{A}$	(-50)100			V
Collector-to-Emitter Breakdown Voltage	$V_{(BR)CES}$	$I_C=(-)100\mu\text{A}, R_{BE}=\infty$	(-50)100			V
Collector-to-Emitter Breakdown Voltage	$V_{(BR)CEO}$	$I_C=(-)1\text{mA}, R_{BE}=\infty$	(-)50			V
Emitter-to-Base Breakdown Voltage	$V_{(BR)EBO}$	$I_E=(-)10\mu\text{A}, I_C=0\text{A}$	(-)6			V
Turn-On Time	t_{on}			(30)35		ns
Storage Time	t_{stg}	See specified Test Circuit.		(230)300		ns
Fall Time	t_f			(15)20		ns

Switching Time Test Circuit

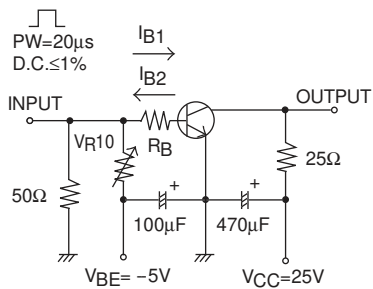

$$I_C = 10I_{B1} = -10I_{B2} = 1\text{A}$$

For PNP, the polarity is reversed.

Ordering Information

Device	Package	Shipping	memo
2SA2039-E	TP	500pcs./bag	Pb Free
2SC5706-E	TP	500pcs./bag	
2SC5706-H	TP	500pcs./bag	Pb Free & Halogen Free
2SA2039-TL-E	TP-FA	700pcs./reel	Pb Free
2SC5706-TL-E	TP-FA	700pcs./reel	
2SC5706-TL-H	TP-FA	700pcs./reel	Pb Free & Halogen Free

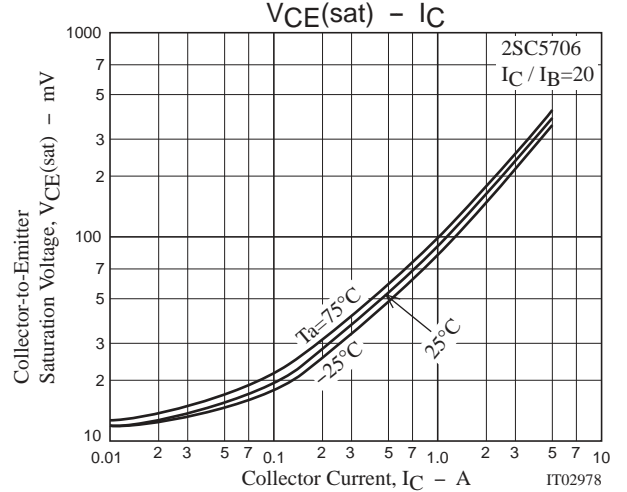
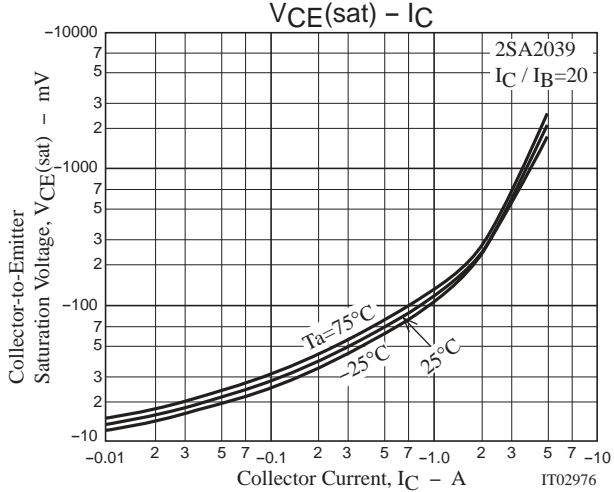
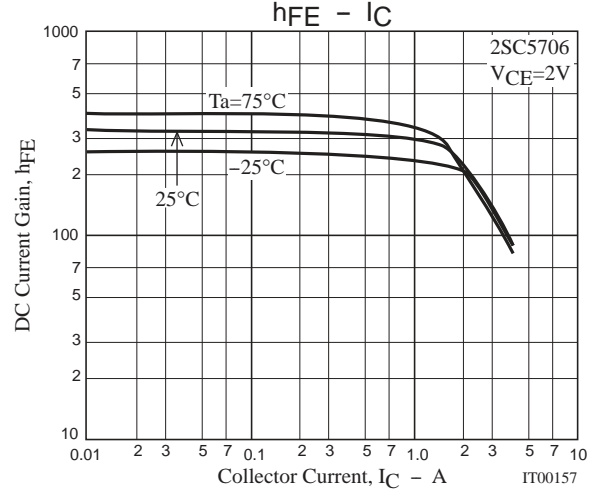
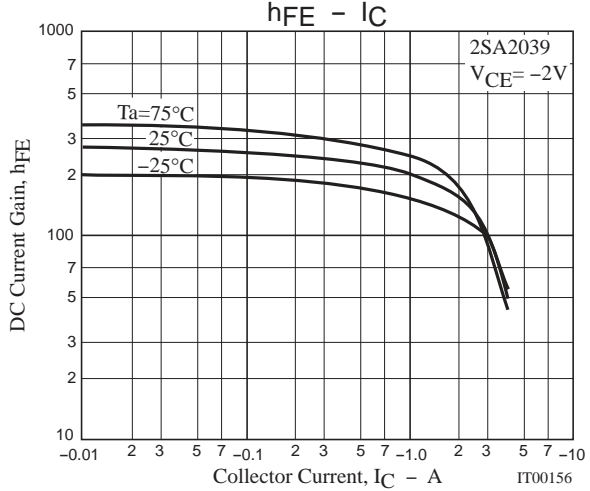
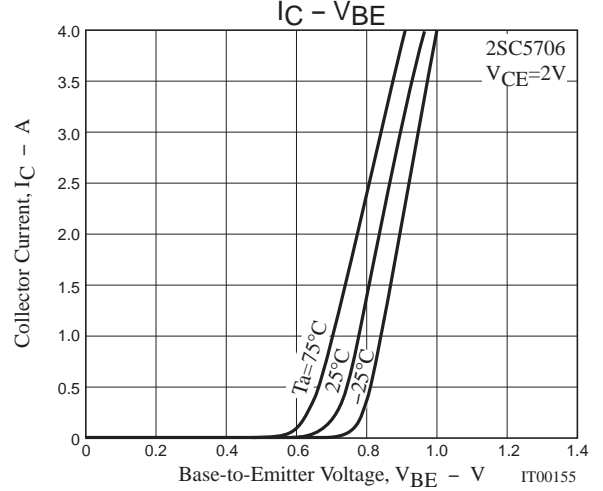
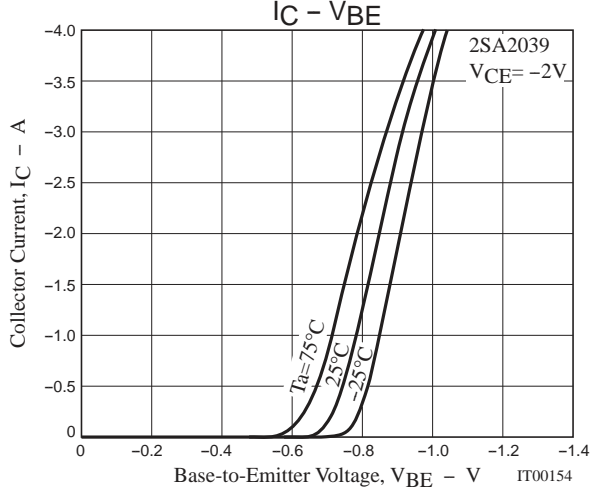
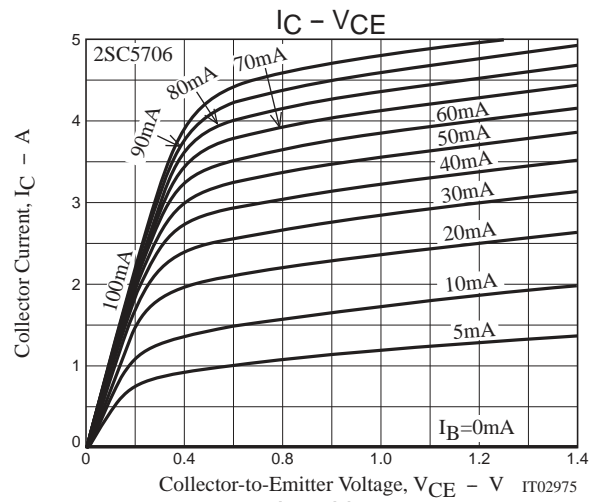
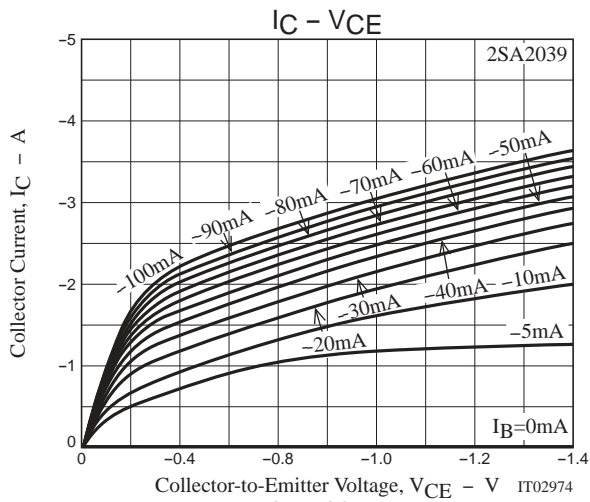

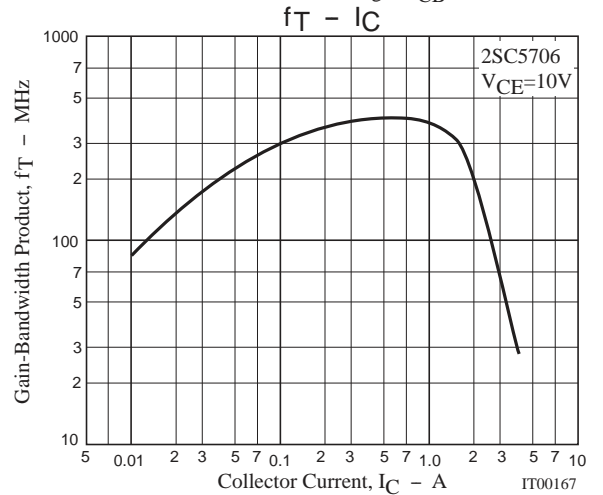
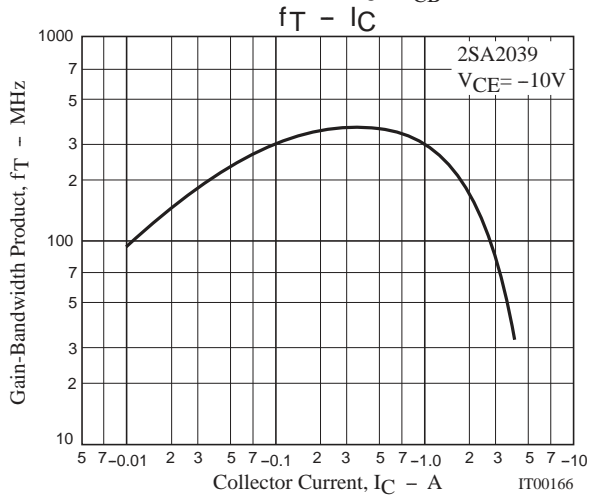
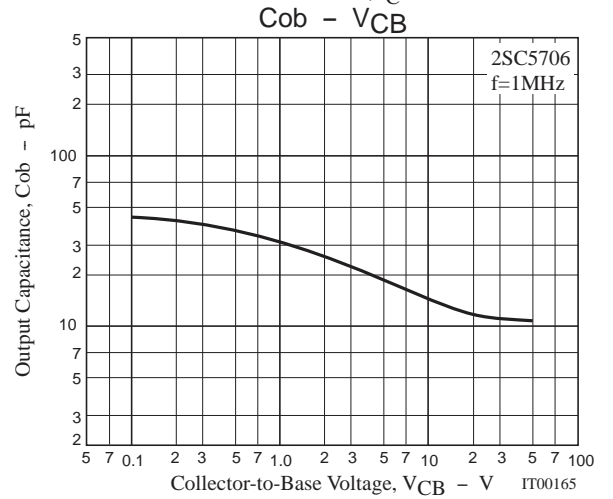
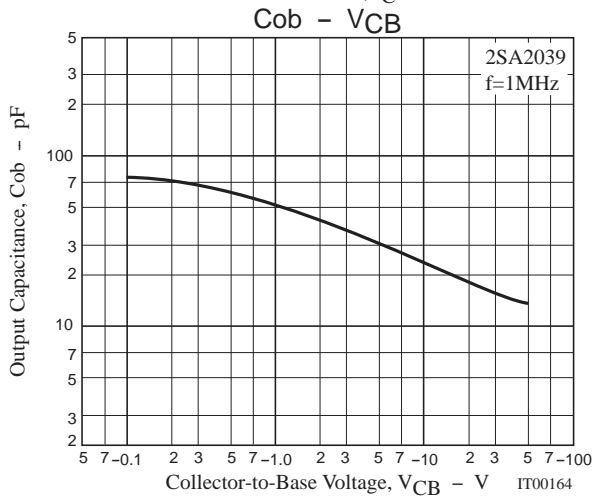
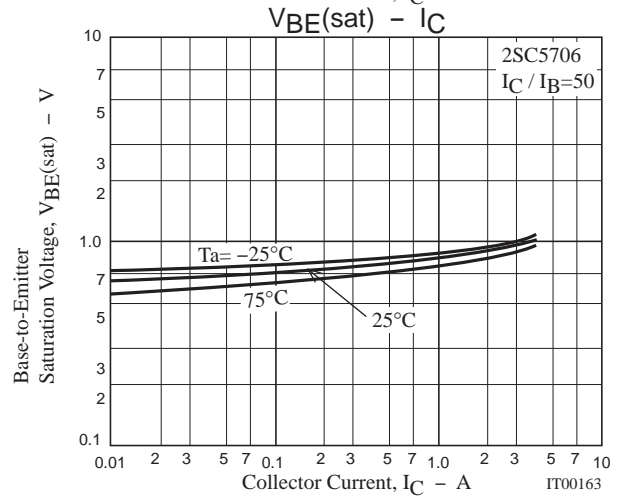
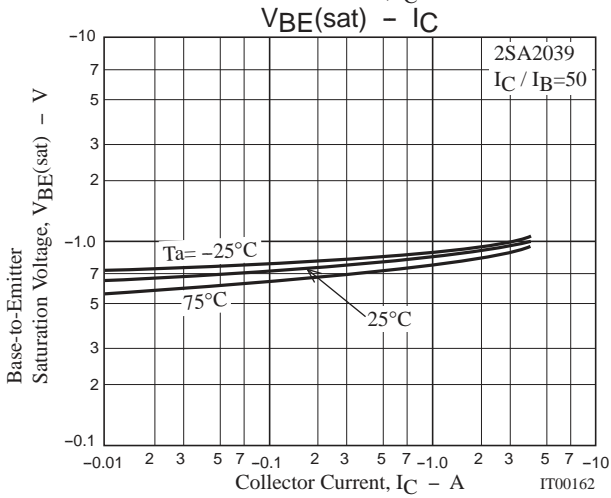
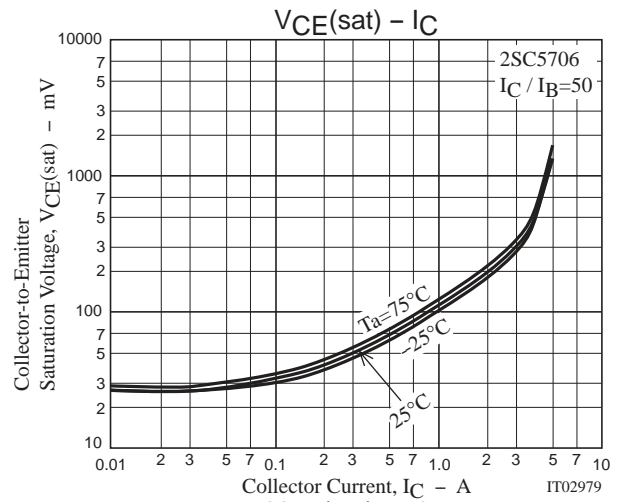
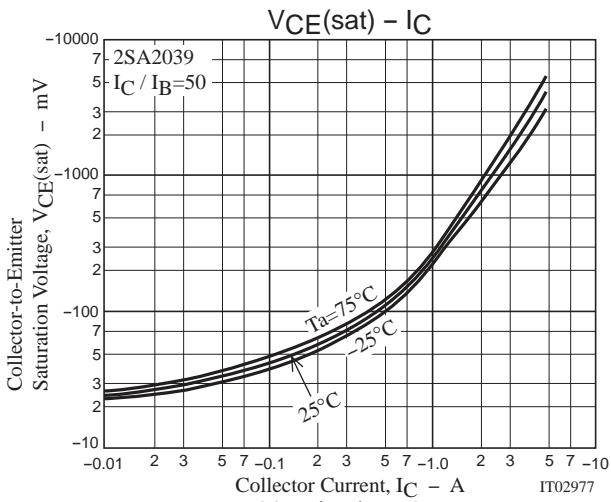

2SA2039 / 2SC5706

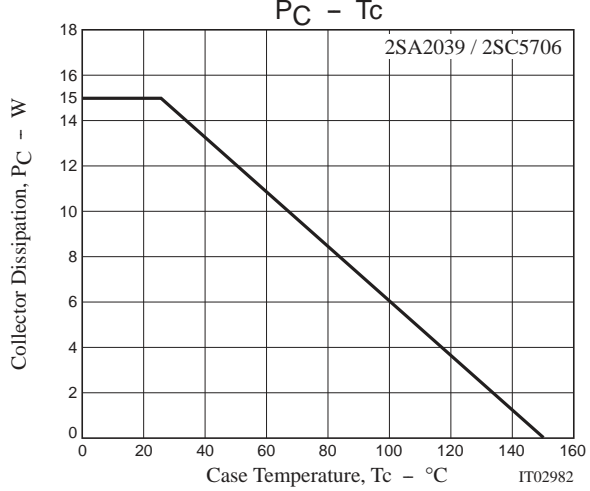
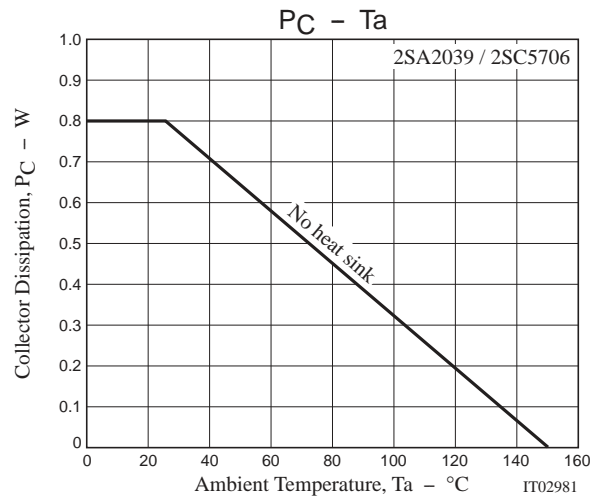
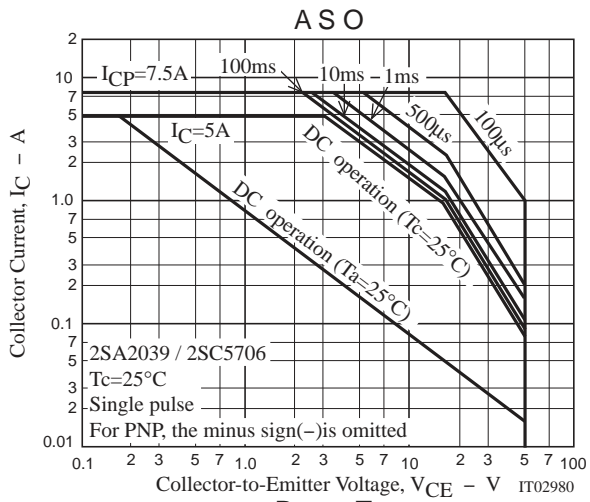

Taping Specification

2SA2039-TL-E, 2SC5706-TL-E, 2SC5706-TL-H

Packing Format

Package Name	Carrier Tape Type	Maximum Number of devices contained (pcs)			Packing format	
		Reel	Inner box	Outer box	Inner BOX (C-1)	Outer BOX (A-7)
TP-FA	TP	700	2,100	12,600	3 reels contained Dimensions:mm (external) 183×72×185	6 inner boxes contained Dimensions:mm (external) 440×195×210

Packing method

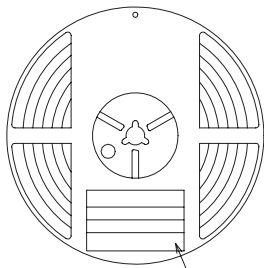

Type No.
LOT No.
Quantity
Origin

Reel label

Reel label, Inner box label (unit:mm)

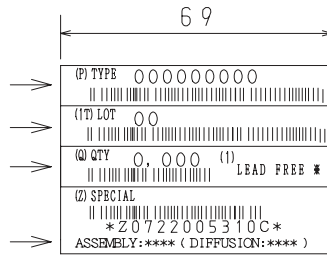

Outer box label

It is a label at the time of factory shipments. The form of a label may change in physical distribution process.

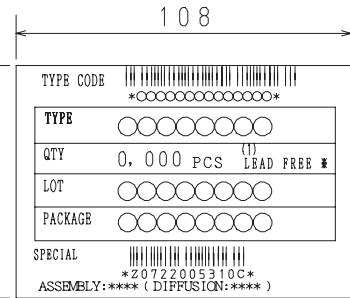

NOTE (1)

The LEAD FREE * description shows that the surface treatment of the terminal is lead free.

Label	JEITA Phase
LEAD FREE 3	JEITA Phase 3A
LEAD FREE 4	JEITA Phase 3

Taping configuration

1. Carrier tape size (unit:mm)

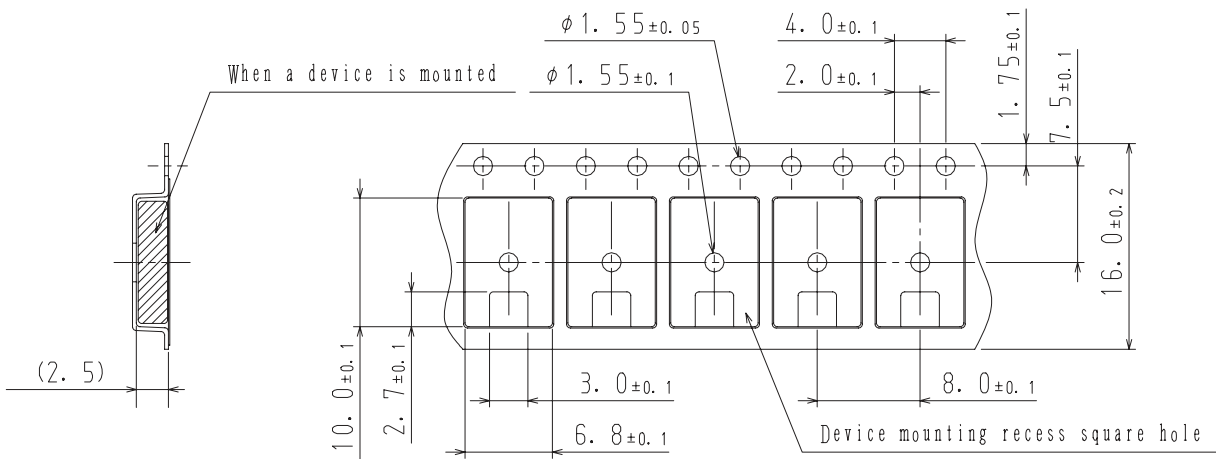

2. Device placement direction

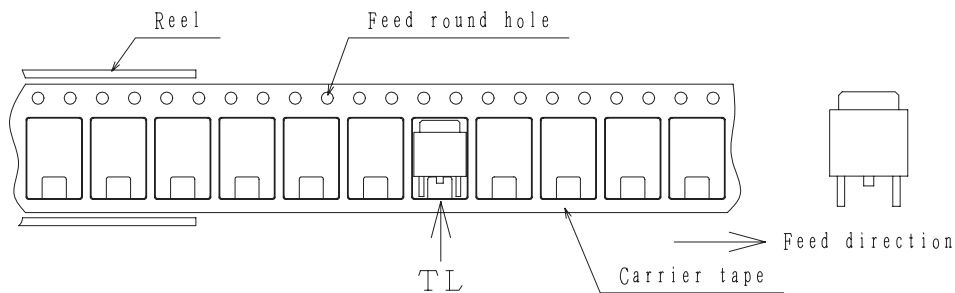

Those with one electrode terminal on the feed hole side.....TL

Outline Drawing

2SA2039-TL-E, 2SC5706-TL-E, 2SC5706-TL-H

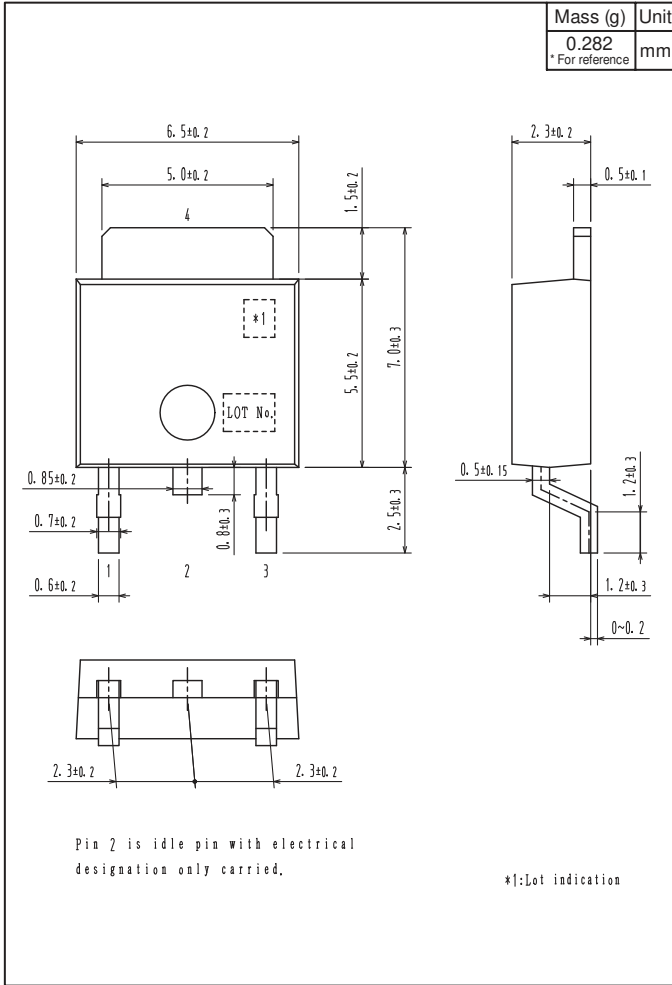

Land Pattern Example

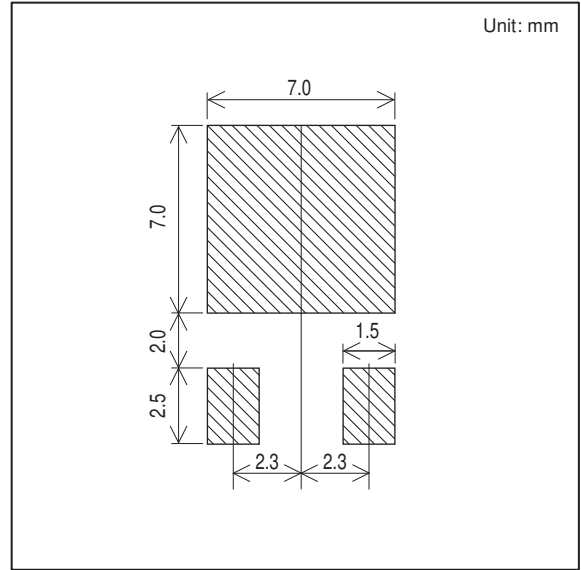

Bag Packing Specification

2SA2039-E, 2SC5706-E, 2SC5706-H

1. Packing Format

Package Name	Maximum Number of devices contained (pcs)			
	Bag	Inner box	Outer box	
TP	500	B-1	A-1	A-2
		10,000	50,000	30,000
	Packing format (Dimensions:mm (external))			
		Inner box	Outer box	
		B-1	A-1	A-2
		445×225×55	470×250×300	470×250×190

2. Bag dimensions
(unit:mm)

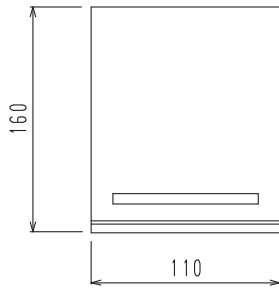

3. Bag label, Inner box label
(unit:mm)

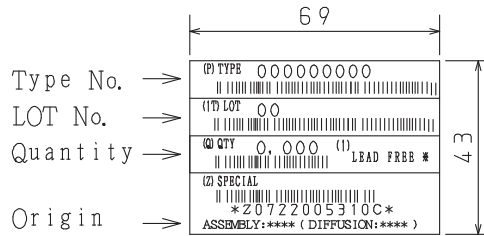

4. Outer box label
(unit:mm)

It is a label at the time of factory shipments.
The form of a label may change in physical distribution process.

NOTE (1)

The LEAD FREE * description shows that the surface treatment of the terminal is lead free.

Label	JEITA Phase
LEAD FREE 3	JEITA Phase 3A
LEAD FREE 4	JEITA Phase 3

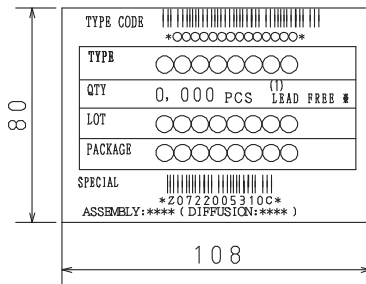

Outline Drawing

2SA2039-E, 2SC5706-E, 2SC5706-H

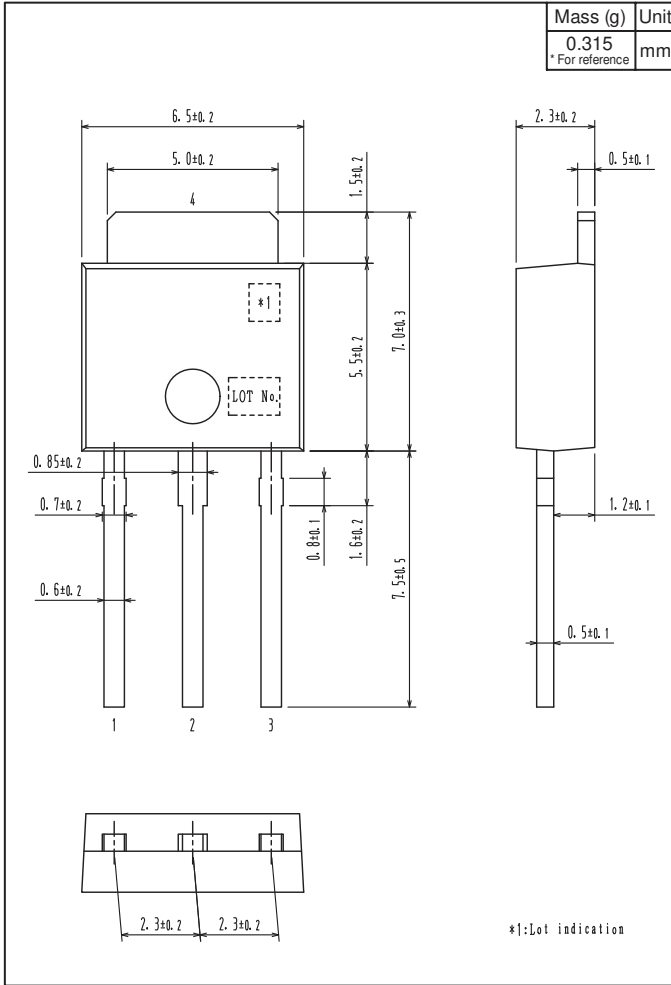

ON Semiconductor and the ON logo are registered trademarks of Semiconductor Components Industries, LLC (SCILLC). SCILLC owns the rights to a number of patents, trademarks, copyrights, trade secrets, and other intellectual property. A listing of SCILLC's product/patent coverage may be accessed at www.onsemi.com/site/pdf/Patent-Marking.pdf. SCILLC reserves the right to make changes without further notice to any products herein. SCILLC makes no warranty, representation or guarantee regarding the suitability of its products for any particular purpose, nor does SCILLC assume any liability arising out of the application or use of any product or circuit, and specifically disclaims any and all liability, including without limitation special, consequential or incidental damages. "Typical" parameters which may be provided in SCILLC data sheets and/or specifications can and do vary in different applications and actual performance may vary over time. All operating parameters, including "Typicals" must be validated for each customer application by customer's technical experts. SCILLC does not convey any license under its patent rights nor the rights of others. SCILLC products are not designed, intended, or authorized for use as components in systems intended for surgical implant into the body, or other applications intended to support or sustain life, or for any other application in which the failure of the SCILLC product could create a situation where personal injury or death may occur. Should Buyer purchase or use SCILLC products for any such unintended or unauthorized application, Buyer shall indemnify and hold SCILLC and its officers, employees, subsidiaries, affiliates, and distributors harmless against all claims, costs, damages, and expenses, and reasonable attorney fees arising out of, directly or indirectly, any claim of personal injury or death associated with such unintended or unauthorized use, even if such claim alleges that SCILLC was negligent regarding the design or manufacture of the part. SCILLC is an Equal Opportunity/Affirmative Action Employer. This literature is subject to all applicable copyright laws and is not for resale in any manner.