

IGBT

High speed 5 FAST IGBT in TRENCHSTOP™ 5 technology copacked with RAPID 1 fast and soft antiparallel diode

IKP30N65F5

650V DuoPack IGBT and diode
High speed switching series fifth generation

Data sheet

High speed 5 FAST IGBT in TRENCHSTOP™ 5 technology copacked with RAPID 1 fast and soft antiparallel diode

Features and Benefits:

High speed F5 technology offering

- Best-in-Class efficiency in hard switching and resonant topologies
- 650V breakdown voltage
- Low gate charge Q_G
- IGBT copacked with RAPID 1 fast and soft antiparallel diode
- Maximum junction temperature 175°C
- Qualified according to JEDEC for target applications
- Pb-free lead plating; RoHS compliant
- Complete product spectrum and PSpice Models:
<http://www.infineon.com/igbt/>

Applications:

- Solar converters
- Uninterruptible power supplies
- Welding converters
- Mid to high range switching frequency converters

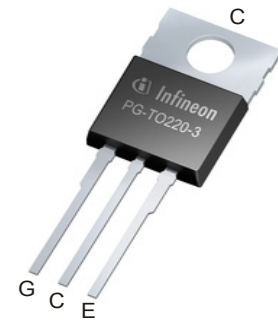
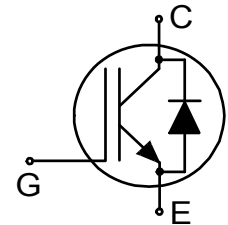

Key Performance and Package Parameters

Type	V_{CE}	I_C	$V_{CEsat}, T_{vj}=25^{\circ}C$	T_{vjmax}	Marking	Package
IKP30N65F5	650V	30A	1.6V	175°C	K30EF5	PG-TO220-3



Table of Contents

Description 2

Table of Contents 3

Maximum Ratings 4

Thermal Resistance 4

Electrical Characteristics 5

Electrical Characteristics Diagrams 8

Package Drawing15

Testing Conditions16

Revision History17

Disclaimer17

Maximum Ratings

For optimum lifetime and reliability, Infineon recommends operating conditions that do not exceed 80% of the maximum ratings stated in this datasheet.

Parameter	Symbol	Value	Unit
Collector-emitter voltage, $T_{vj} \geq 25^{\circ}\text{C}$	V_{CE}	650	V
DC collector current, limited by T_{vjmax} $T_C = 25^{\circ}\text{C}$ $T_C = 100^{\circ}\text{C}$	I_C	55.0 35.0	A
Pulsed collector current, t_p limited by T_{vjmax}	I_{Cpuls}	90.0	A
Turn off safe operating area $V_{CE} \leq 650\text{V}$, $T_{vj} \leq 175^{\circ}\text{C}$, $t_p = 1\mu\text{s}$	-	90.0	A
Diode forward current, limited by T_{vjmax} $T_C = 25^{\circ}\text{C}$ $T_C = 100^{\circ}\text{C}$	I_F	36.0 21.0	A
Diode pulsed current, t_p limited by T_{vjmax}	I_{Fpuls}	90.0	A
Gate-emitter voltage Transient Gate-emitter voltage ($t_p \leq 10\mu\text{s}$, $D < 0.010$)	V_{GE}	± 20 ± 30	V
Power dissipation $T_C = 25^{\circ}\text{C}$ Power dissipation $T_C = 100^{\circ}\text{C}$	P_{tot}	188.0 93.0	W
Operating junction temperature	T_{vj}	-40...+175	$^{\circ}\text{C}$
Storage temperature	T_{stg}	-55...+150	$^{\circ}\text{C}$
Soldering temperature, wave soldering 1.6mm (0.063in.) from case for 10s		260	$^{\circ}\text{C}$
Mounting torque, M3 screw Maximum of mounting processes: 3	M	0.6	Nm

Thermal Resistance

Parameter	Symbol	Conditions	Max. Value	Unit
Characteristic				
IGBT thermal resistance, junction - case	$R_{th(j-c)}$		0.80	K/W
Diode thermal resistance, junction - case	$R_{th(j-c)}$		1.80	K/W
Thermal resistance junction - ambient	$R_{th(j-a)}$		62	K/W

Electrical Characteristic, at $T_{vj} = 25^{\circ}\text{C}$, unless otherwise specified

Parameter	Symbol	Conditions	Value			Unit
			min.	typ.	max.	
Static Characteristic						
Collector-emitter breakdown voltage	$V_{(BR)CES}$	$V_{GE} = 0\text{V}, I_C = 0.20\text{mA}$	650	-	-	V
Collector-emitter saturation voltage	V_{CEsat}	$V_{GE} = 15.0\text{V}, I_C = 30.0\text{A}$ $T_{vj} = 25^{\circ}\text{C}$ $T_{vj} = 125^{\circ}\text{C}$ $T_{vj} = 175^{\circ}\text{C}$	-	1.60 1.80 1.90	2.10 -	V
Diode forward voltage	V_F	$V_{GE} = 0\text{V}, I_F = 15.0\text{A}$ $T_{vj} = 25^{\circ}\text{C}$ $T_{vj} = 125^{\circ}\text{C}$ $T_{vj} = 175^{\circ}\text{C}$	-	1.35 1.30 1.30	1.80 -	V
Gate-emitter threshold voltage	$V_{GE(th)}$	$I_C = 0.30\text{mA}, V_{CE} = V_{GE}$	3.2	4.0	4.8	V
Zero gate voltage collector current	I_{CES}	$V_{CE} = 650\text{V}, V_{GE} = 0\text{V}$ $T_{vj} = 25^{\circ}\text{C}$ $T_{vj} = 175^{\circ}\text{C}$	-	-	40.0 4000.0	μA
Gate-emitter leakage current	I_{GES}	$V_{CE} = 0\text{V}, V_{GE} = 20\text{V}$	-	-	100	nA
Transconductance	g_{fs}	$V_{CE} = 20\text{V}, I_C = 30.0\text{A}$	-	38.0	-	S

Electrical Characteristic, at $T_{vj} = 25^{\circ}\text{C}$, unless otherwise specified

Parameter	Symbol	Conditions	Value			Unit
			min.	typ.	max.	
Dynamic Characteristic						
Input capacitance	C_{ies}	$V_{CE} = 25\text{V}, V_{GE} = 0\text{V}, f = 1\text{MHz}$	-	1800	-	pF
Output capacitance	C_{oes}		-	45	-	
Reverse transfer capacitance	C_{res}		-	9	-	
Gate charge	Q_G	$V_{CC} = 520\text{V}, I_C = 30.0\text{A},$ $V_{GE} = 15\text{V}$	-	65.0	-	nC
Internal emitter inductance measured 5mm (0.197 in.) from case	L_E		-	7.0	-	nH

Switching Characteristic, Inductive Load

Parameter	Symbol	Conditions	Value			Unit
			min.	typ.	max.	
IGBT Characteristic, at $T_{vj} = 25^{\circ}\text{C}$						
Turn-on delay time	$t_{d(on)}$	$T_{vj} = 25^{\circ}\text{C},$ $V_{CC} = 400\text{V}, I_C = 15.0\text{A},$ $V_{GE} = 0.0/15.0\text{V},$ $R_{G(on)} = 23.0\Omega, R_{G(off)} = 23.0\Omega,$ $L_{\sigma} = 30\text{nH}, C_{\sigma} = 30\text{pF}$ L_{σ}, C_{σ} from Fig. E Energy losses include "tail" and diode reverse recovery.	-	19	-	ns
Rise time	t_r		-	9	-	ns
Turn-off delay time	$t_{d(off)}$		-	170	-	ns
Fall time	t_f		-	10	-	ns
Turn-on energy	E_{on}		-	0.28	-	mJ
Turn-off energy	E_{off}		-	0.07	-	mJ
Total switching energy	E_{ts}		-	0.35	-	mJ

Turn-on delay time	$t_{d(on)}$	$T_{vj} = 25^{\circ}\text{C}$, $V_{CC} = 400\text{V}$, $I_C = 5.0\text{A}$, $V_{GE} = 0.0/15.0\text{V}$, $R_{G(on)} = 23.0\Omega$, $R_{G(off)} = 23.0\Omega$, $L\sigma = 30\text{nH}$, $C\sigma = 30\text{pF}$ $L\sigma$, $C\sigma$ from Fig. E Energy losses include "tail" and diode reverse recovery.	-	18	-	ns
Rise time	t_r		-	4	-	ns
Turn-off delay time	$t_{d(off)}$		-	174	-	ns
Fall time	t_f		-	15	-	ns
Turn-on energy	E_{on}		-	0.09	-	mJ
Turn-off energy	E_{off}		-	0.02	-	mJ
Total switching energy	E_{ts}		-	0.11	-	mJ

Diode Characteristic, at $T_{vj} = 25^{\circ}\text{C}$

Diode reverse recovery time	t_{rr}	$T_{vj} = 25^{\circ}\text{C}$, $V_R = 400\text{V}$, $I_F = 15.0\text{A}$, $di_F/dt = 1600\text{A}/\mu\text{s}$	-	55	-	ns
Diode reverse recovery charge	Q_{rr}		-	0.41	-	μC
Diode peak reverse recovery current	I_{rrm}		-	14.4	-	A
Diode peak rate of fall of reverse recovery current during t_b	di_{rr}/dt		-	-399	-	$\text{A}/\mu\text{s}$
Diode reverse recovery time	t_{rr}	$T_{vj} = 25^{\circ}\text{C}$, $V_R = 400\text{V}$, $I_F = 5.0\text{A}$, $di_F/dt = 1300\text{A}/\mu\text{s}$	-	29	-	ns
Diode reverse recovery charge	Q_{rr}		-	0.22	-	μC
Diode peak reverse recovery current	I_{rrm}		-	12.6	-	A
Diode peak rate of fall of reverse recovery current during t_b	di_{rr}/dt		-	-820	-	$\text{A}/\mu\text{s}$

Switching Characteristic, Inductive Load

Parameter	Symbol	Conditions	Value			Unit
			min.	typ.	max.	

IGBT Characteristic, at $T_{vj} = 150^{\circ}\text{C}$

Turn-on delay time	$t_{d(on)}$	$T_{vj} = 150^{\circ}\text{C}$, $V_{CC} = 400\text{V}$, $I_C = 15.0\text{A}$, $V_{GE} = 0.0/15.0\text{V}$, $R_{G(on)} = 23.0\Omega$, $R_{G(off)} = 23.0\Omega$, $L\sigma = 30\text{nH}$, $C\sigma = 30\text{pF}$ $L\sigma$, $C\sigma$ from Fig. E Energy losses include "tail" and diode reverse recovery.	-	18	-	ns
Rise time	t_r		-	10	-	ns
Turn-off delay time	$t_{d(off)}$		-	203	-	ns
Fall time	t_f		-	3	-	ns
Turn-on energy	E_{on}		-	0.38	-	mJ
Turn-off energy	E_{off}		-	0.12	-	mJ
Total switching energy	E_{ts}		-	0.50	-	mJ
Turn-on delay time	$t_{d(on)}$	$T_{vj} = 150^{\circ}\text{C}$, $V_{CC} = 400\text{V}$, $I_C = 5.0\text{A}$, $V_{GE} = 0.0/15.0\text{V}$, $R_{G(on)} = 23.0\Omega$, $R_{G(off)} = 23.0\Omega$, $L\sigma = 30\text{nH}$, $C\sigma = 30\text{pF}$ $L\sigma$, $C\sigma$ from Fig. E Energy losses include "tail" and diode reverse recovery.	-	16	-	ns
Rise time	t_r		-	5	-	ns
Turn-off delay time	$t_{d(off)}$		-	230	-	ns
Fall time	t_f		-	9	-	ns
Turn-on energy	E_{on}		-	0.15	-	mJ
Turn-off energy	E_{off}		-	0.04	-	mJ
Total switching energy	E_{ts}		-	0.19	-	mJ

Diode Characteristic, at $T_{vj} = 150^{\circ}\text{C}$

Diode reverse recovery time	t_{rr}	$T_{vj} = 150^{\circ}\text{C},$ $V_R = 400\text{V},$ $I_F = 15.0\text{A},$ $di_F/dt = 1600\text{A}/\mu\text{s}$	-	83	-	ns
Diode reverse recovery charge	Q_{rr}		-	0.90	-	μC
Diode peak reverse recovery current	I_{rrm}		-	19.3	-	A
Diode peak rate of fall of reverse recovery current during t_b	di_{rr}/dt		-	-288	-	$\text{A}/\mu\text{s}$
Diode reverse recovery time	t_{rr}	$T_{vj} = 150^{\circ}\text{C},$ $V_R = 400\text{V},$ $I_F = 5.0\text{A},$ $di_F/dt = 1300\text{A}/\mu\text{s}$	-	51	-	ns
Diode reverse recovery charge	Q_{rr}		-	0.49	-	μC
Diode peak reverse recovery current	I_{rrm}		-	17.7	-	A
Diode peak rate of fall of reverse recovery current during t_b	di_{rr}/dt		-	-538	-	$\text{A}/\mu\text{s}$

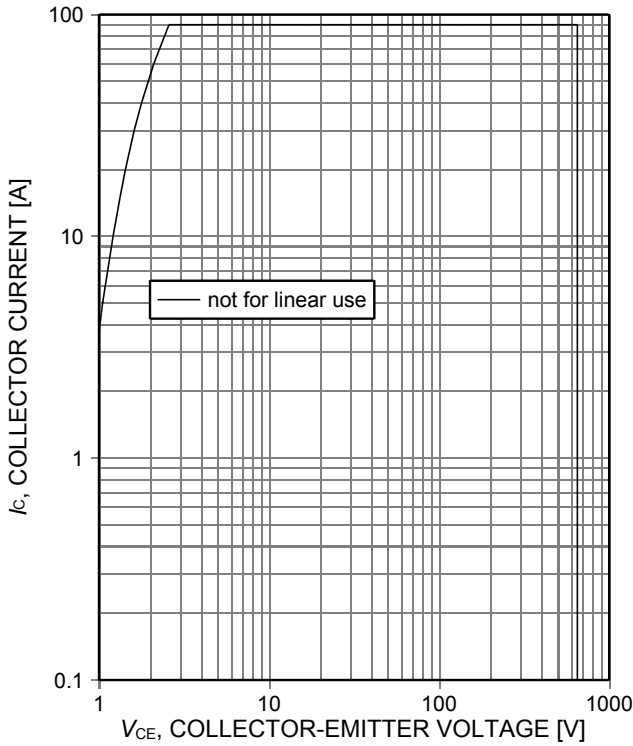

Figure 1. **Forward bias safe operating area**
 ($D=0$, $T_C=25^\circ\text{C}$, $T_{vj}\leq 175^\circ\text{C}$, $V_{GE}=15\text{V}$, $t_p=1\mu\text{s}$.
 Recommended use at $V_{GE}\geq 7.5\text{V}$)

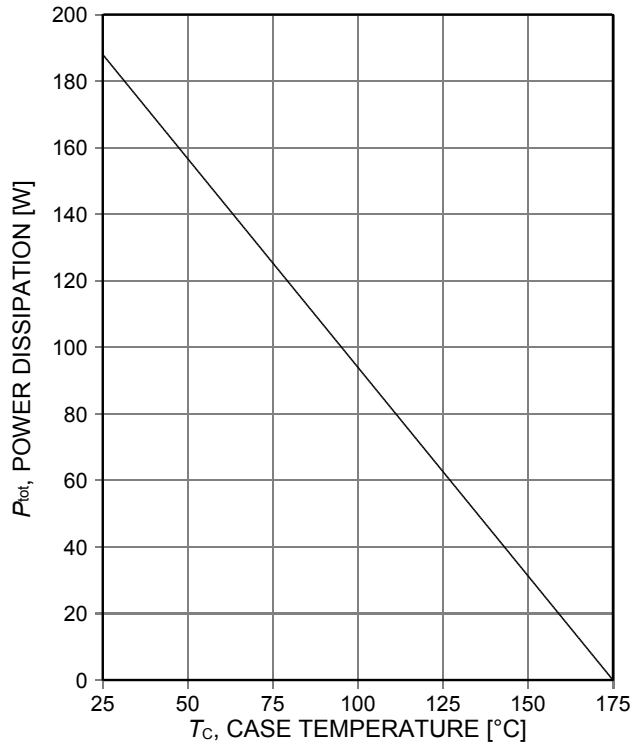

Figure 2. **Power dissipation as a function of case temperature**
 ($T_{vj}\leq 175^\circ\text{C}$)

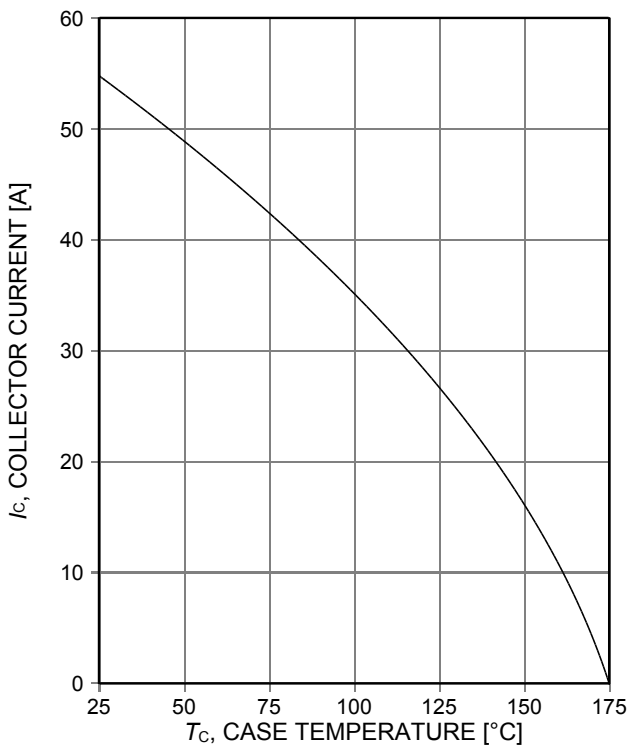

Figure 3. **Collector current as a function of case temperature**
 ($V_{GE}\geq 15\text{V}$, $T_{vj}\leq 175^\circ\text{C}$)

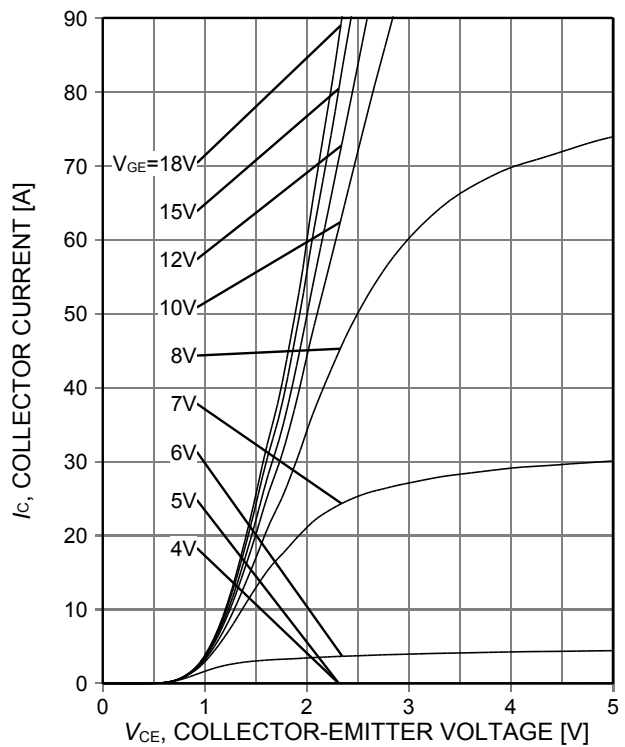

Figure 4. **Typical output characteristic**
 ($T_{vj}=25^\circ\text{C}$)

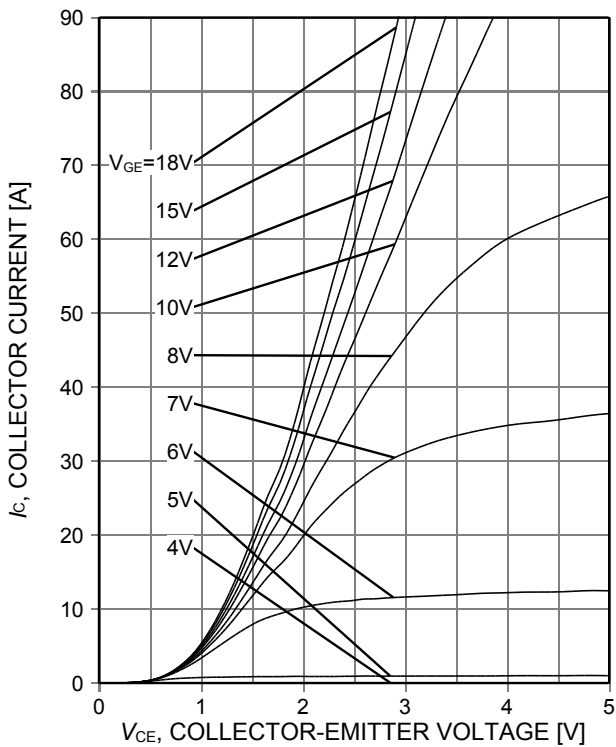

Figure 5. **Typical output characteristic**
($T_{vj}=150^{\circ}\text{C}$)

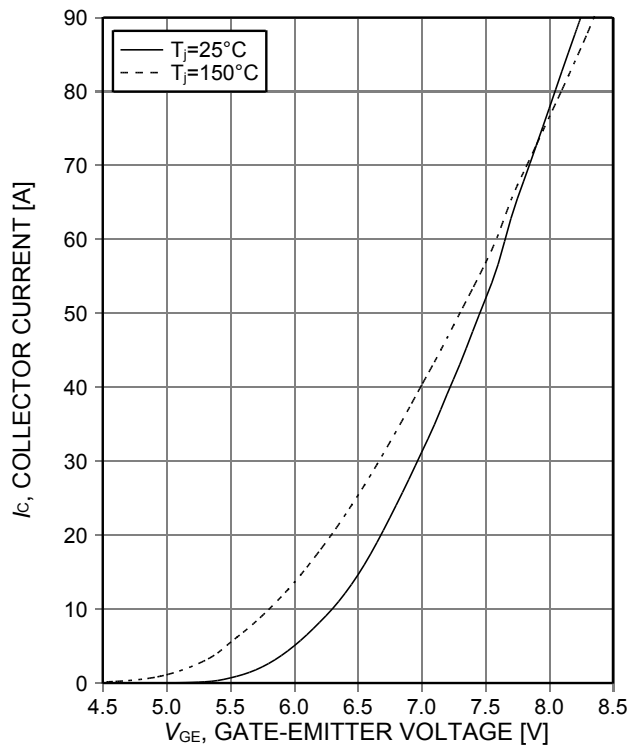

Figure 6. **Typical transfer characteristic**
($V_{CE}=20\text{V}$)

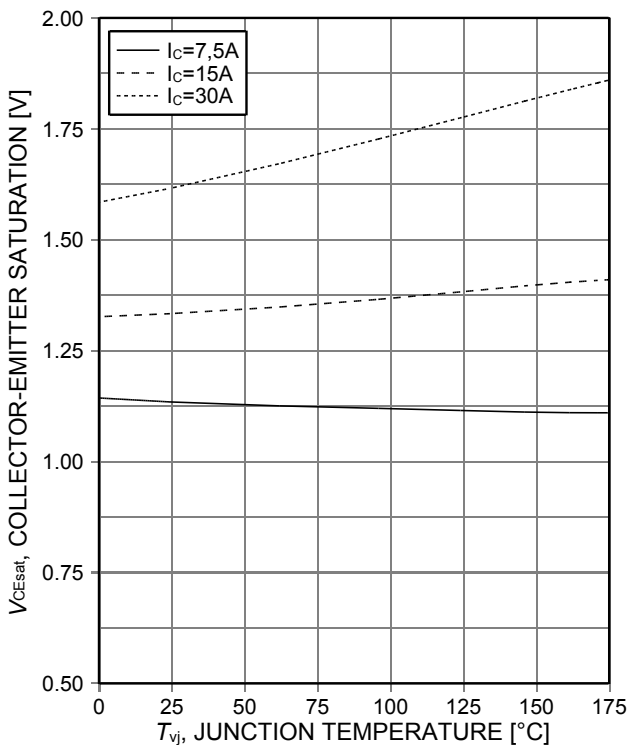

Figure 7. **Typical collector-emitter saturation voltage as a function of junction temperature**
($V_{GE}=15\text{V}$)

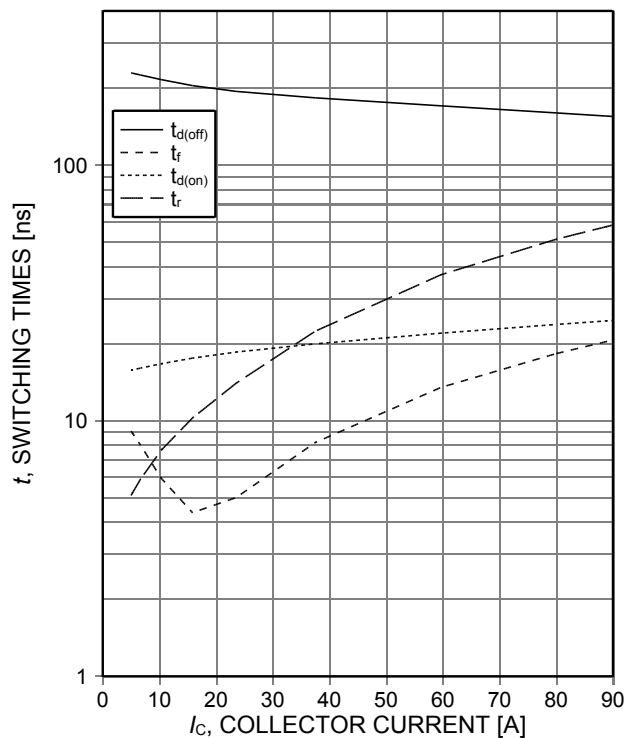

Figure 8. **Typical switching times as a function of collector current**
(inductive load, $T_{vj}=150^{\circ}\text{C}$, $V_{CE}=400\text{V}$, $V_{GE}=15/0\text{V}$, $r_G=23\Omega$, Dynamic test circuit in Figure E)

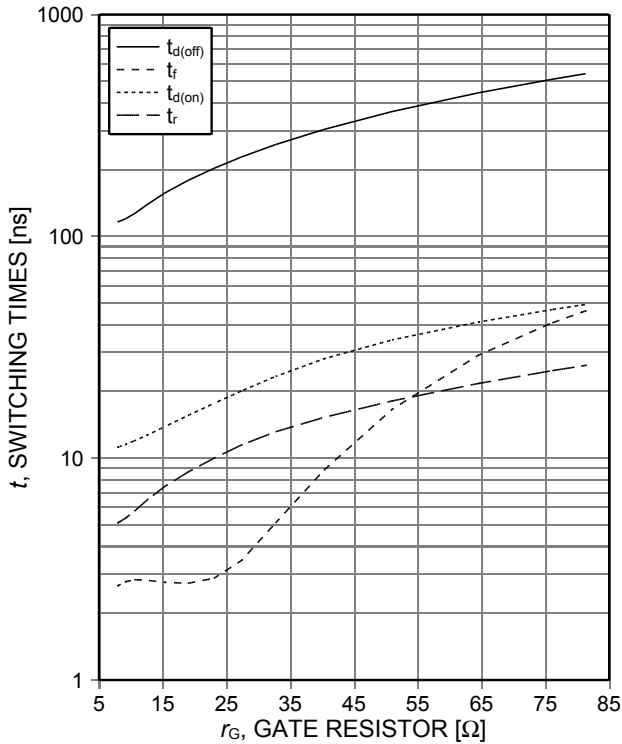

Figure 9. **Typical switching times as a function of gate resistor**
 (inductive load, $T_{vj}=150^{\circ}\text{C}$, $V_{CE}=400\text{V}$, $V_{GE}=15/0\text{V}$, $I_C=15\text{A}$, Dynamic test circuit in Figure E)

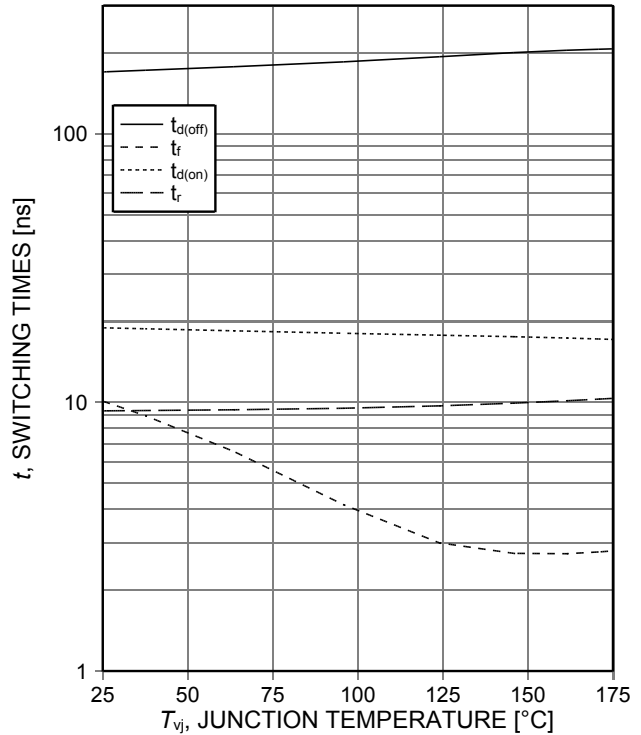

Figure 10. **Typical switching times as a function of junction temperature**
 (inductive load, $V_{CE}=400\text{V}$, $V_{GE}=15/0\text{V}$, $I_C=15\text{A}$, $r_G=23\Omega$, Dynamic test circuit in Figure E)

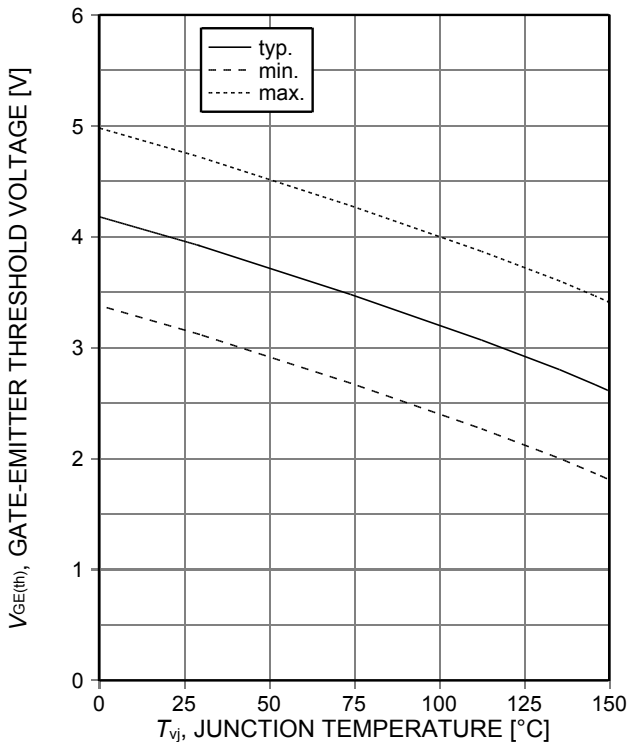

Figure 11. **Gate-emitter threshold voltage as a function of junction temperature**
 ($I_C=0.3\text{mA}$)

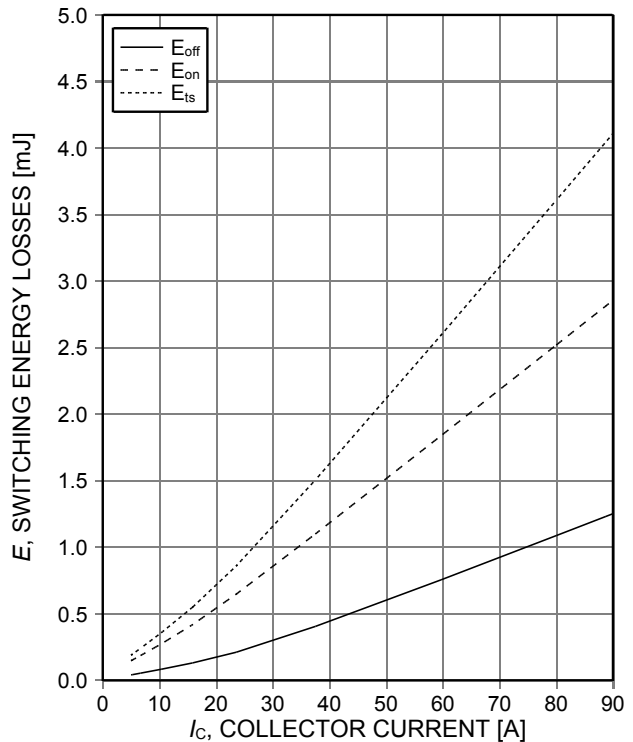

Figure 12. **Typical switching energy losses as a function of collector current**
 (inductive load, $T_{vj}=150^{\circ}\text{C}$, $V_{CE}=400\text{V}$, $V_{GE}=15/0\text{V}$, $r_G=23\Omega$, Dynamic test circuit in Figure E)

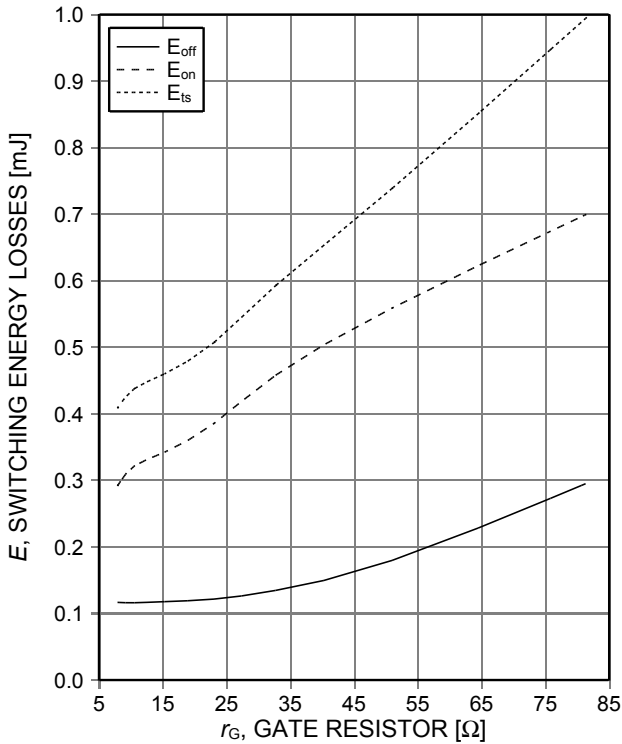

Figure 13. **Typical switching energy losses as a function of gate resistor**
 (inductive load, $T_{vj}=150^{\circ}\text{C}$, $V_{CE}=400\text{V}$, $V_{GE}=15/0\text{V}$, $I_C=15\text{A}$, Dynamic test circuit in Figure E)

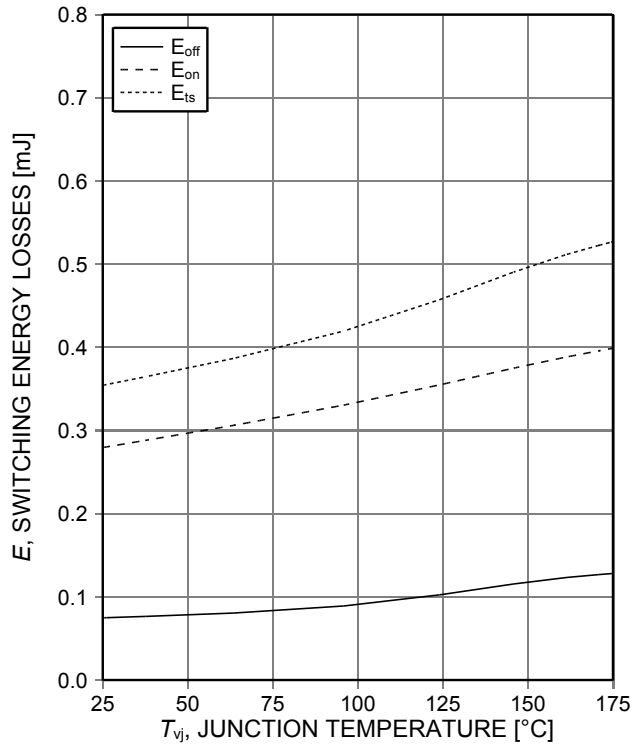

Figure 14. **Typical switching energy losses as a function of junction temperature**
 (inductive load, $V_{CE}=400\text{V}$, $V_{GE}=15/0\text{V}$, $I_C=15\text{A}$, $r_G=23\Omega$, Dynamic test circuit in Figure E)

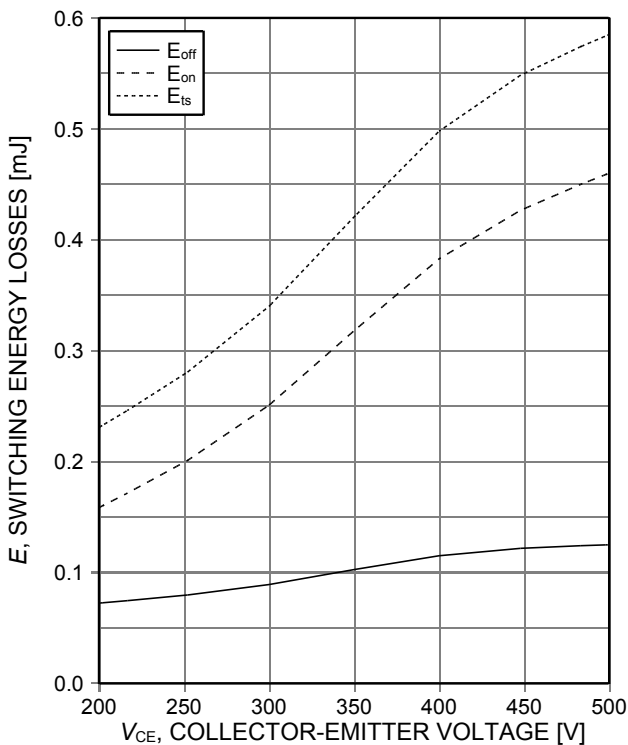

Figure 15. **Typical switching energy losses as a function of collector emitter voltage**
 (inductive load, $T_{vj}=150^{\circ}\text{C}$, $V_{GE}=15/0\text{V}$, $I_C=15\text{A}$, $r_G=23\Omega$, Dynamic test circuit in Figure E)

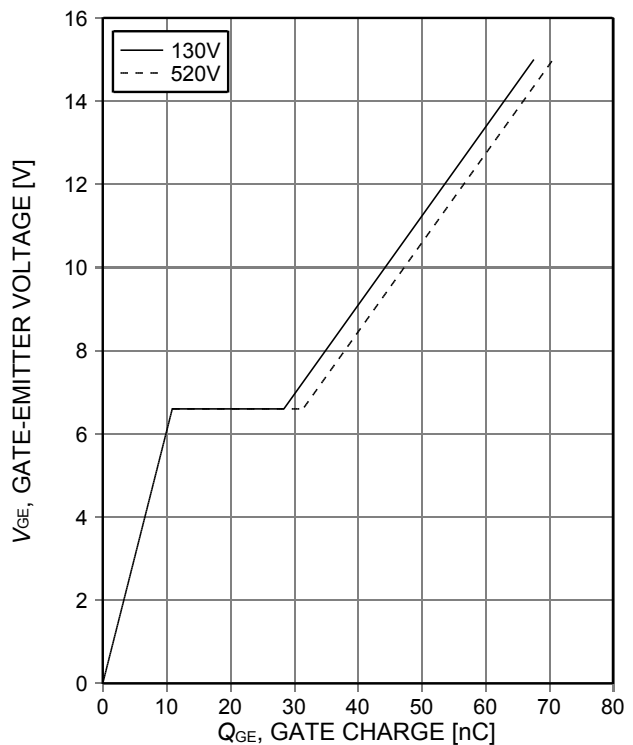

Figure 16. **Typical gate charge**
 ($I_C=30\text{A}$)

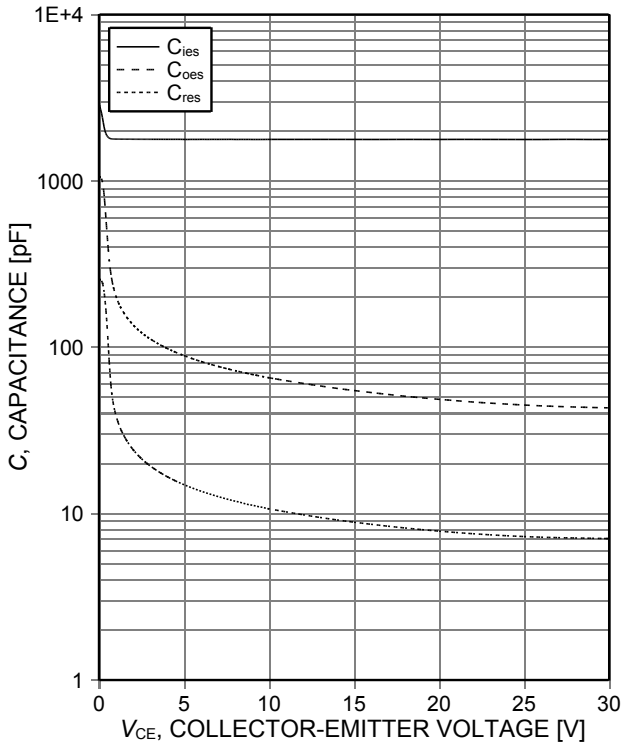

Figure 17. Typical capacitance as a function of collector-emitter voltage ($V_{GE}=0V, f=1MHz$)

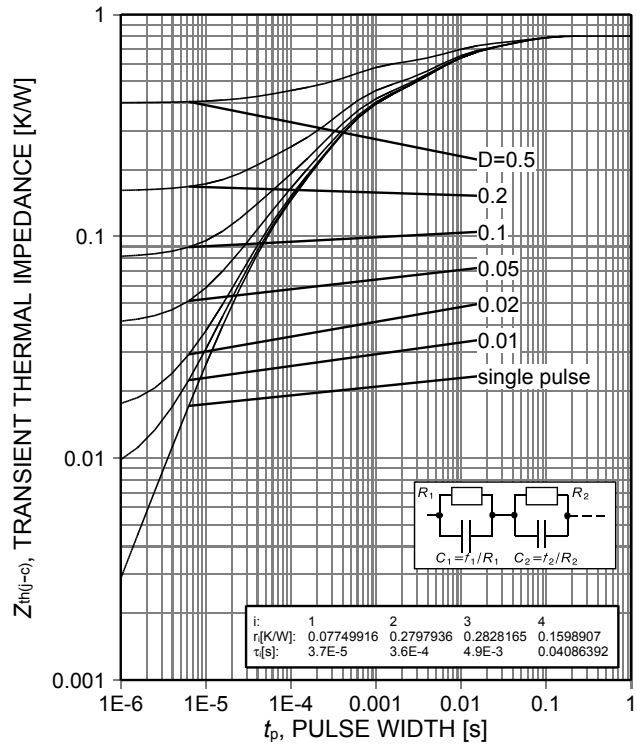

Figure 18. IGBT transient thermal impedance ($D=t_p/T$)

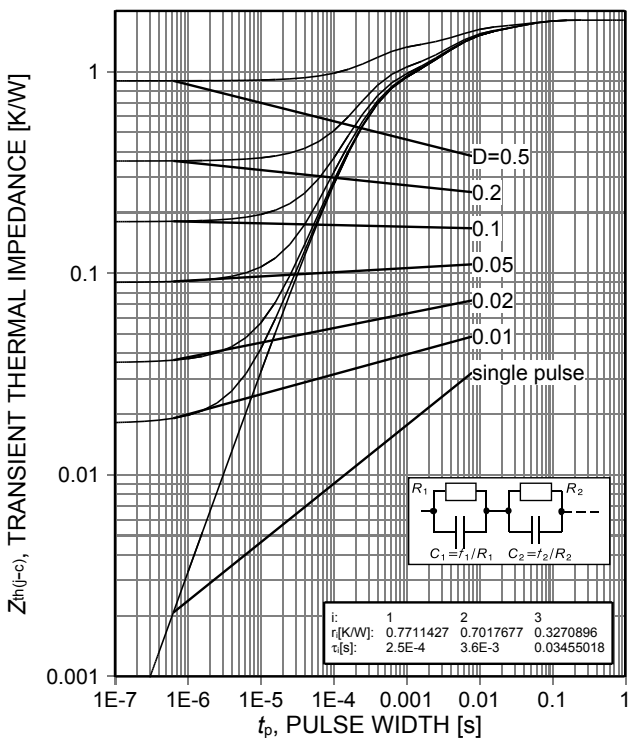

Figure 19. Diode transient thermal impedance as a function of pulse width ($D=t_p/T$)

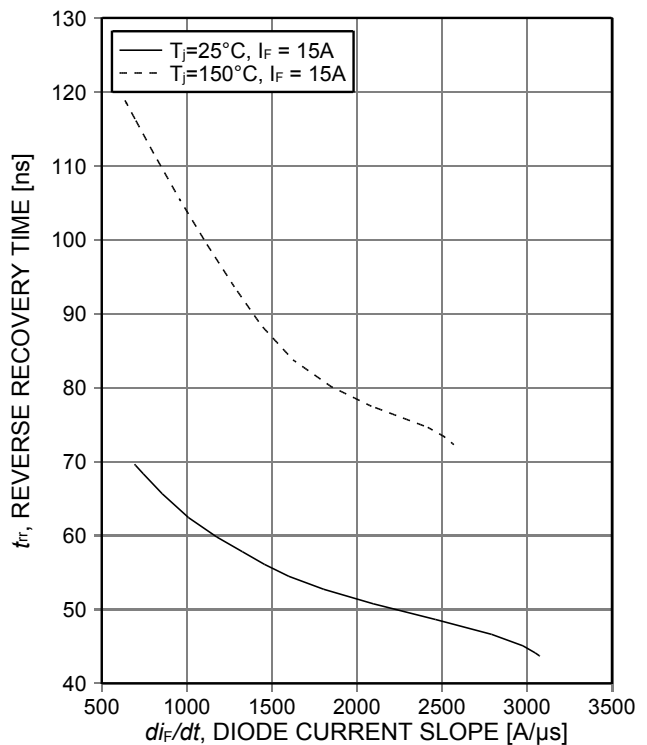

Figure 20. Typical reverse recovery time as a function of diode current slope ($V_R=400V$)

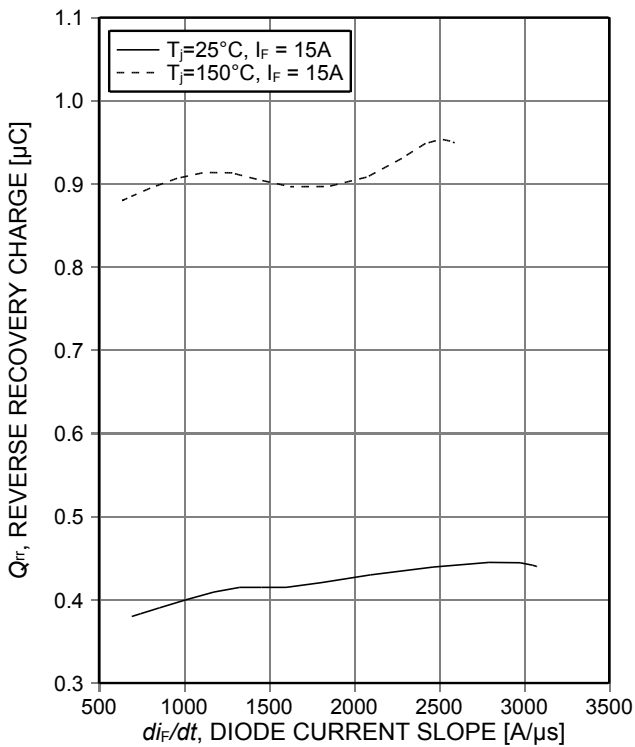

Figure 21. Typical reverse recovery charge as a function of diode current slope ($V_R=400V$)

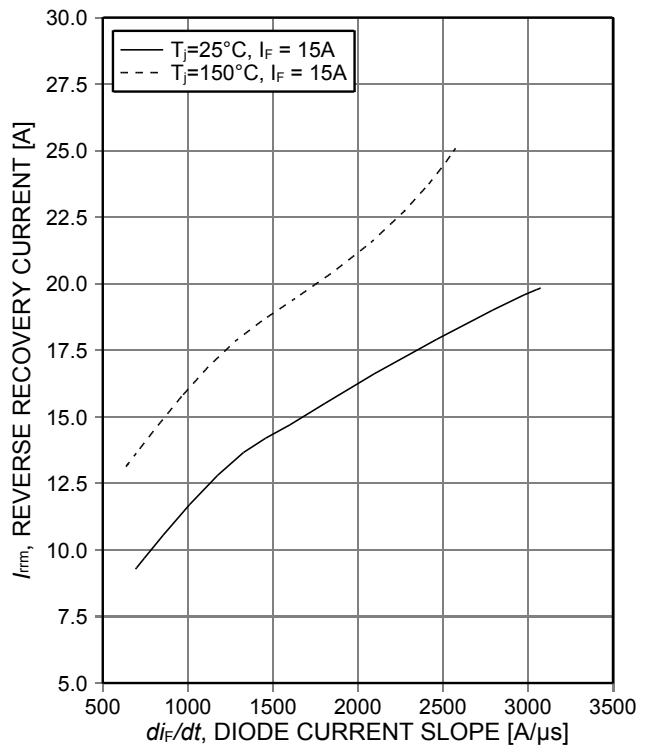

Figure 22. Typical peak reverse recovery current as a function of diode current slope ($V_R=400V$)

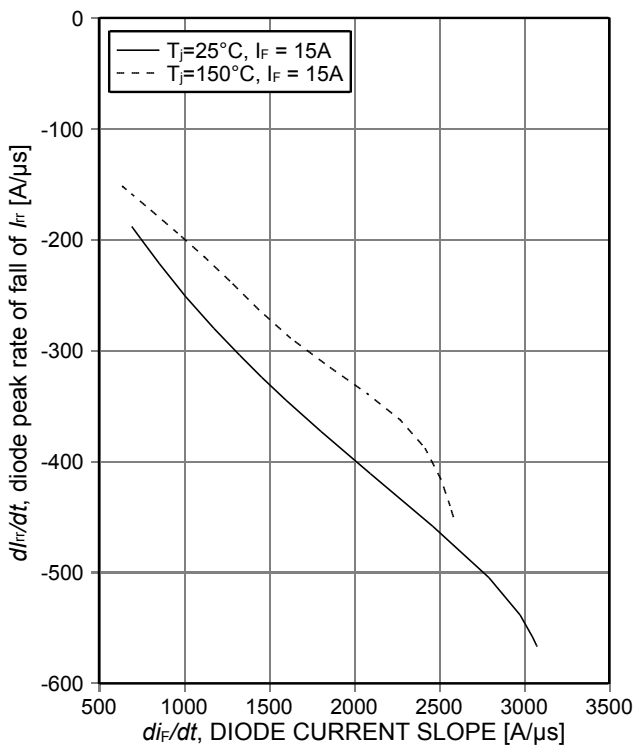

Figure 23. Typical diode peak rate of fall of reverse recovery current as a function of diode current slope ($V_R=400V$)

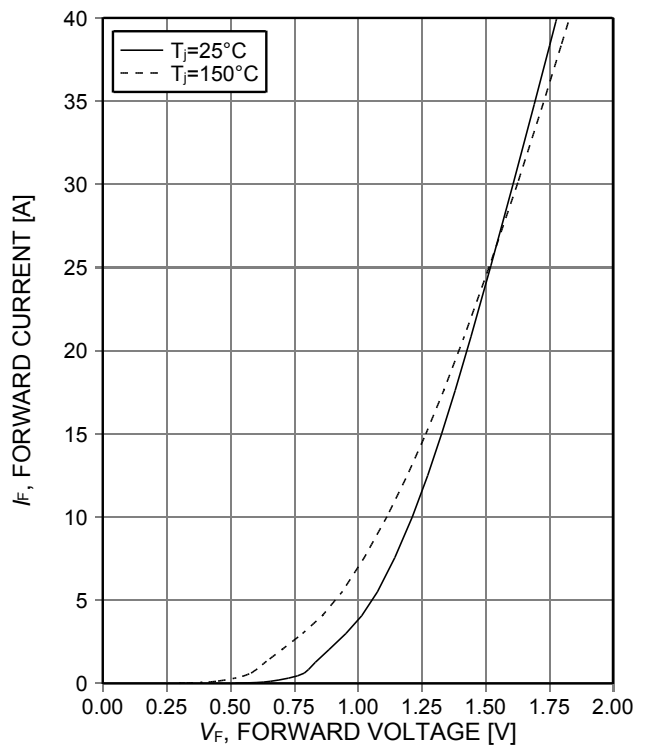

Figure 24. Typical diode forward current as a function of forward voltage

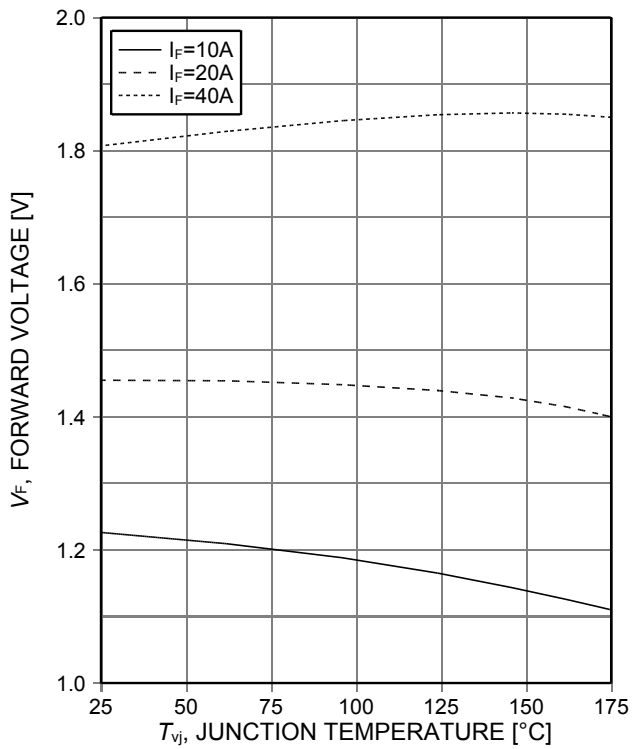
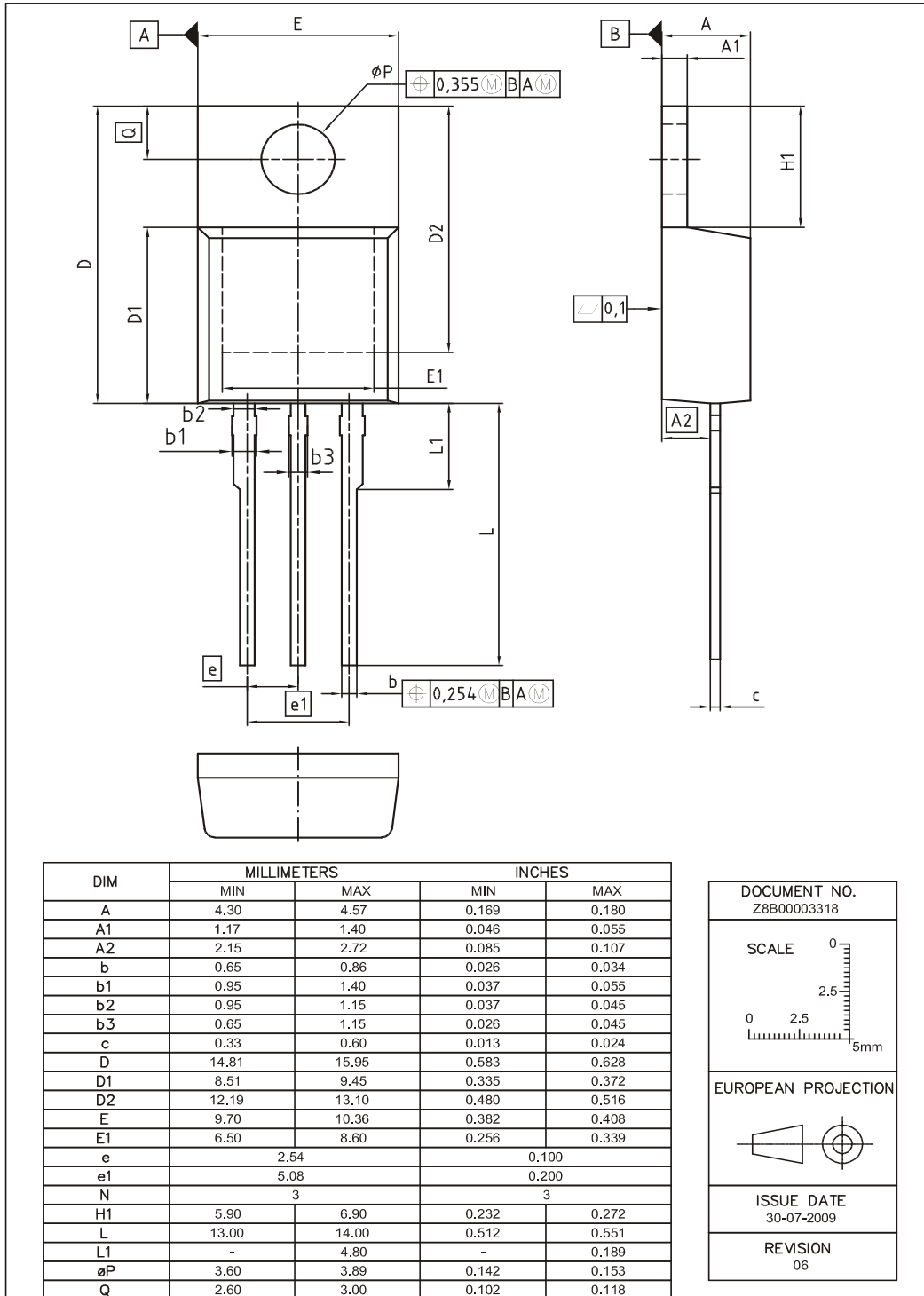

Figure 25. Typical diode forward voltage as a function of junction temperature

PG-TO220-3



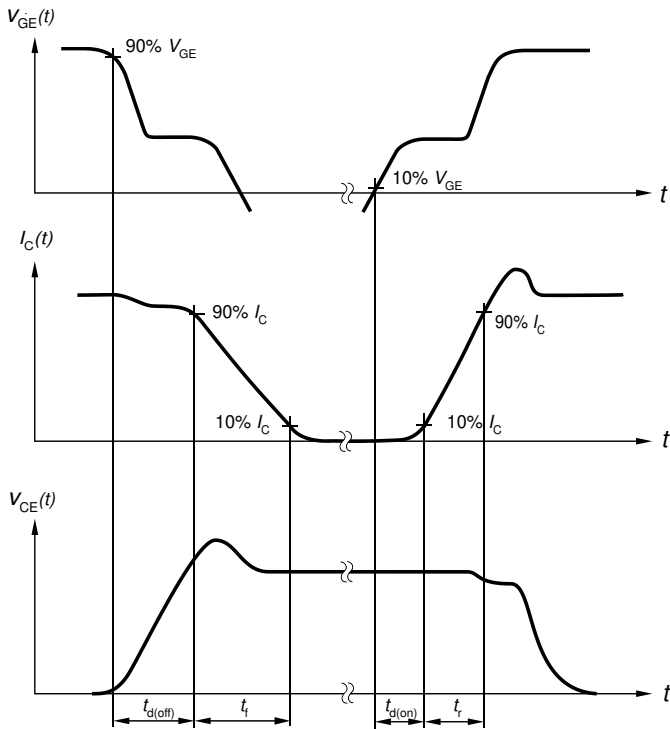

Figure A. Definition of switching times

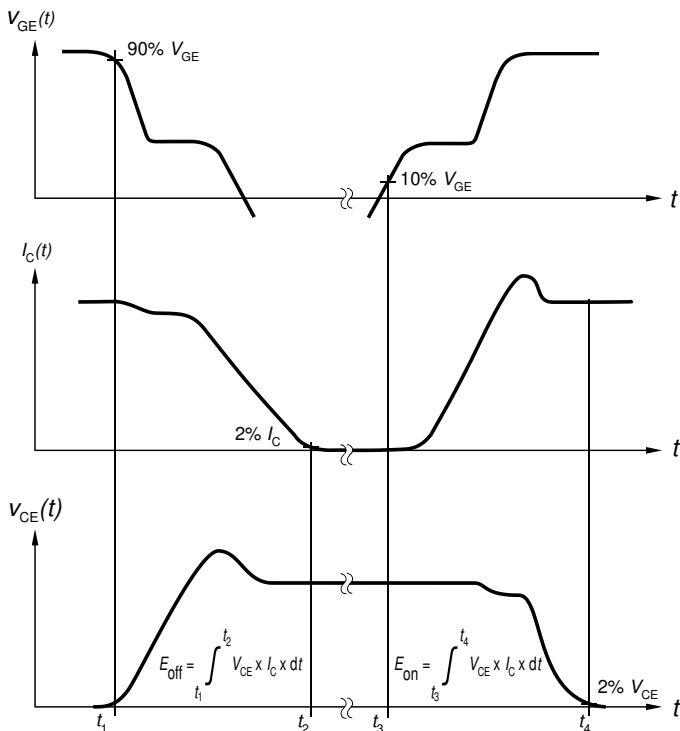

Figure B. Definition of switching losses

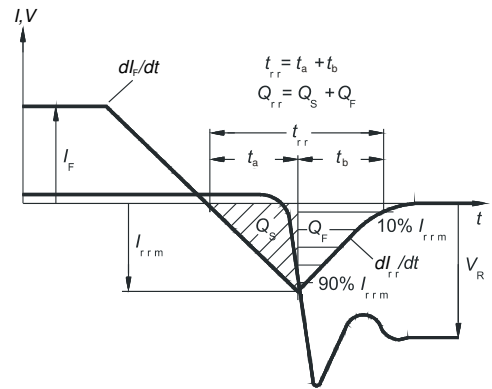

Figure C. Definition of diode switching characteristics

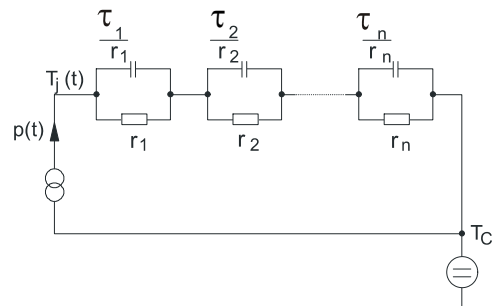

Figure D. Thermal equivalent circuit

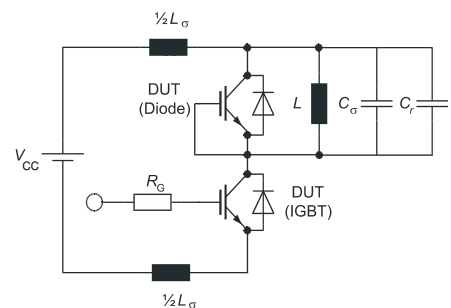

Figure E. Dynamic test circuit
 Parasitic inductance L_σ ,
 parasitic capacitor L_σ ,
 relief capacitor C_r ,
 (only for ZVT switching)

Revision History

IKP30N65F5

Revision: 2014-12-04, Rev. 2.2

Previous Revision

Revision	Date	Subjects (major changes since last revision)
2.1	2014-06-11	Final data sheet
2.2	2014-12-04	Minor changes Fig.1 and Fig.14

We Listen to Your Comments

Any information within this document that you feel is wrong, unclear or missing at all?

Your feedback will help us to continuously improve the quality of this document.

Please send your proposal (including a reference to this document) to: erratum@infineon.com

Published by

Infineon Technologies AG

81726 Munich, Germany

81726 München, Germany

© 2014 Infineon Technologies AG

All Rights Reserved.

Legal Disclaimer

The information given in this document shall in no event be regarded as a guarantee of conditions or characteristics.

With respect to any examples or hints given herein, any typical values stated herein and/or any information regarding the application of the device, Infineon Technologies hereby disclaims any and all warranties and liabilities of any kind, including without limitation, warranties of non-infringement of intellectual property rights of any third party.

Information

For further information on technology, delivery terms and conditions and prices, please contact the nearest Infineon Technologies Office (www.infineon.com).

Warnings

Due to technical requirements, components may contain dangerous substances. For information on the types in question, please contact the nearest Infineon Technologies Office.

The Infineon Technologies component described in this Data Sheet may be used in life-support devices or systems and/or automotive, aviation and aerospace applications or systems only with the express written approval of Infineon Technologies, if a failure of such components can reasonably be expected to cause the failure of that life-support, automotive, aviation and aerospace device or system or to affect the safety or effectiveness of that device or system. Life support devices or systems are intended to be implanted in the human body or to support and/or maintain and sustain and/or protect human life. If they fail, it is reasonable to assume that the health of the user or other persons may be endangered.