

**PLUG MATED TO R/A RECEPTACLE  
MATED PROFILE**

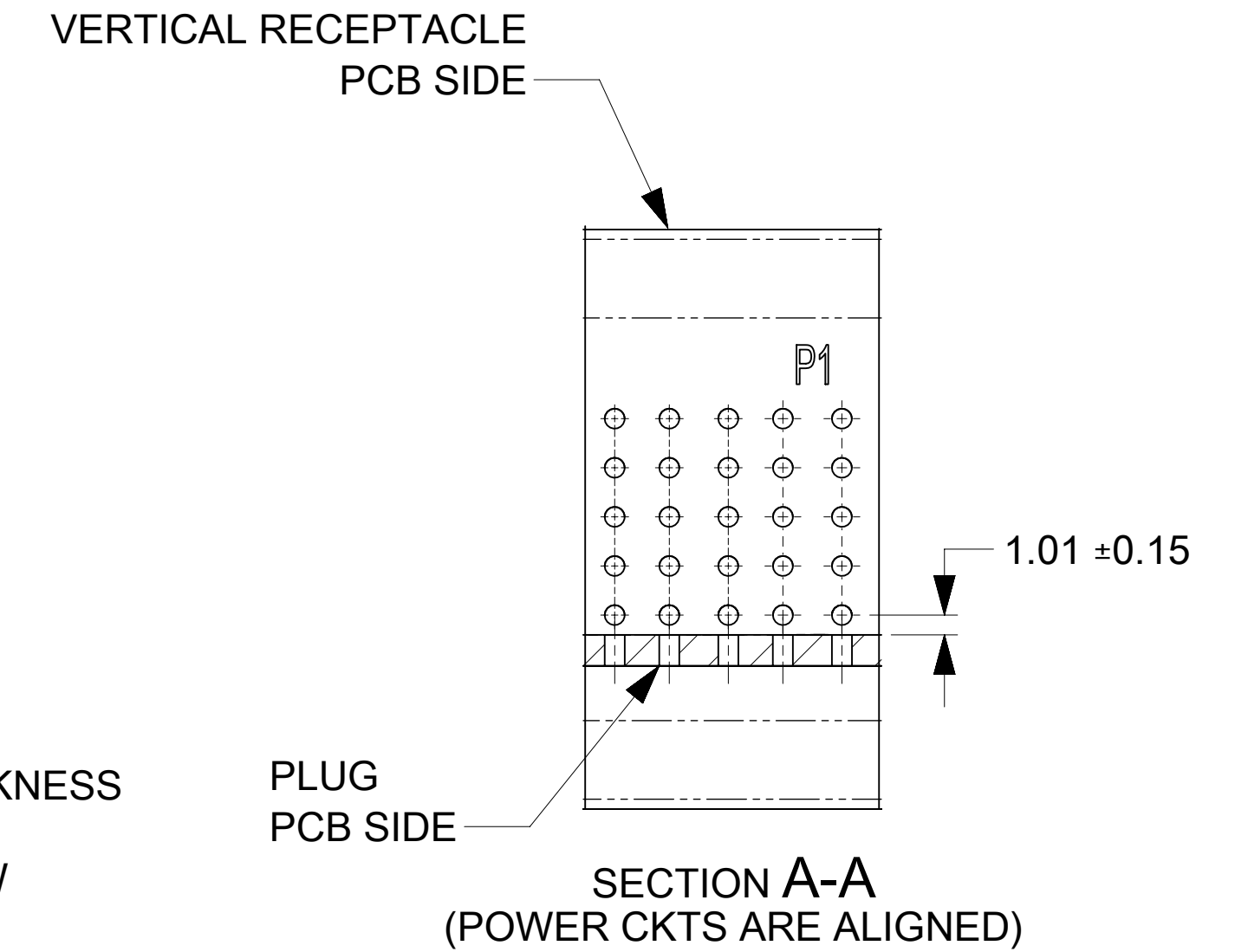

**PLUG MATED TO VERTICAL RECEPTACLE  
MATED PROFILE**

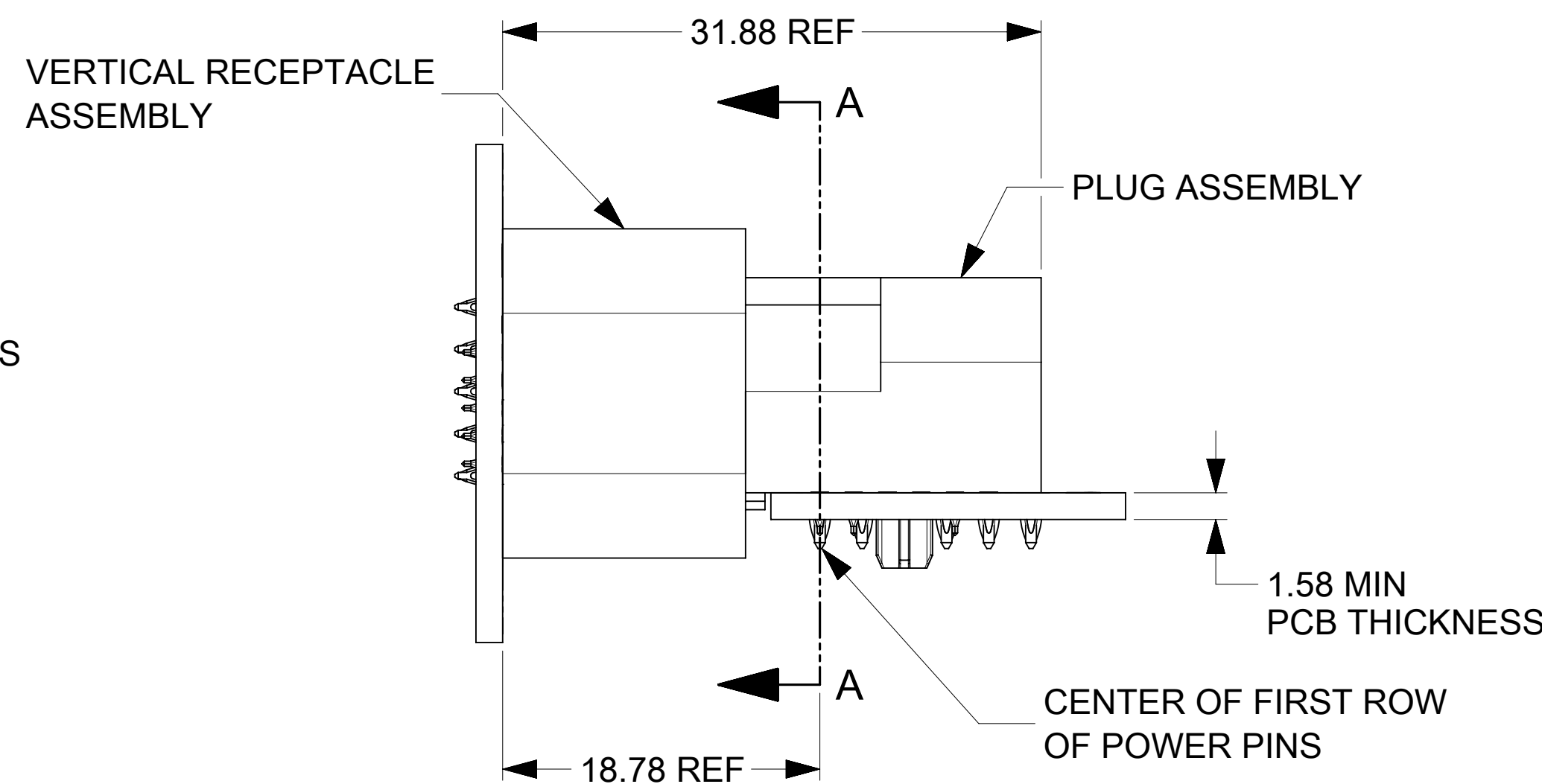
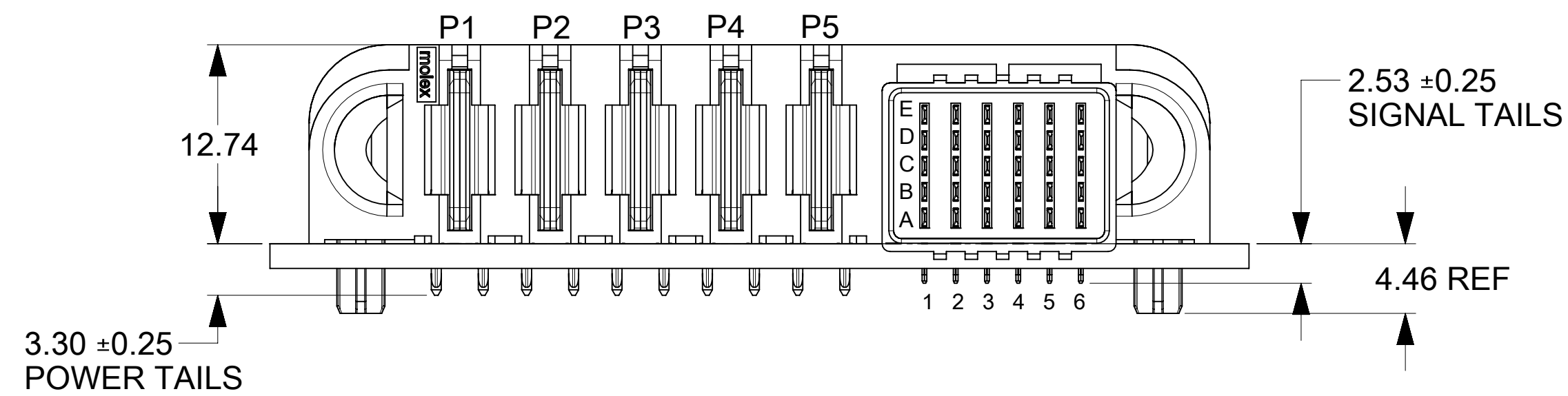
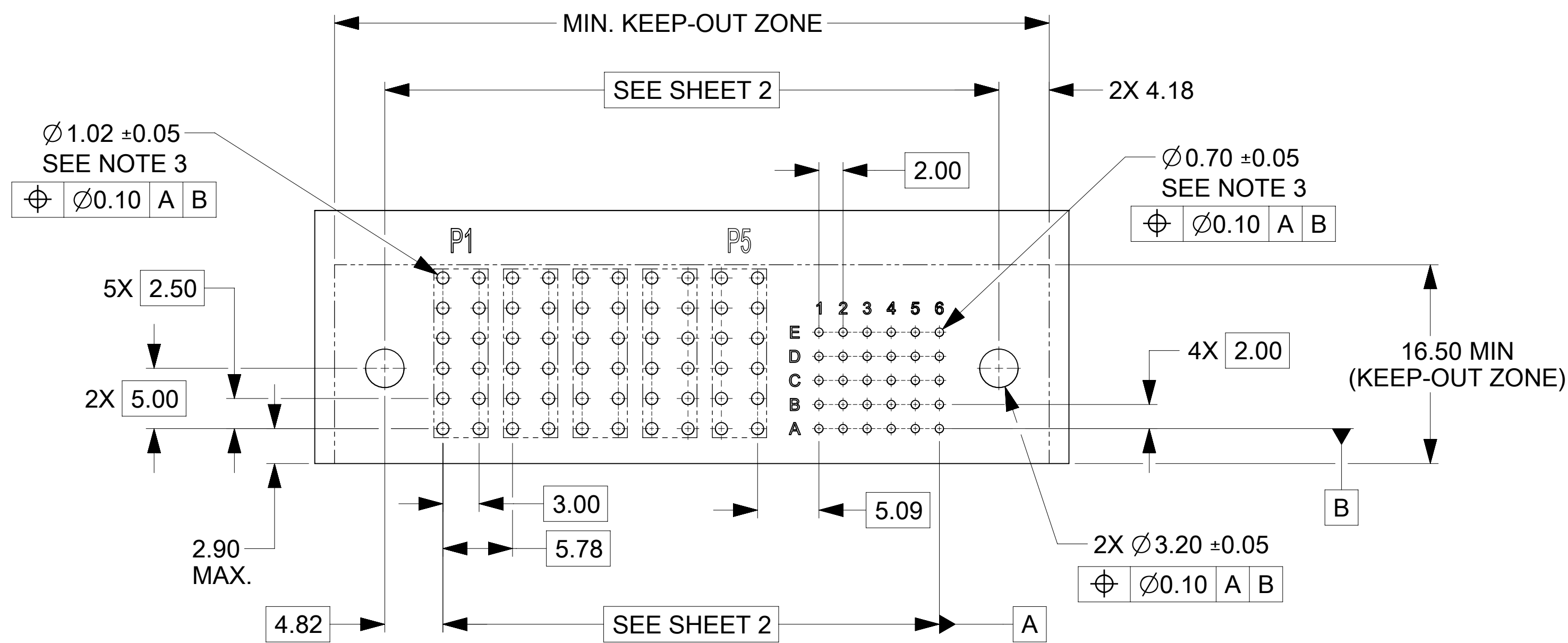

**NOTES:**

- MATERIAL:**  
 -HOUSINGS: LCP UL94, V-0, COLOR : BLACK  
 -TERMINALS: HIGH CONDUCTIVITY COPPER ALLOY  
 -PLATING: 1.27 µm (50 µin) NICKEL OVERALL WITH  
 2.54 µm (100 µin) SELECTIVE TIN ON TAILS AND  
 0.762 µm (30 µin) SELECTIVE GOLD ON CONTACT AREA
- PACKAGING:** ASSEMBLIES TO BE TRAY PACKED PER PACKAGING SPEC: 2141130010-PK.
- PLATED THRU HOLE SIZE,** REFER TO PRODUCT SPEC. FOR DETAILS.
- PRODUCT SPEC:** 2141130000-PS.
- PRODUCT TO MEET RoHS REQUIREMENTS.**
- PLUG ASSEMBLY MATES TO MOLEX RECEPTACLES** 219563XXXX-SD AND 219564XXXX-SD, SEE DRAWINGS FOR DETAILS.
- TAIL DESIGN:** COMPLIANT PIN.
- POWER TERMINALS AND SIGNALS ARE LUBRICATED.**
- APPLICATION SPECIFICATION:** 2141130000-AS (FOR COMPLIANT TAILS ONLY).

THIS DRAWING CONTAINS INFORMATION THAT IS PROPRIETARY TO MOLEX ELECTRONIC TECHNOLOGIES, LLC AND SHOULD NOT BE USED WITHOUT WRITTEN PERMISSION									
DIMENSION UNITS	SCALE	CURRENT REV DESC:							
mm	3:1								
GENERAL TOLERANCES (UNLESS SPECIFIED)									
ANGULAR TOL	± °								
4 PLACES	±								
3 PLACES	±								
2 PLACES	± 0.25								
1 PLACE	± 0.3								
0 PLACES	±								
DRAFT WHERE APPLICABLE MUST REMAIN WITHIN DIMENSIONS		THIRD ANGLE PROJECTION	DRAWING	SERIES					
			D-SIZE	219562					
					MATERIAL NUMBER	CUSTOMER	SHEET NUMBER		
					SEE CHART		1 OF 2		

**RECOMMENDED PCB LAYOUT AND KEEP-OUT ZONE**



GUARDIAN HD RA PLUG RIGHT SIGNAL WITH POWER PF

PRODUCT CUSTOMER DRAWING

DOCUMENT NUMBER	DOC TYPE	DOC PART	REVISION
2195629001-SD	PSD	000	A1

PART NUMBER	CONFIGURATION	QUANTITY PER CARTON (DU)
219562-0011	G+1P+15S+G	135

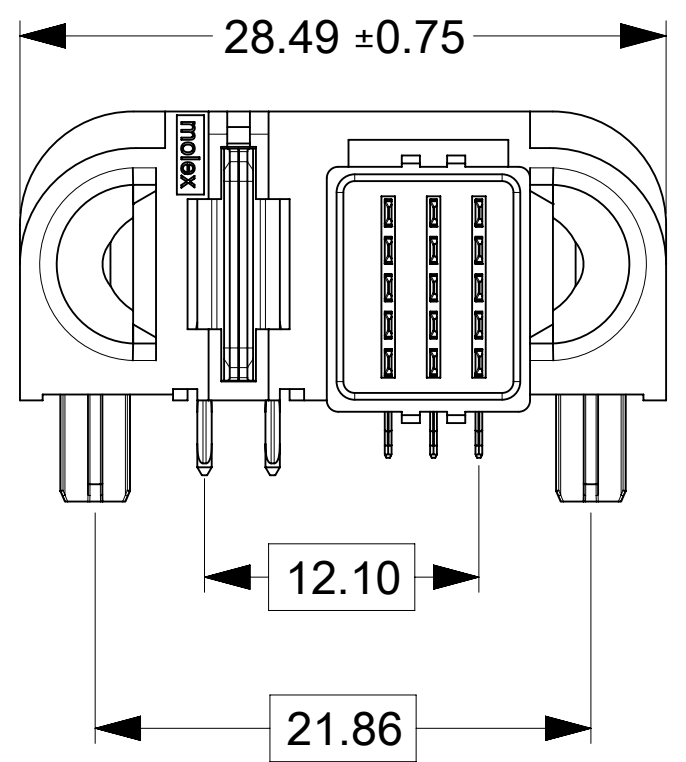

PART NUMBER	CONFIGURATION	QUANTITY PER CARTON (DU)
219562-0012	G+2P+15S+G	105

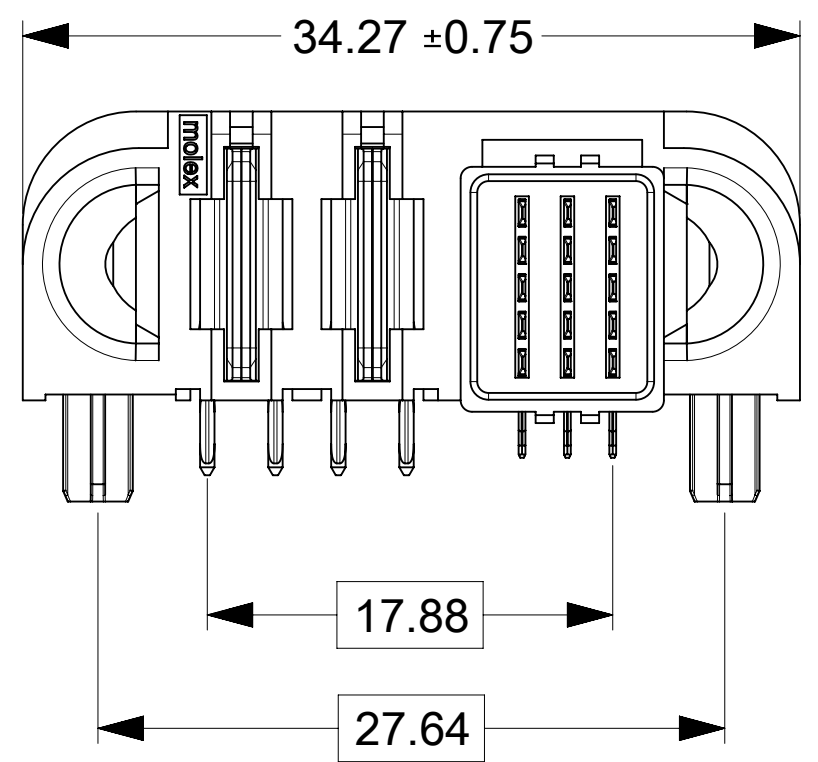

PART NUMBER	CONFIGURATION	QUANTITY PER CARTON (DU)
219562-0013	G+3P+15S+G	90

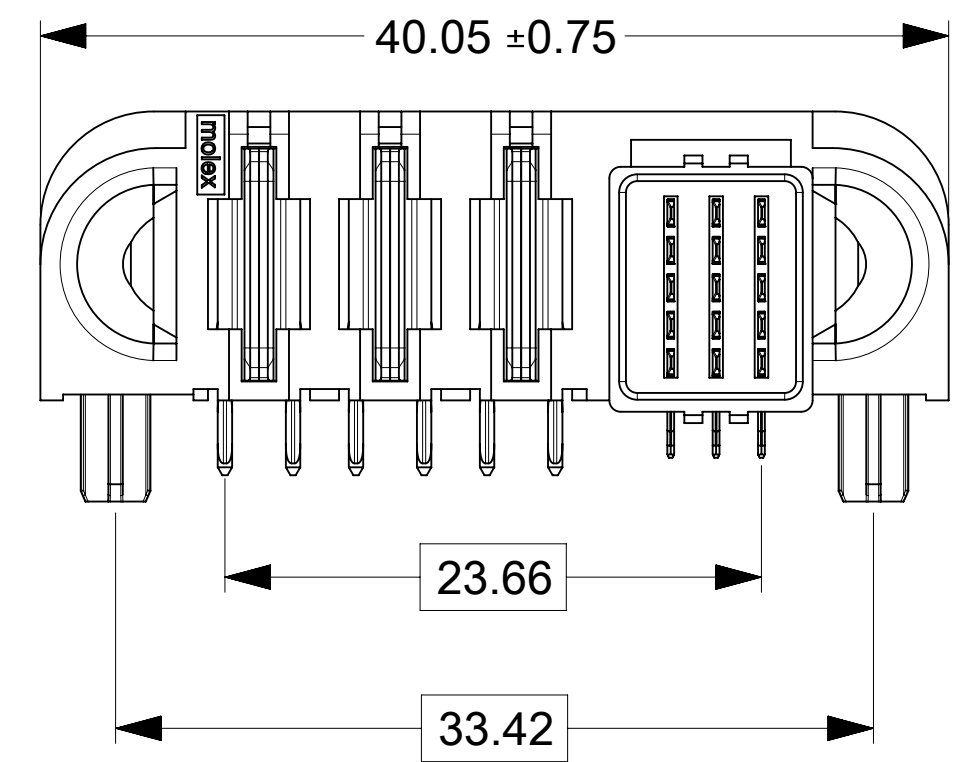

PART NUMBER	CONFIGURATION	QUANTITY PER CARTON (DU)
219562-0014	G+4P+15S+G	75

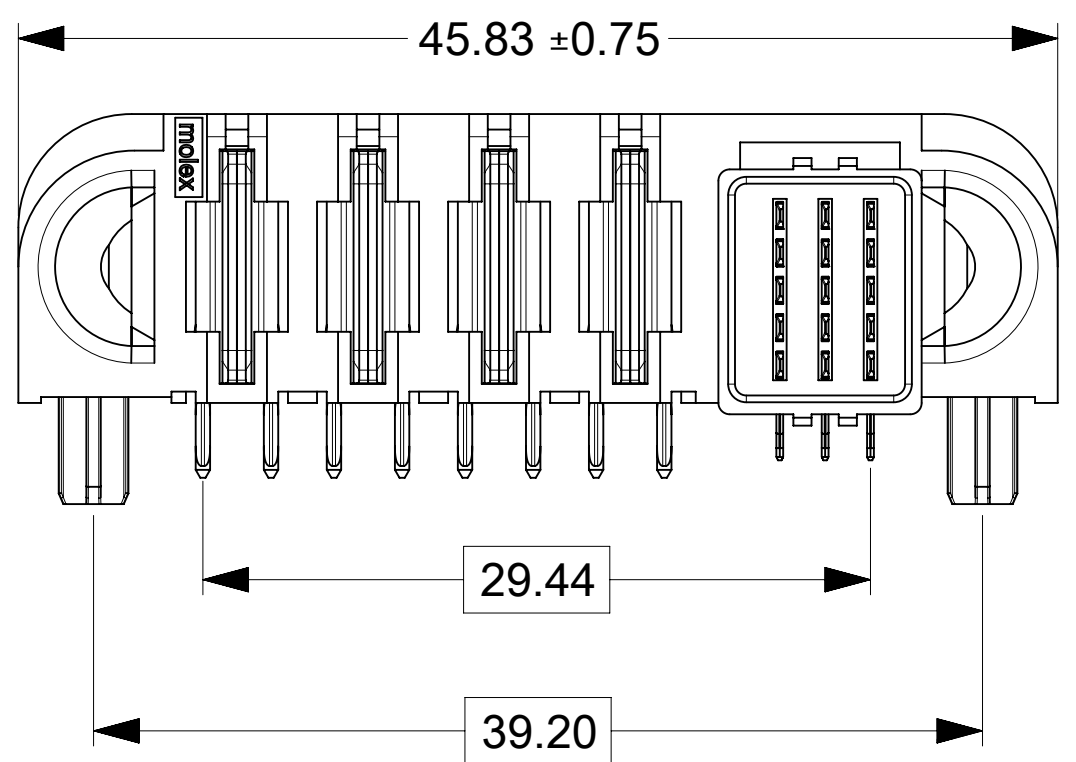

PART NUMBER	CONFIGURATION	QUANTITY PER CARTON (DU)
219562-0015	G+5P+15S+G	75

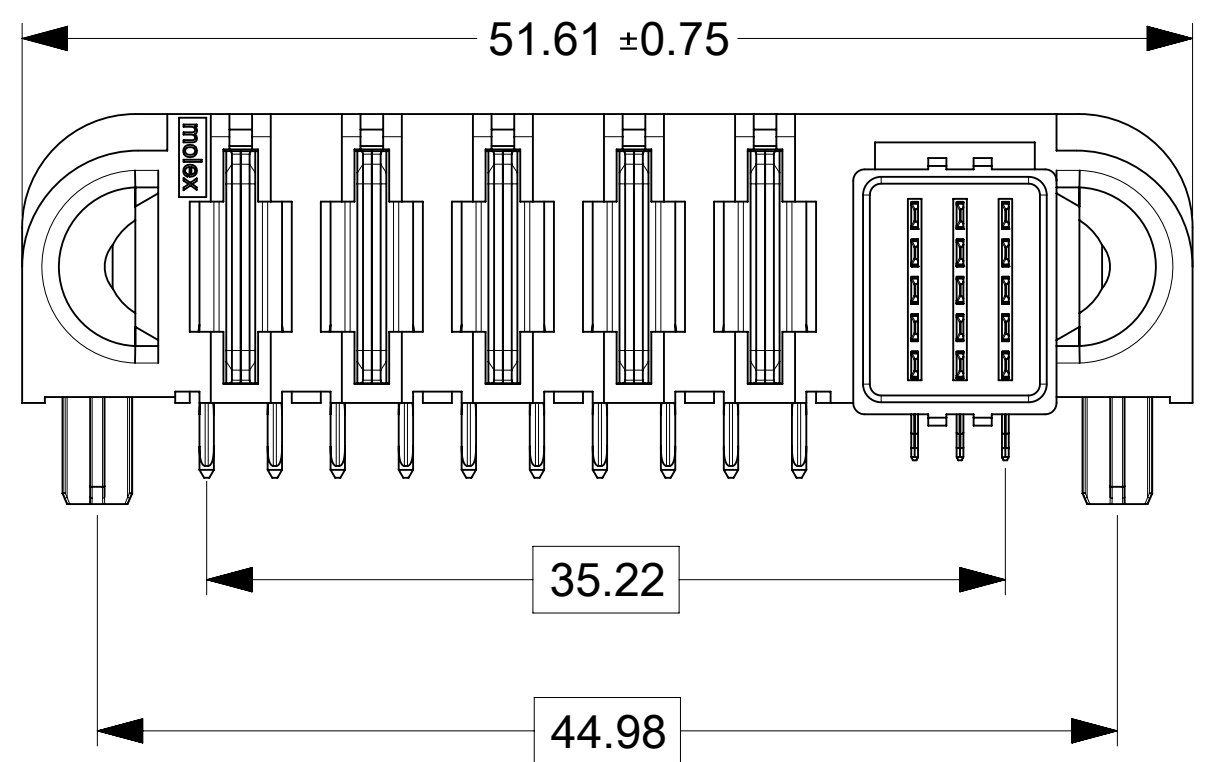

PART NUMBER	CONFIGURATION	QUANTITY PER CARTON (DU)
219562-0016	G+1P+30S+G	105

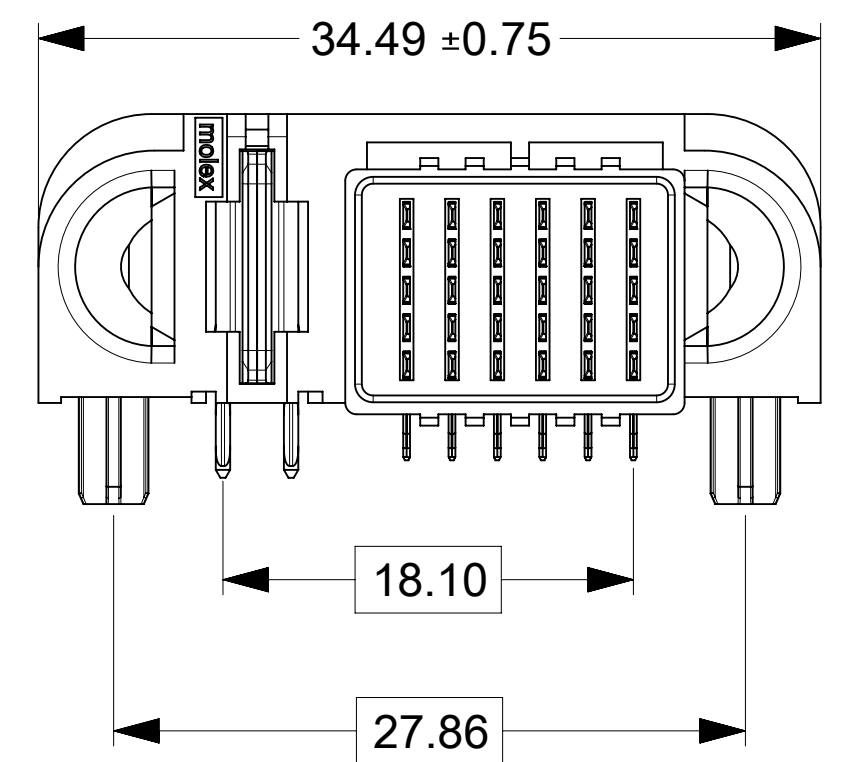

PART NUMBER	CONFIGURATION	QUANTITY PER CARTON (DU)
219562-0017	G+2P+30S+G	90

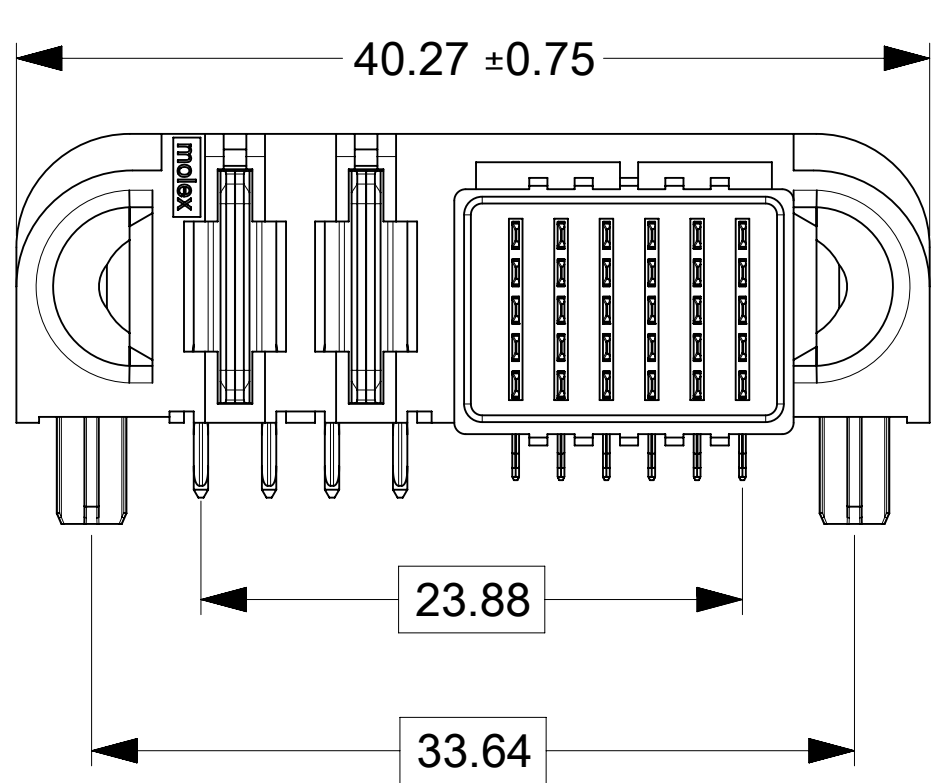

PART NUMBER	CONFIGURATION	QUANTITY PER CARTON (DU)
219562-0018	G+3P+30S+G	75

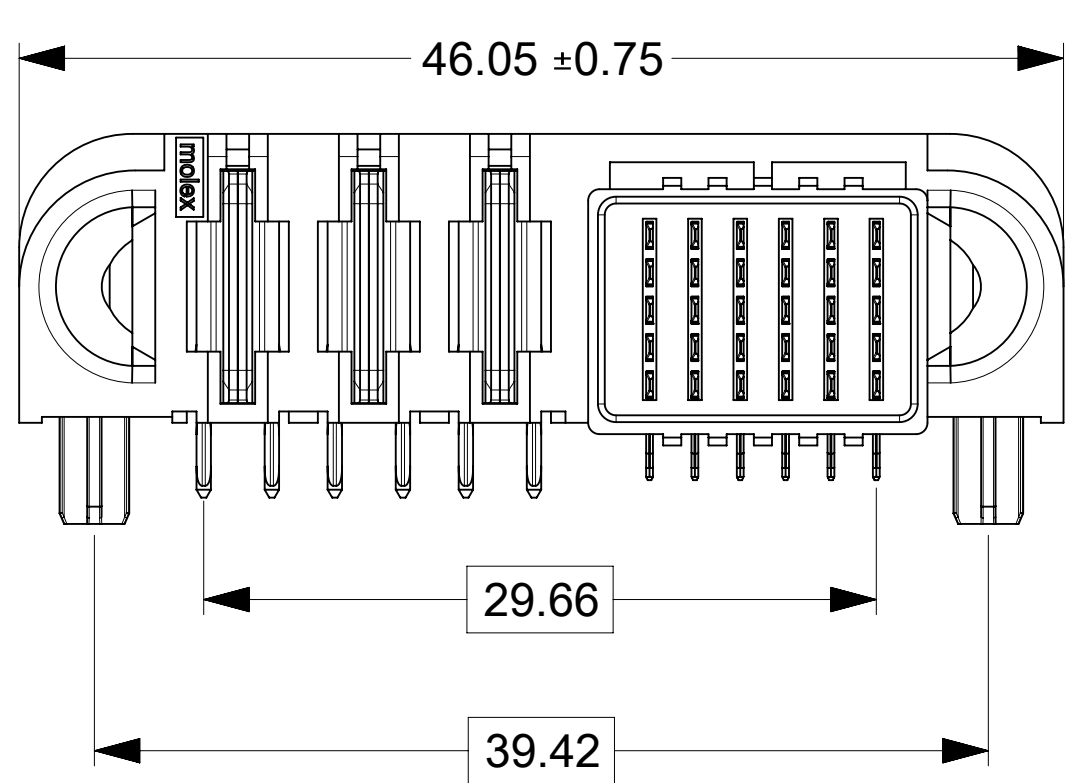

PART NUMBER	CONFIGURATION	QUANTITY PER CARTON (DU)
219562-0019	G+4P+30S+G	75

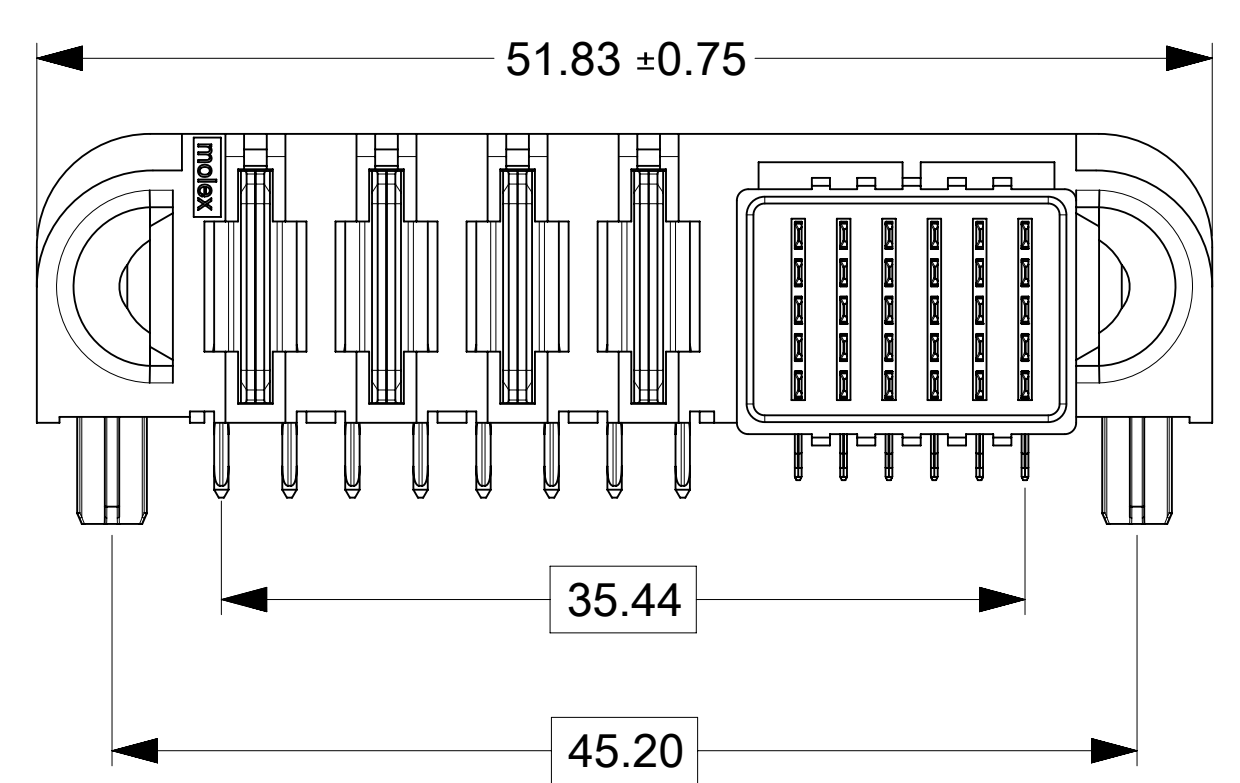

PART NUMBER	CONFIGURATION	QUANTITY PER CARTON (DU)
219562-0020	G+5P+30S+G	60

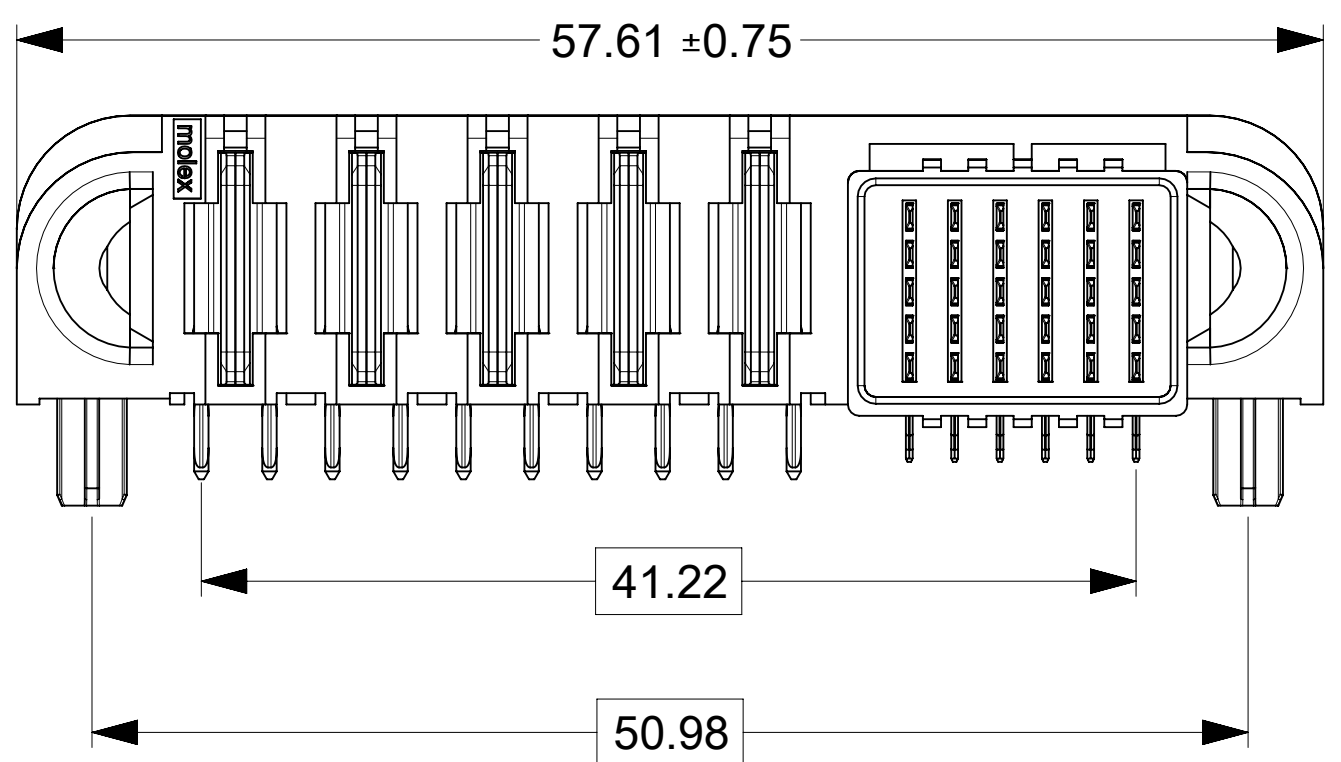

THIS DRAWING CONTAINS INFORMATION THAT IS PROPRIETARY TO MOLEX ELECTRONIC TECHNOLOGIES, LLC AND SHOULD NOT BE USED WITHOUT WRITTEN PERMISSION

DIMENSION UNITS	SCALE	CURRENT REV DESC:	
mm	3:1		
GENERAL TOLERANCES (UNLESS SPECIFIED)			
ANGULAR TOL	±	°	
4 PLACES	±		
3 PLACES	±		
2 PLACES	±	0.25	
1 PLACE	±	0.3	
0 PLACES	±		
DRAFT WHERE APPLICABLE MUST REMAIN WITHIN DIMENSIONS		THIRD ANGLE PROJECTION	DRAWING SERIES
			D-SIZE 219562

EC NO: 745288		2023/03/09	
DRWN: LZABJANOVSKI		2023/04/10	
CHK'D: JAYK1		2023/04/10	
APPR: JAYK1		2023/04/10	
INITIAL REVISION:			
DRWN: LZABJANOVSKI		2022/03/14	
APPR: BPISZCZOR		2022/08/04	

DOCUMENT NUMBER		DOC TYPE	DOC PART	REVISION
2195629001-SD		PSD	000	A1
MATERIAL NUMBER		CUSTOMER		SHEET NUMBER
SEE CHART				2 OF 2

**molex**

GUARDIAN HD RA PLUG RIGHT SIGNAL WITH POWER PF

PRODUCT CUSTOMER DRAWING

DOCUMENT STATUS	P1	RELEASE DATE	2023/04/11	17:04:40
-----------------	----	--------------	------------	----------