

# Q1PACK Module

## NXH50M65L4Q1SG, NXH50M65L4Q1PTG

This high-density, integrated power module combines high-performance IGBTs with rugged anti-parallel diodes.

### Features

- Extremely Efficient Trench with Fieldstop Technology
- Low Switching Loss Reduces System Power Dissipation
- Module Design Offers High Power Density
- Low Inductive Layout
- Q1PACK Packages with Solder and Pressfit Pins

### Typical Applications

- Solar Inverters
- Uninterruptable Power Supplies

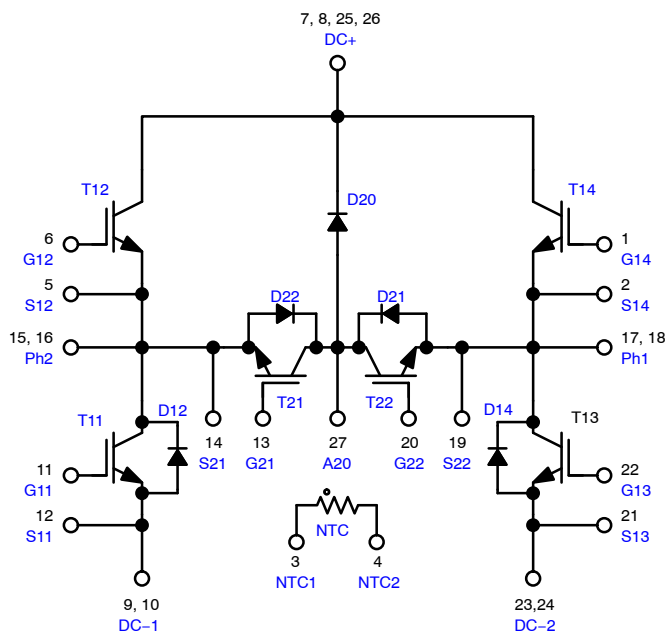


Figure 1. Schematic

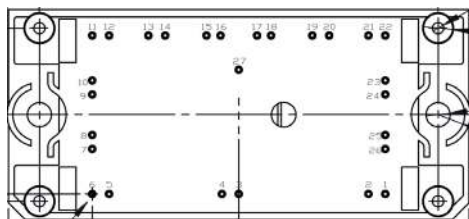
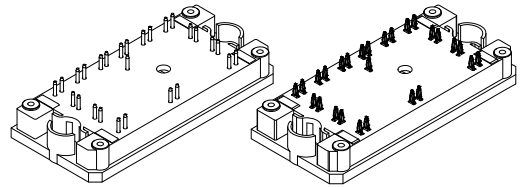


Figure 2. Pin Assignments

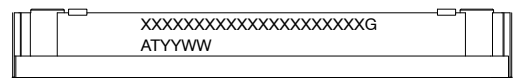
50 A, 650 V Module



PIM27, 71x37.4  
(SOLDER PIN)  
CASE 180CA

PIM27, 71x37.4  
(PRESSFIT PIN)  
CASE 180CP

### MARKING DIAGRAM



XXXXXX = Specific Device Code  
G = Pb-Free Package  
AT = Assembly & Test Site Code  
YYWW = Year and Work Week Code

### ORDERING INFORMATION

See detailed ordering and shipping information on page 9 of this data sheet.

# NXH50M65L4Q1SG, NXH50M65L4Q1PTG

## ABSOLUTE MAXIMUM RATINGS

Rating	Symbol	Value	Unit
<b>IGBT (T11, T12, T13, T14, T21, T22)</b>			
Collector-emitter voltage	$V_{CES}$	650	V
Collector current @ $T_h = 80^\circ\text{C}$ (per IGBT)	$I_C$	48	A
Pulsed collector current, $T_{\text{pulse}}$ limited by $T_{j\text{max}}$	$I_{CM}$	144	A
Power Dissipation Per IGBT $T_j = T_{j\text{max}}, T_h = 80^\circ\text{C}$	$P_{\text{tot}}$	72	W
Gate-emitter voltage	$V_{GE}$	$\pm 20$	V
Maximum Junction Temperature	$T_J$	175	$^\circ\text{C}$

## DIODE (D12, D14, D20, D21, D22)

Peak Repetitive Reverse Voltage	$V_{RRM}$	650	V
Forward Current, DC @ $T_h = 80^\circ\text{C}$ (per Diode)	$I_F$	50	A
Nonrepetitive Peak Surge Current (Surge applied at rated load conditions halfwave, single phase, 60 Hz)	$I_{FSM}$	225	A
Power Dissipation Per Diode $T_j = T_{j\text{max}}, T_h = 80^\circ\text{C}$	$P_{\text{tot}}$	86	W
Maximum Junction Temperature	$T_J$	175	$^\circ\text{C}$

## THERMAL PROPERTIES

Operating Temperature under switching condition	$T_{VJ\text{OP}}$	-40 to ( $T_{j\text{max}} - 25$ )	$^\circ\text{C}$
Storage Temperature range	$T_{\text{stg}}$	-40 to 125	$^\circ\text{C}$

## INSULATION PROPERTIES

Isolation test voltage, $t = 2$ min, 60 Hz	$V_{\text{is}}$	4000	Vac
Creepage distance		12.7	mm

Stresses exceeding those listed in the Maximum Ratings table may damage the device. If any of these limits are exceeded, device functionality should not be assumed, damage may occur and reliability may be affected.

## ELECTRICAL CHARACTERISTICS ( $T_J = 25^\circ\text{C}$ unless otherwise specified)

Parameter	Test Condition	Symbol	Min	Typ	Max	Unit
<b>IGBT (T11, T12, T13, T14, T21, T22)</b>						
Collector-emitter cutoff current	$V_{GE} = 0\text{ V}, V_{CE} = 650\text{ V}$	$I_{CES}$	-	-	300	$\mu\text{A}$
Collector-emitter saturation voltage	$V_{GE} = 15\text{ V}, I_C = 50\text{ A}, T_j = 25^\circ\text{C}$ $V_{GE} = 15\text{ V}, I_C = 50\text{ A}, T_j = 150^\circ\text{C}$	$V_{CE(\text{sat})}$	-	1.56 1.76	2.22 -	V
Gate-emitter threshold voltage	$V_{GE} = V_{CE}, I_C = 50\text{ mA}$	$V_{GE(\text{TH})}$	3.1	4.45	5.2	V
Gate leakage current	$V_{GE} = 20\text{ V}, V_{CE} = 0\text{ V}$	$I_{GES}$	-	-	400	nA
Turn-on delay time	$T_j = 25^\circ\text{C}$ $V_{CE} = 350\text{ V}, I_C = 50\text{ A}$ $V_{GE} = 15\text{ V}, -9\text{ V}, R_G = 6\ \Omega$	$t_{d(\text{on})}$	-	14	-	ns
Rise time		$t_r$	-	20	-	
Turn-off delay time		$t_{d(\text{off})}$	-	68	-	
Fall time		$t_f$	-	20	-	
Turn on switching loss		$E_{\text{on}}$	-	0.46	-	mJ
Turn off switching loss		$E_{\text{off}}$	-	0.44	-	
Turn-on delay time	$T_j = 125^\circ\text{C}$ $V_{CE} = 350\text{ V}, I_C = 50\text{ A}$ $V_{GE} = 15\text{ V}, -9\text{ V}, R_G = 6\ \Omega$	$t_{d(\text{on})}$	-	16	-	ns
Rise time		$t_r$	-	23	-	
Turn-off delay time		$t_{d(\text{off})}$	-	78	-	
Fall time		$t_f$	-	52	-	
Turn on switching loss		$E_{\text{on}}$	-	0.78	-	mJ
Turn off switching loss		$E_{\text{off}}$	-	0.60	-	

# NXH50M65L4Q1SG, NXH50M65L4Q1PTG

## ELECTRICAL CHARACTERISTICS (T<sub>J</sub> = 25°C unless otherwise specified) (continued)

Parameter	Test Condition	Symbol	Min	Typ	Max	Unit
<b>IGBT (T11, T12, T13, T14, T21, T22)</b>						
Input capacitance	V <sub>CE</sub> = 20 V, V <sub>GE</sub> = 0 V, f = 1 MHz	C <sub>ies</sub>	–	3137	–	pF
Output capacitance		C <sub>oes</sub>	–	146	–	
Reverse transfer capacitance		C <sub>res</sub>	–	17	–	
Gate charge total	V <sub>CE</sub> = 350 V, I <sub>C</sub> = 40 A, V <sub>GE</sub> = ±15 V	Q <sub>g</sub>	–	180	–	nC
Thermal Resistance – chip-to-heatsink	Thermal grease, Thickness = 2.1 Mil ±2% λ = 2.9 W/mK	R <sub>thJH</sub>	–	1.32	–	°C/W
Thermal Resistance – chip-to-case		R <sub>thJC</sub>	–	0.96	–	°C/W

## IGBT INVERSE DIODE (D12, D14, D21, D22)

Forward voltage	I <sub>F</sub> = 50 A, T <sub>J</sub> = 25°C I <sub>F</sub> = 50 A, T <sub>J</sub> = 175°C	V <sub>F</sub>	– –	2.25 1.7	2.7 –	V
Reverse Recovery Time	T <sub>J</sub> = 25°C V <sub>CE</sub> = 350 V, I <sub>C</sub> = 50 A V <sub>GE</sub> = 15 V, –9 V, R <sub>G</sub> = 6 Ω	t <sub>rr</sub>	–	28	–	ns
Reverse Recovery Current		Q <sub>rr</sub>	–	281	–	nc
Peak Reverse Recovery Current		I <sub>rrm</sub>	–	18	–	A
Peak Rate of Fall of Recovery Current		Di/dt <sub>max</sub>	–	1.42	–	A/μs
Reverse Recovery Energy		E <sub>rr</sub>	–	33	–	μJ
Reverse Recovery Time	T <sub>J</sub> = 125°C V <sub>CE</sub> = 350 V, I <sub>C</sub> = 50 A V <sub>GE</sub> = 15 V, –9 V, R <sub>G</sub> = 6 Ω	t <sub>rr</sub>	–	65	–	ns
Reverse Recovery Current		Q <sub>rr</sub>	–	1094	–	nc
Peak Reverse Recovery Current		I <sub>rrm</sub>	–	33	–	A
Peak Rate of Fall of Recovery Current		Di/dt <sub>max</sub>	–	1.32	–	A/μs
Reverse Recovery Energy		E <sub>rr</sub>	–	198	–	μJ
Thermal Resistance – chip-to-heatsink	Thermal grease, Thickness = 2.1 Mil ±2% λ = 2.9 W/mK	R <sub>thJH</sub>	–	1.10	–	°C/W
Thermal Resistance – chip-to-case		R <sub>thJC</sub>	–	0.79	–	°C/W

## DIODE (D20)

Forward voltage	I <sub>F</sub> = 50 A, T <sub>J</sub> = 25°C I <sub>F</sub> = 50 A, T <sub>J</sub> = 175°C	V <sub>F</sub>	– –	2.25 1.7	2.7 –	V
Reverse leakage current	V <sub>CE</sub> = 650 V, V <sub>GE</sub> = 0 V	I <sub>r</sub>	–	–	300	μA
Thermal Resistance – chip-to-heatsink	Thermal grease, Thickness = 2.1 Mil ±2% λ = 2.9 W/mK	R <sub>thJH</sub>	–	1.10	–	°C/W
Thermal Resistance – chip-to-case		R <sub>thJC</sub>	–	0.79	–	°C/W

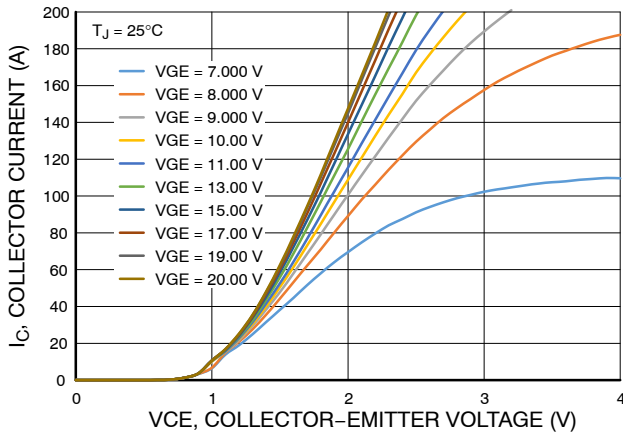
## THERMISTOR CHARACTERISTICS

Nominal resistance	T = 25°C	R <sub>25</sub>	–	22	–	kΩ
Nominal resistance	T = 100°C	R <sub>100</sub>	–	1486	–	Ω
Deviation of R25		R/R	–5	–	5	%
Power dissipation		P <sub>D</sub>	–	200	–	mW
Power dissipation constant			–	2	–	mW/°C
B-value	B (25/50), tol ±3%		–	–	3950	°C
B-value	B (25/100), tol ±3%		–	–	3998	°C
NTC reference			–	–	B	

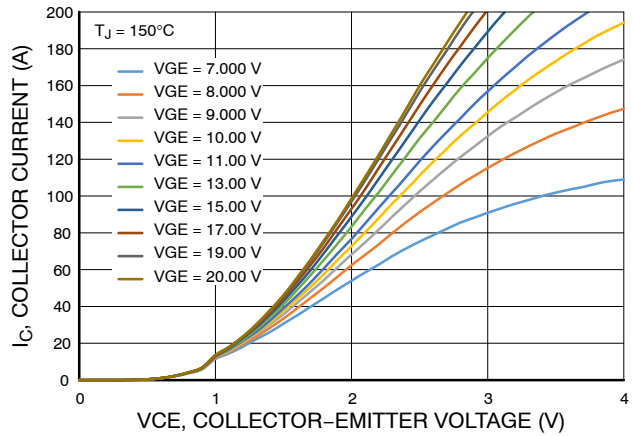
Product parametric performance is indicated in the Electrical Characteristics for the listed test conditions, unless otherwise noted. Product performance may not be indicated by the Electrical Characteristics if operated under different conditions.

# NXH50M65L4Q1SG, NXH50M65L4Q1PTG

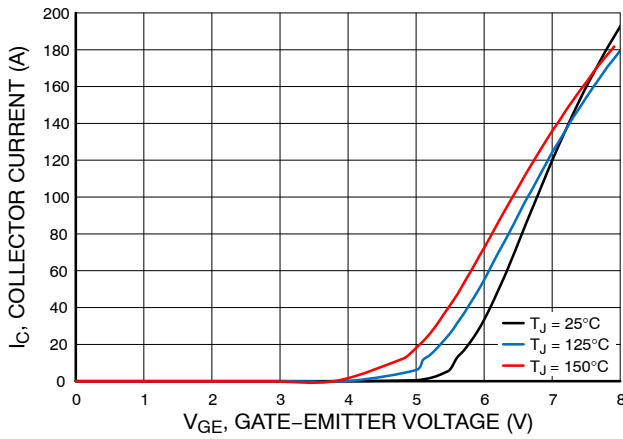
## TYPICAL CHARACTERISTICS – IGBT (T11, T12, T13, T14, T21, T22)



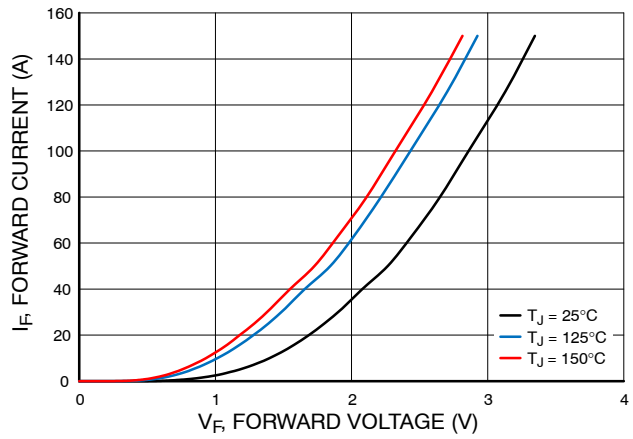
**Figure 3. Typical Output Characteristics**



**Figure 4. Typical Output Characteristics**

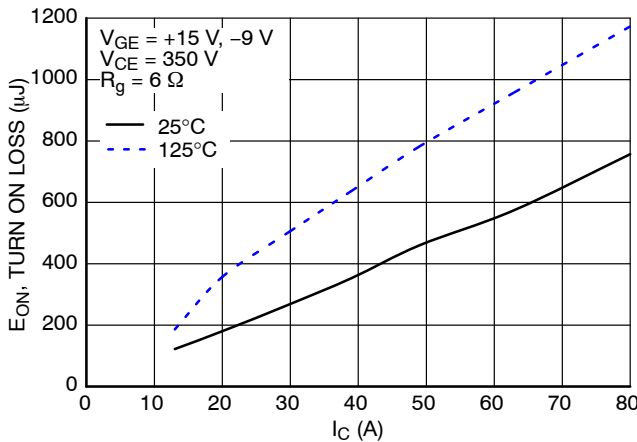


**Figure 5. Typical Transfer Characteristics**

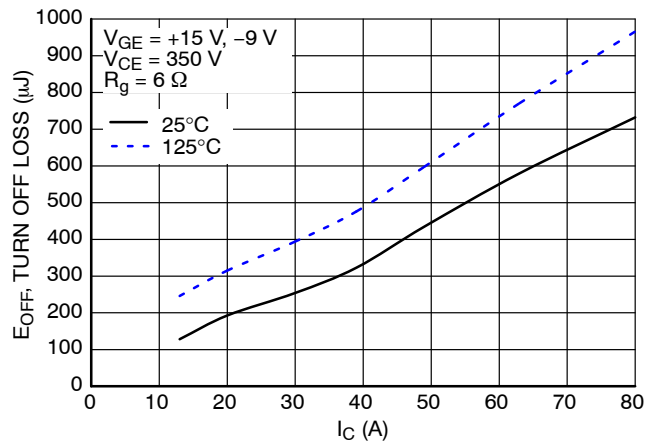


**Figure 6. Diode Forward Characteristics**

## TYPICAL CHARACTERISTICS – (T11, T12, T13, T14) IGBT COMMUTATES D21, D22 DIODE



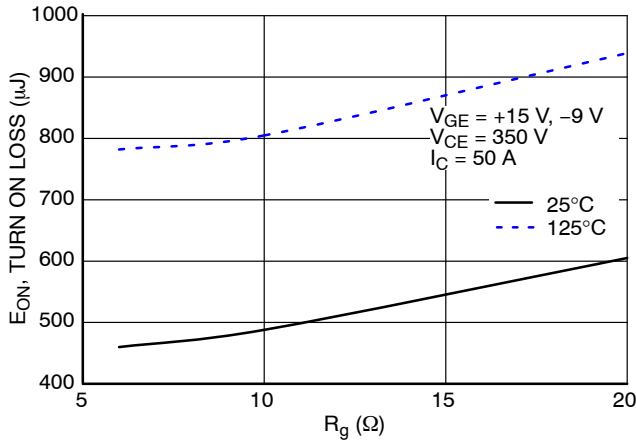
**Figure 7. Typical Turn ON Loss vs. IC**



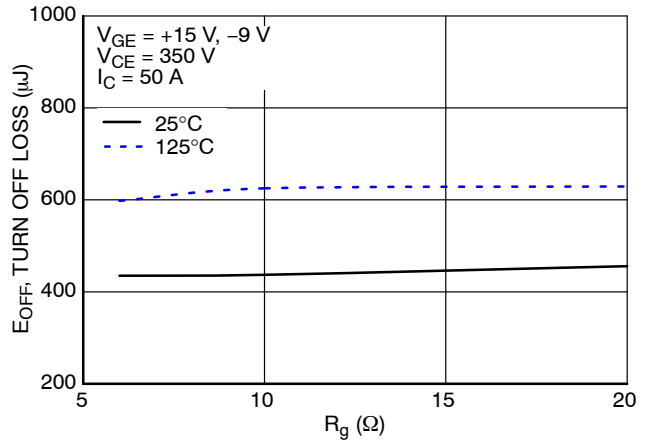
**Figure 8. Typical Turn OFF Loss vs. IC**

# NXH50M65L4Q1SG, NXH50M65L4Q1PTG

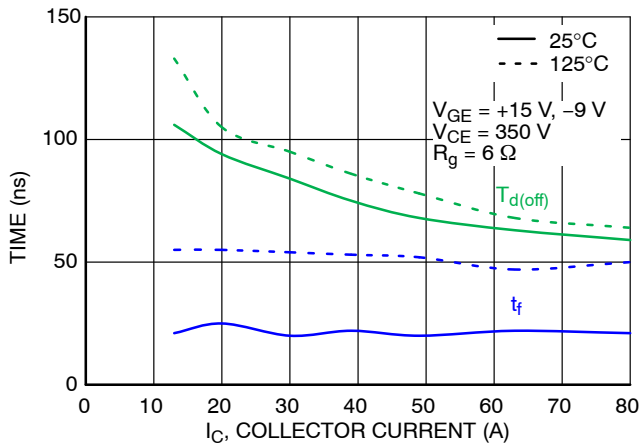
## TYPICAL CHARACTERISTICS – (T11, T12, T13, T14) IGBT COMMUTATES D21, D22 DIODE (CONTINUED)



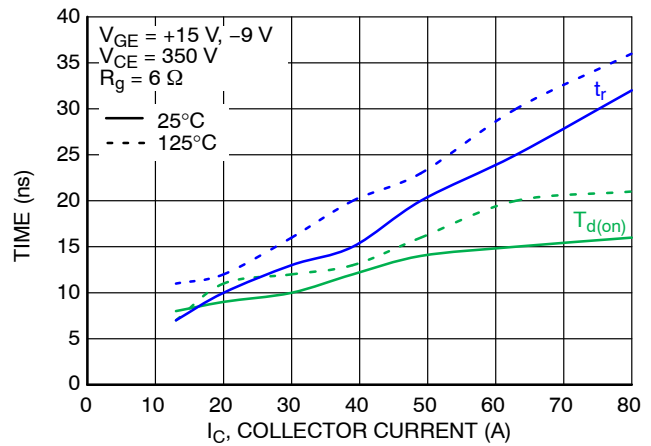
**Figure 9. Typical Turn ON Loss vs. Rg**



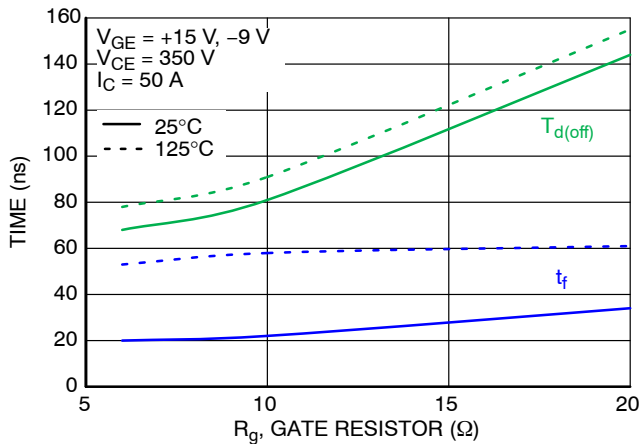
**Figure 10. Typical Turn OFF Loss vs. Rg**



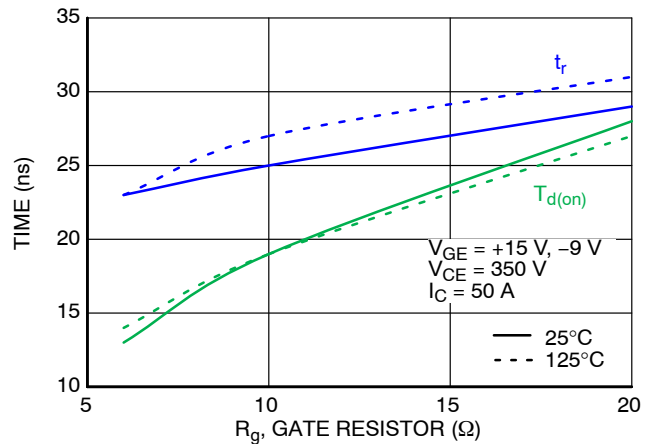
**Figure 11. Typical Turn-Off Switching Time vs. IC**



**Figure 12. Typical Turn-On Switching Time vs. IC**



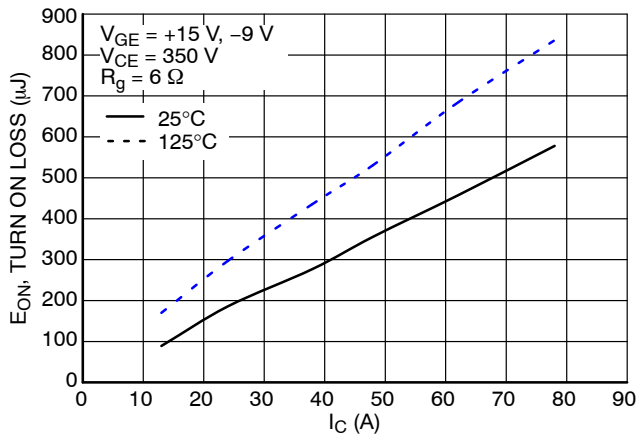
**Figure 13. Typical Turn-Off Switching Time vs. Rg**



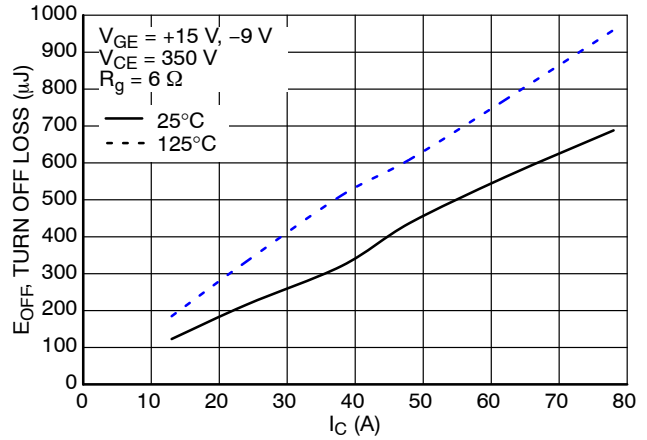
**Figure 14. Typical Turn-On Switching Time vs. Rg**

# NXH50M65L4Q1SG, NXH50M65L4Q1PTG

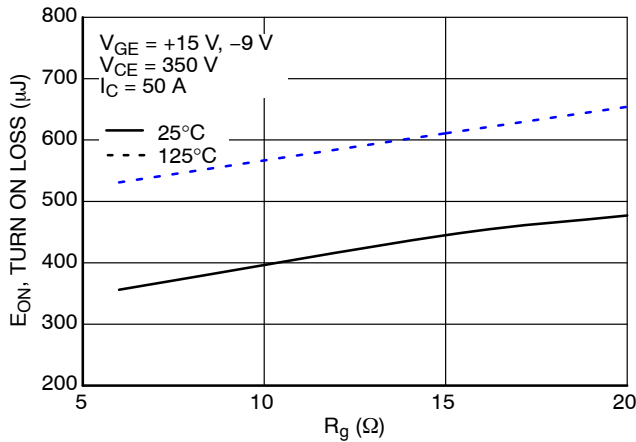
## TYPICAL CHARACTERISTICS – (T21, T22) IGBT COMMUTATES D20 DIODE



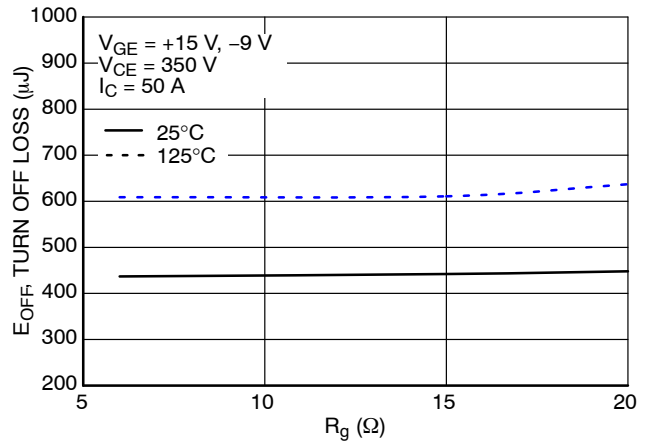
**Figure 15. Typical Turn ON Loss vs. IC**



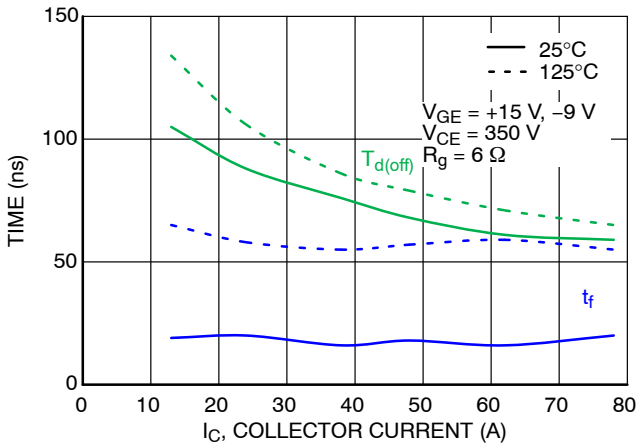
**Figure 16. Typical Turn OFF Loss vs. IC**



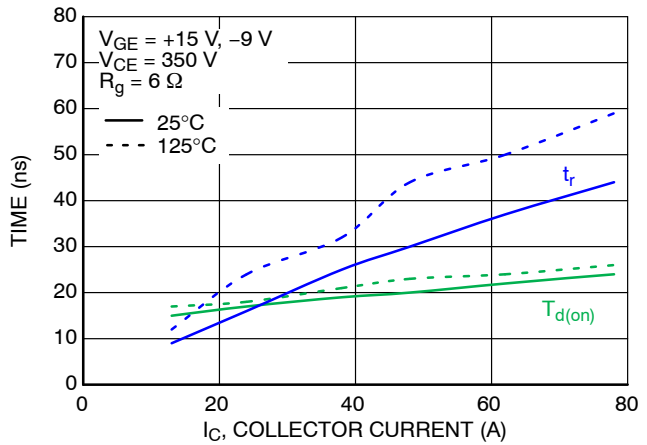
**Figure 17. Typical Turn ON Loss vs. R<sub>G</sub>**



**Figure 18. Typical Turn OFF Loss vs. R<sub>G</sub>**



**Figure 19. Typical Turn-Off Switching Time vs. IC**



**Figure 20. Typical Turn-On Switching Time vs. IC**

# NXH50M65L4Q1SG, NXH50M65L4Q1PTG

## TYPICAL CHARACTERISTICS – (T21, T22) IGBT COMMUTATES D20 DIODE (CONTINUED)

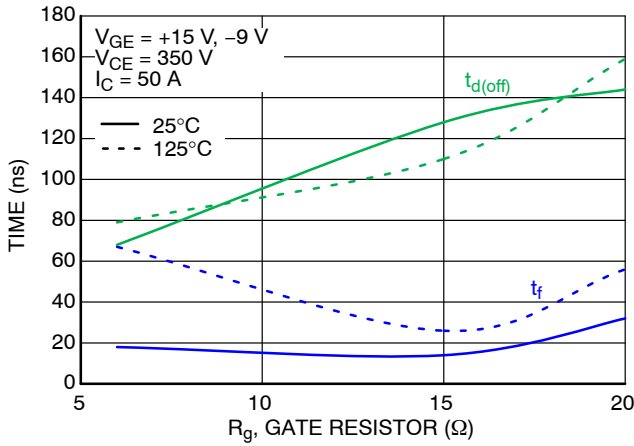


Figure 21. Typical Turn-Off Switching Time vs. Rg

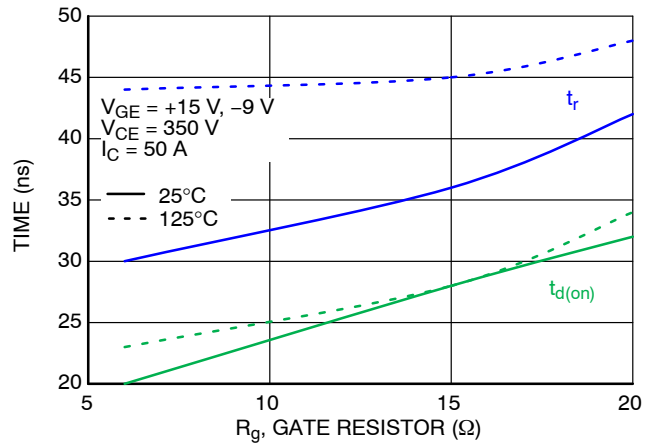


Figure 22. Typical Turn-On Switching Time vs. Rg

## TYPICAL CHARACTERISTICS – DIODE

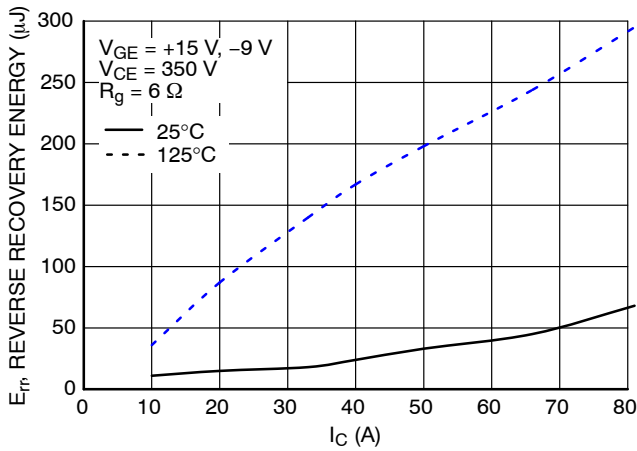


Figure 23. Typical Reverse Recovery Energy Loss vs. IC

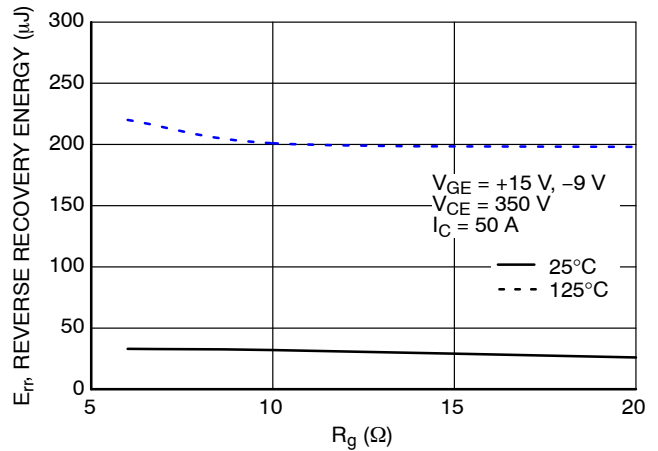


Figure 24. Typical Reverse Recovery Energy Loss vs. Rg

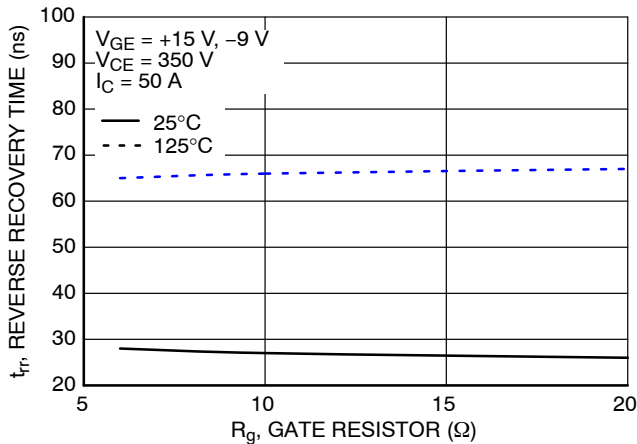


Figure 25. Typical Reverse Recovery Time vs. Rg

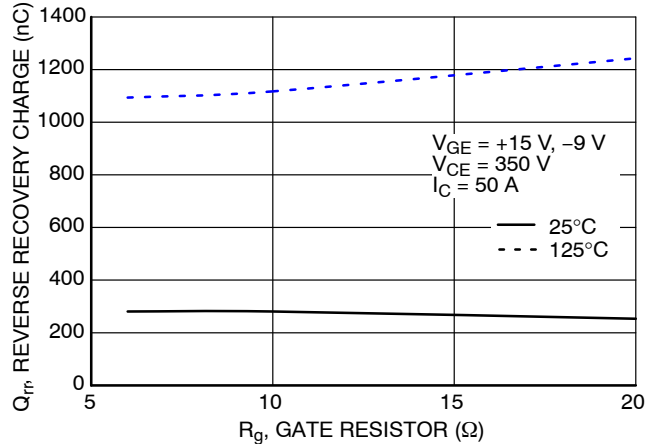


Figure 26. Typical Reverse Recovery Charge vs. Rg

# NXH50M65L4Q1SG, NXH50M65L4Q1PTG

## TYPICAL CHARACTERISTICS – DIODE (CONTINUED)

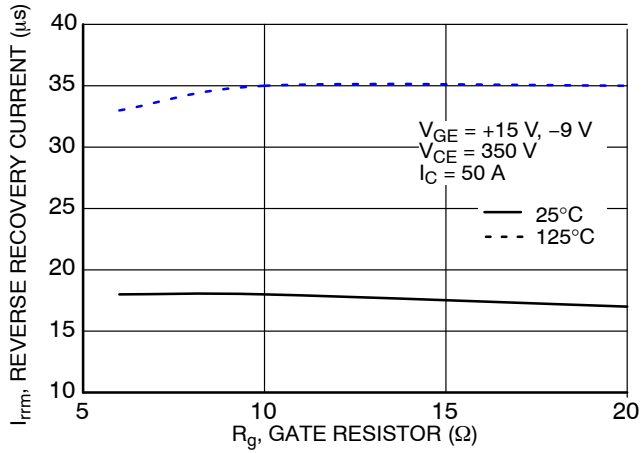


Figure 27. Typical Reverse Recovery Peak Current vs. Rg

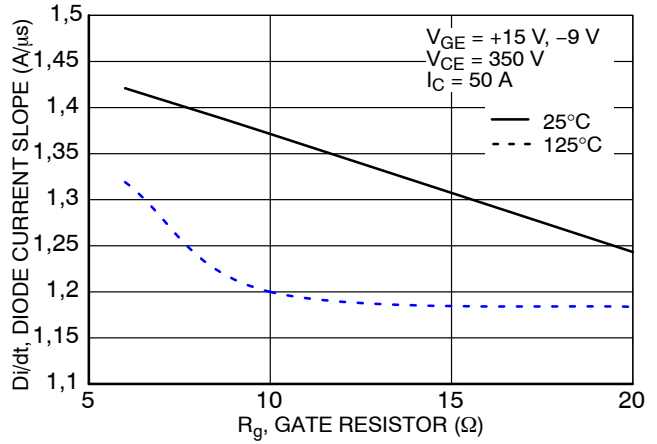


Figure 28. Typical di/dt vs. Rg

## TYPICAL CHARACTERISTICS

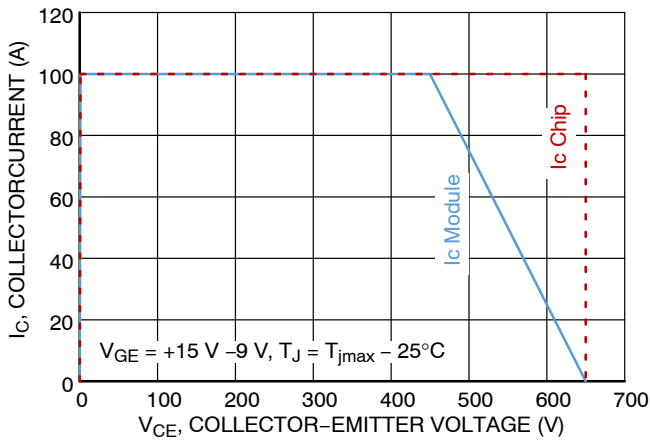


Figure 29. RBSOA Reverse Safe Operating Area

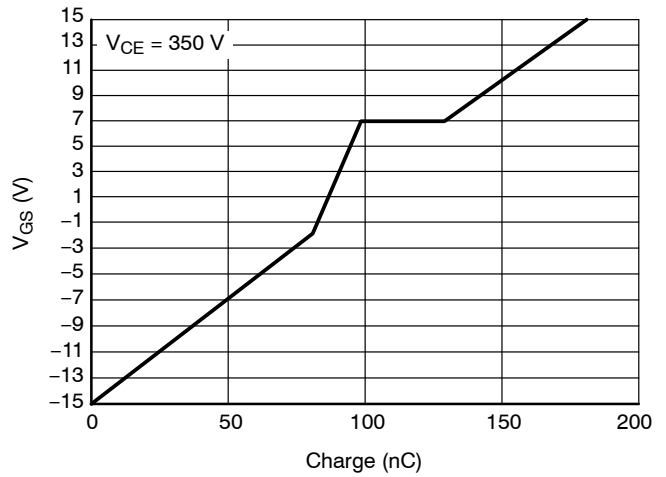


Figure 30. IGBT Gate Charge

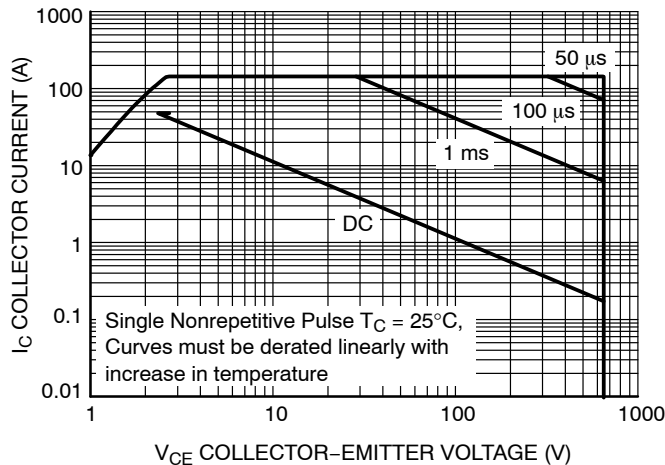


Figure 31. IGBT Safe Operating Area



# NXH50M65L4Q1SG, NXH50M65L4Q1PTG

## TYPICAL THERMAL CHARACTERISTICS

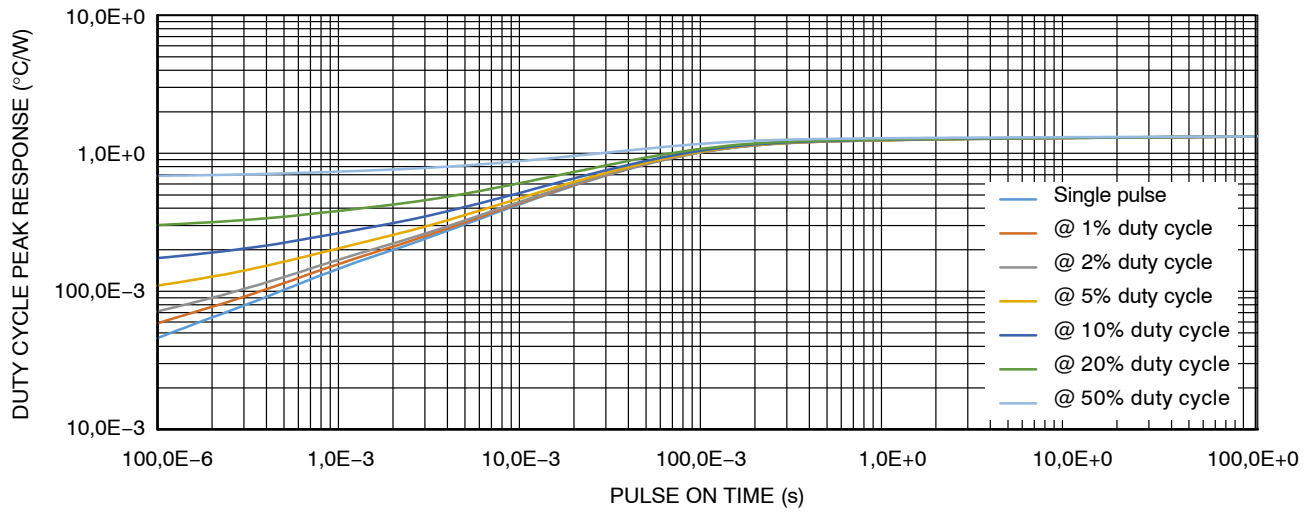


Figure 32. Transient Thermal Impedance – IGBT

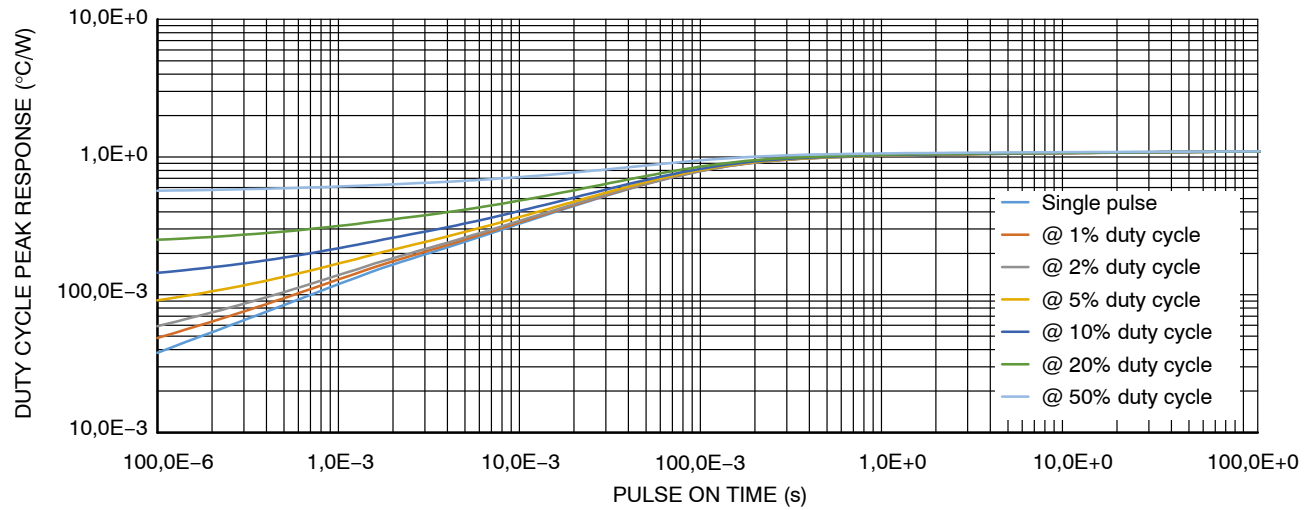


Figure 33. Transient Thermal Impedance – Diode

### ORDERING INFORMATION

Device	Package Type	Status	Shipping
NXH50M65L4Q1SG (Solder Pin)	PIM27, 71x37.4 Q1PACK	In Development	21 Units / BTRAY
NXH50M65L4Q1PTG (Pressfit Pin)	PIM27, 71x37.4 Q1PACK	In Development	21 Units / BTRAY

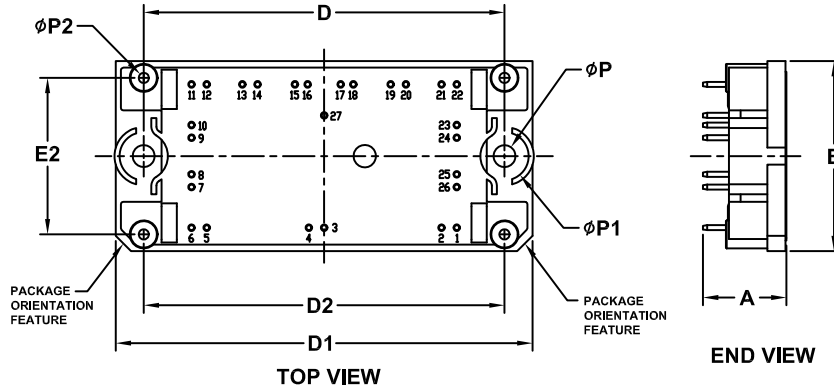
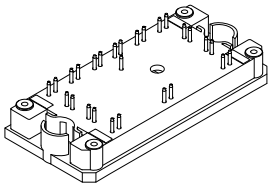
# MECHANICAL CASE OUTLINE

## PACKAGE DIMENSIONS

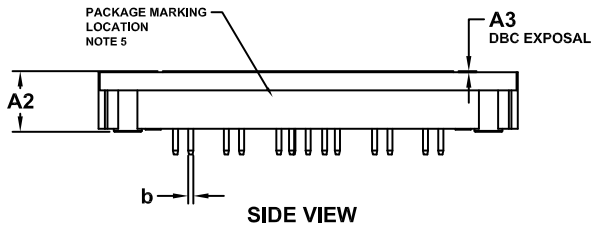


PIM27, 71x37.4 (SOLDER PIN)  
CASE 180CA  
ISSUE B

DATE 14 DEC 2022



DIM	MILLIMETERS		
	MIN.	NOM.	MAX.
A	15.90	16.40	16.90
A2	11.70	11.90	12.10
A3	0.00	0.20	0.60
b	0.95	1.00	1.05
b1	0.75	0.80	0.85
D	70.80	71.00	71.20
D1	81.70	82.00	82.30
D2	70.80	71.00	71.20
E	37.10	37.40	37.70
E2	30.60	30.80	31.00
P	4.10	4.30	4.50
P1	9.30	9.50	9.70
P2	1.80	2.00	2.20



NOTE 4

PIN	PIN POSITION		PIN	PIN POSITION	
	X	Y		X	Y
1	52.20	0.00	15	20.35	28.20
2	49.20	0.00	16	22.85	28.20
3	26.10	0.00	17	29.35	28.20
4	23.10	0.00	18	31.85	28.20
5	3.00	0.00	19	39.20	28.20
6	0.00	0.00	20	42.20	28.20
7	0.00	8.00	21	49.20	28.20
8	0.00	10.50	22	52.20	28.20
9	0.00	17.70	23	52.20	20.20
10	0.00	20.20	24	52.20	17.70
11	0.00	28.20	25	52.20	10.50
12	3.00	28.20	26	52.20	8.00
13	10.00	28.20	27	26.10	22.10
14	13.00	28.20			

NOTES:

1. DIMENSIONING AND TOLERANCING PER ASME Y14.5M, 2009
2. CONTROLLING DIMENSION : MILLIMETERS
3. DIMENSIONS b AND b1 APPLY TO THE PLATED TERMINALS AND ARE MEASURED AT DIMENSION A1
4. PIN POSITION TOLERANCE IS  $\pm 0.4\text{mm}$
5. PACKAGE MARKING IS LOCATED AS SHOWN ON THE SIDE OPPOSITE THE PACKAGE ORIENTATION FEATURES

DOCUMENT NUMBER:	98AON20006H	Electronic versions are uncontrolled except when accessed directly from the Document Repository. Printed versions are uncontrolled except when stamped "CONTROLLED COPY" in red.
DESCRIPTION:	PIM27, 71X37.4 (SOLDER PIN)	PAGE 1 OF 2

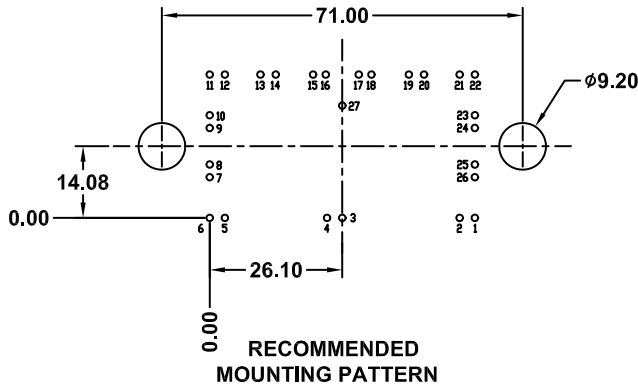
onsemi and onsemi are trademarks of Semiconductor Components Industries, LLC dba onsemi or its subsidiaries in the United States and/or other countries. onsemi reserves the right to make changes without further notice to any products herein. onsemi makes no warranty, representation or guarantee regarding the suitability of its products for any particular purpose, nor does onsemi assume any liability arising out of the application or use of any product or circuit, and specifically disclaims any and all liability, including without limitation special, consequential or incidental damages. onsemi does not convey any license under its patent rights nor the rights of others.

**MECHANICAL CASE OUTLINE  
PACKAGE DIMENSIONS**



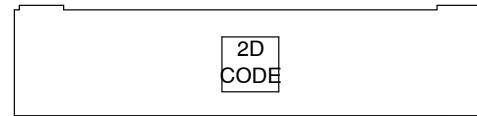
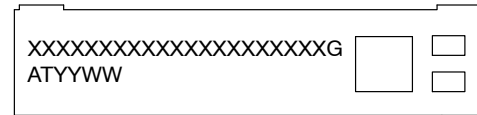
**PIM27, 71x37.4 (SOLDER PIN)  
CASE 180CA  
ISSUE B**

DATE 14 DEC 2022



\* For additional information on our Pb-Free strategy and soldering details, please download the ON Semiconductor Soldering and Mounting Techniques Reference Manual, SOLDERRM/D.

**GENERIC MARKING DIAGRAM\***



XXXXX = Specific Device Code  
G = Pb-Free Device  
AT = Assembly & Test Site Code  
YYWW = Year and Work Week Code

\*This information is generic. Please refer to device data sheet for actual part marking. Pb-Free indicator, "G" or microdot "•", may or may not be present. Some products may not follow the Generic Marking.

<b>DOCUMENT NUMBER:</b>	<b>98AON20006H</b>	Electronic versions are uncontrolled except when accessed directly from the Document Repository. Printed versions are uncontrolled except when stamped "CONTROLLED COPY" in red.
<b>DESCRIPTION:</b>	<b>PIM27, 71X37.4 (SOLDER PIN)</b>	<b>PAGE 2 OF 2</b>

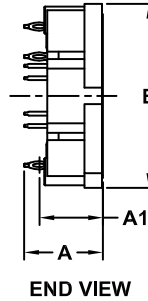
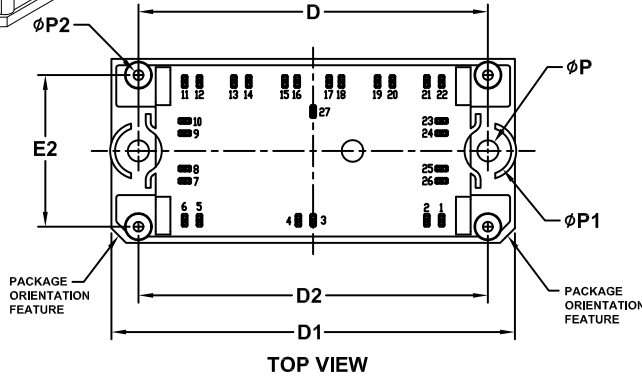
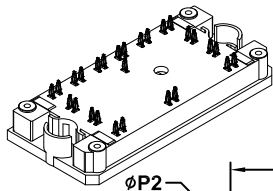
onsemi and onsemi are trademarks of Semiconductor Components Industries, LLC dba onsemi or its subsidiaries in the United States and/or other countries. onsemi reserves the right to make changes without further notice to any products herein. onsemi makes no warranty, representation or guarantee regarding the suitability of its products for any particular purpose, nor does onsemi assume any liability arising out of the application or use of any product or circuit, and specifically disclaims any and all liability, including without limitation special, consequential or incidental damages. onsemi does not convey any license under its patent rights nor the rights of others.

# MECHANICAL CASE OUTLINE PACKAGE DIMENSIONS

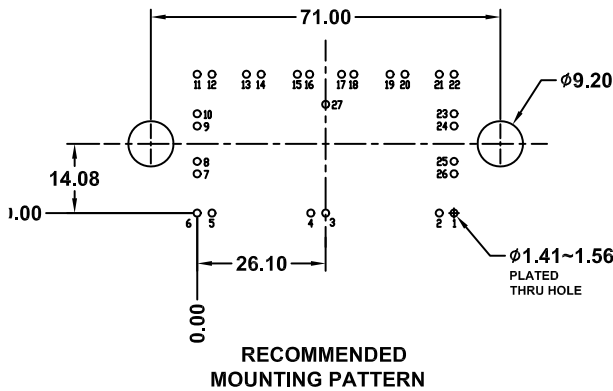
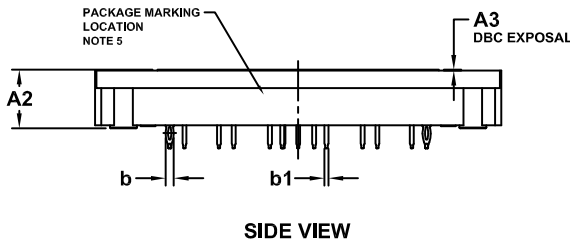


## PIM27, 71x37.4 (PRESSFIT PIN) CASE 180CP ISSUE A

DATE 20 DEC 2022



DIM	MILLIMETERS		
	MIN.	NOM.	MAX.
A	15.50	16.00	16.50
A1	12.38	12.88	13.38
A2	11.70	11.90	12.10
A3	0.00	0.20	0.60
b	1.61	1.66	1.71
b1	0.75	0.80	0.85
D	70.80	71.00	71.20
D1	81.70	82.00	82.30
D2	70.80	71.00	71.20
E	37.10	37.40	37.70
E2	30.60	30.80	31.00
P	4.10	4.30	4.50
P1	9.30	9.50	9.70
P2	1.80	2.00	2.20



NOTE 4

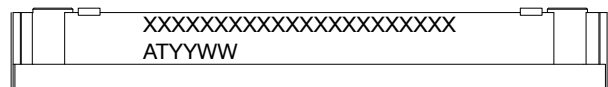
PIN	PIN POSITION		PIN	PIN POSITION	
	X	Y		X	Y
1	52.20	0.00	15	20.35	28.20
2	49.20	0.00	16	22.85	28.20
3	26.10	0.00	17	29.35	28.20
4	23.10	0.00	18	31.85	28.20
5	3.00	0.00	19	39.20	28.20
6	0.00	0.00	20	42.20	28.20
7	0.00	8.00	21	49.20	28.20
8	0.00	10.50	22	52.20	28.20
9	0.00	17.70	23	52.20	20.20
10	0.00	20.20	24	52.20	17.70
11	0.00	28.20	25	52.20	10.50
12	3.00	28.20	26	52.20	8.00
13	10.00	28.20	27	26.10	22.10
14	13.00	28.20			

\* For additional information on our Pb-Free strategy and soldering details, please download the ON Semiconductor Soldering and Mounting Techniques Reference Manual, SOLDERRM/D.

NOTES:

1. DIMENSIONING AND TOLERANCING PER ASME Y14.5M, 2009
2. CONTROLLING DIMENSION : MILLIMETERS
3. DIMENSIONS b AND b1 APPLY TO THE PLATED TERMINALS AND ARE MEASURED AT DIMENSION A1
4. PIN POSITION TOLERANCE IS  $\pm 0.4\text{mm}$
5. PACKAGE MARKING IS LOCATED AS SHOWN ON THE SIDE OPPOSITE THE PACKAGE ORIENTATION FEATURES

### GENERIC MARKING DIAGRAM\*



XXXXX = Specific Device Code  
AT = Assembly & Test Site Code  
YYWW = Year and Work Week Code

\*This information is generic. Please refer to device data sheet for actual part marking. Pb-Free indicator, "G" or microdot "▪", may or may not be present. Some products may not follow the Generic Marking.

DOCUMENT NUMBER:	98AON26650H	Electronic versions are uncontrolled except when accessed directly from the Document Repository. Printed versions are uncontrolled except when stamped "CONTROLLED COPY" in red.
DESCRIPTION:	PIM27, 71X37.4 (PRESSFIT PIN)	PAGE 1 OF 1

onsemi and onsemi are trademarks of Semiconductor Components Industries, LLC dba onsemi or its subsidiaries in the United States and/or other countries. onsemi reserves the right to make changes without further notice to any products herein. onsemi makes no warranty, representation or guarantee regarding the suitability of its products for any particular purpose, nor does onsemi assume any liability arising out of the application or use of any product or circuit, and specifically disclaims any and all liability, including without limitation special, consequential or incidental damages. onsemi does not convey any license under its patent rights nor the rights of others.

**onsemi**, **Onsemi**, and other names, marks, and brands are registered and/or common law trademarks of Semiconductor Components Industries, LLC dba "**onsemi**" or its affiliates and/or subsidiaries in the United States and/or other countries. **onsemi** owns the rights to a number of patents, trademarks, copyrights, trade secrets, and other intellectual property. A listing of **onsemi**'s product/patent coverage may be accessed at [www.onsemi.com/site/pdf/Patent-Marking.pdf](http://www.onsemi.com/site/pdf/Patent-Marking.pdf). **onsemi** reserves the right to make changes at any time to any products or information herein, without notice. The information herein is provided "as-is" and **onsemi** makes no warranty, representation or guarantee regarding the accuracy of the information, product features, availability, functionality, or suitability of its products for any particular purpose, nor does **onsemi** assume any liability arising out of the application or use of any product or circuit, and specifically disclaims any and all liability, including without limitation special, consequential or incidental damages. Buyer is responsible for its products and applications using **onsemi** products, including compliance with all laws, regulations and safety requirements or standards, regardless of any support or applications information provided by **onsemi**. "Typical" parameters which may be provided in **onsemi** data sheets and/or specifications can and do vary in different applications and actual performance may vary over time. All operating parameters, including "Typicals" must be validated for each customer application by customer's technical experts. **onsemi** does not convey any license under any of its intellectual property rights nor the rights of others. **onsemi** products are not designed, intended, or authorized for use as a critical component in life support systems or any FDA Class 3 medical devices or medical devices with a same or similar classification in a foreign jurisdiction or any devices intended for implantation in the human body. Should Buyer purchase or use **onsemi** products for any such unintended or unauthorized application, Buyer shall indemnify and hold **onsemi** and its officers, employees, subsidiaries, affiliates, and distributors harmless against all claims, costs, damages, and expenses, and reasonable attorney fees arising out of, directly or indirectly, any claim of personal injury or death associated with such unintended or unauthorized use, even if such claim alleges that **onsemi** was negligent regarding the design or manufacture of the part. **onsemi** is an Equal Opportunity/Affirmative Action Employer. This literature is subject to all applicable copyright laws and is not for resale in any manner.

## ADDITIONAL INFORMATION

### TECHNICAL PUBLICATIONS:

Technical Library: [www.onsemi.com/design/resources/technical-documentation](http://www.onsemi.com/design/resources/technical-documentation)  
onsemi Website: [www.onsemi.com](http://www.onsemi.com)

### ONLINE SUPPORT: [www.onsemi.com/support](http://www.onsemi.com/support)

For additional information, please contact your local Sales Representative at [www.onsemi.com/support/sales](http://www.onsemi.com/support/sales)