

△数 COUNT	訂正事項 DESCRIPTION OF REVISIONS	検出 CHKD	年月日 DATE	△数 COUNT	訂正事項 DESCRIPTION OF REVISIONS	検出 CHKD	年月日 DATE
1	RE-6-1150	K.I.Y	18. 07. 04				
2	RE-6-1579	K.I.Y	20. 01. 23				

△Design Change

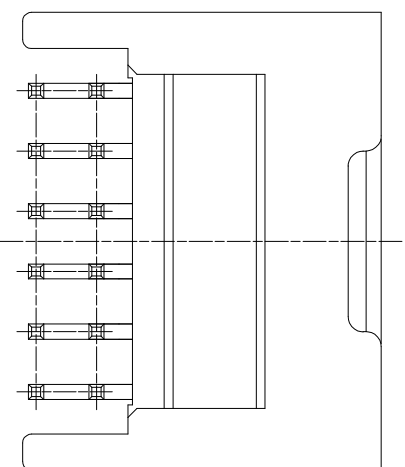

ENGAGEMENT FIGURE (2:1)

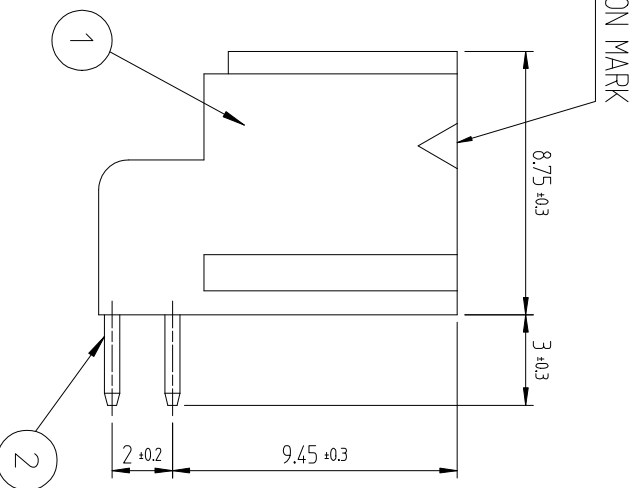
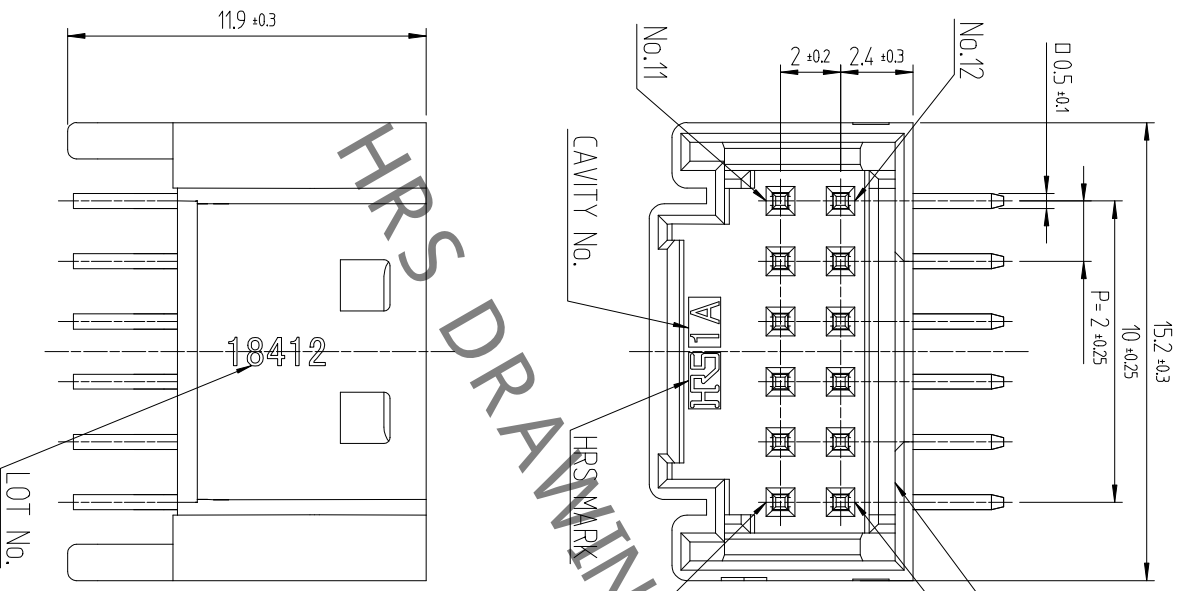
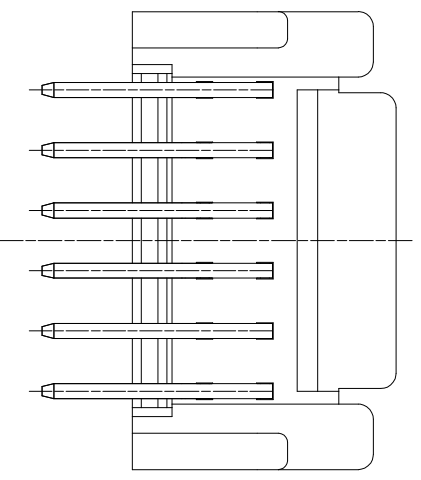
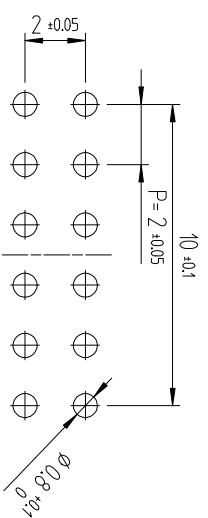
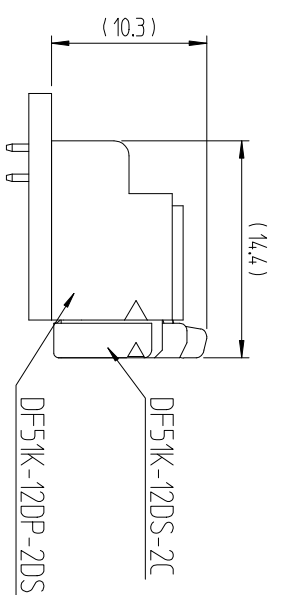
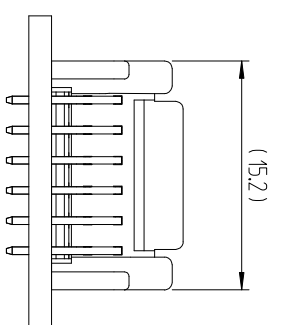

NOTE 1. 1PACK CONTAINS 200PCS.

2. () DIMENSIONS ARE ONLY REFERENCE.

△ 3. UL(FILE No. E132750) AUTHORIZATION ARTICLE.

C-UL(FILE No. E132750) AUTHORIZATION ARTICLE.



1	PBT	UL94V-0, BLACK	2	BRASS	GOLD PLATING 0.1μm MIN. OVER NICKEL 0.5μm MIN.
NO.		MATERIAL	FINISHREMARKS		
CODE NO. (OLD)		FINISHREMARKS			
DRAWN		DESIGNED	CHECKED	APPROVED	RELEASED
CHOI 18.03.02 J.S		CHOI 18.03.02 J.S	LIM 18.03.02 S.M	KANG 18.03.02 T.S	ENG 20.02.12 DEPT
DRAWING NO.		PART NO.			
EDC3-632480		DF51K-12DP-2DS (805)			
SCALE		CODE NO			
4:1		CL 6652-0054-8-805			
UNITS					
mm					



1/1