

High Voltage IC Half Bridge Gate Driver

April 1994

Features

- 500V Maximum Rating
- 2A Peak Gate Drive
- Ability to Interface and Drive N-Channel Power Devices With Complimentary Outputs For Buffered FETs
- Fault Output, Overcurrent Detection and Undervoltage Holdoff
- Over 600kHz Sawtooth Oscillator Frequency
- Adjustable Deadtime Control
- Soft-Start Capability
- Low Current Standby State
- Sleep Mode Reduces Bias Current When Not Enabled

Applications

- Switching and Distributed Power Supplies
- Electronic Lighting Supplies

Ordering Information

PART NUMBER	TEMPERATURE RANGE	PACKAGE
HIP5500IP	-40°C to +85°C	20 Lead Plastic DIP
HIP5500IB	-40°C to +85°C	20 Lead Plastic SOIC (W)

Description

The HIP5500, a high voltage integrated circuit (HVIC) half-bridge gate driver for standard power MOSFETs, IGBTs, and the new Harris Buffered MOSFET (RFV10N50BE), can be employed in a wide variety of switching regulator circuits.

The HIP5500 combines the functionality and flexibility of a PWM IC with the convenience of a high voltage half-bridge driver optimized for power supply inverters. It can be used either open-loop or in closed-loop fashion using the SS input for controlling the output waveform duty-cycle.

The HIP5500 incorporates a precision oscillator, adjustable using an external resistor and capacitor. The resistor sets the capacitor charging current and the capacitor sets the integration time of a triangle wave. Another resistor connected to the DIS pin adjusts the dead-time and can be tailored to the application. The oscillator switches at twice the output waveform fundamental frequency. The result is an output waveform whose positive and negative half-cycles are near perfect balance (volt-second equalization).

Short-Detect (SD) and Soft-Start (SS) inputs provide alternative means for limiting and regulating respectively the half-bridge output voltage. A capacitor on the SS input will begin charging up once the EN input is made high and causes the duty cycle of each half-cycle to "ramp" the duty cycle of the output waveform.

The SD input can sense a signal proportional to current, providing a means of shortening the conduction periods below that imposed by the SS input.

Other circuits within the HIP5500 "match" upper and lower turn-on and turn-off propagation times in order to minimize flux imbalances when driving output transformer loads.

Pinout

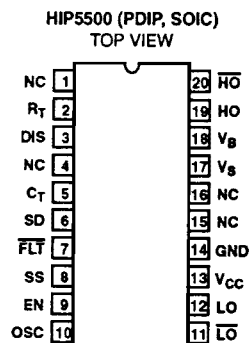

HIP5500

Typical Application Block Diagram

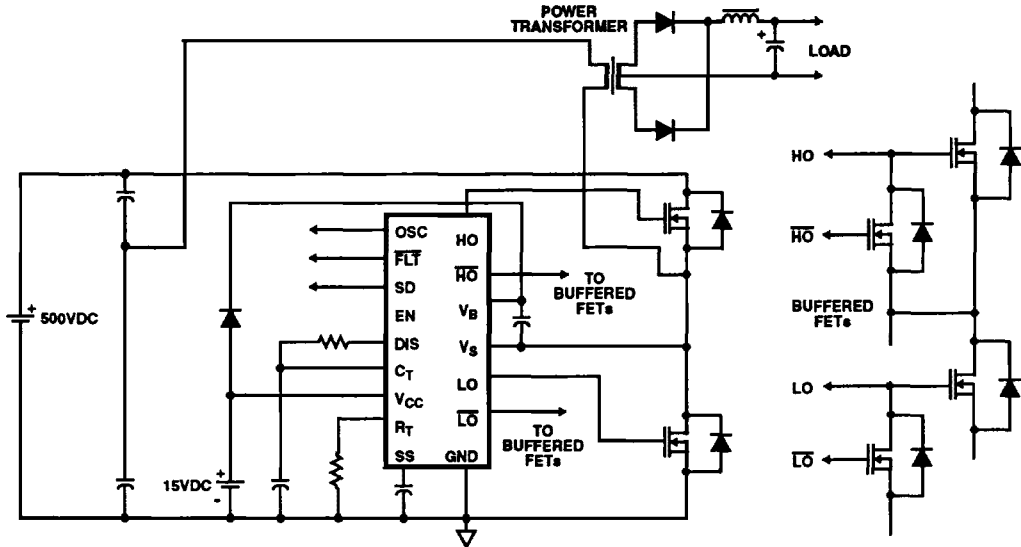

Functional Block Diagram

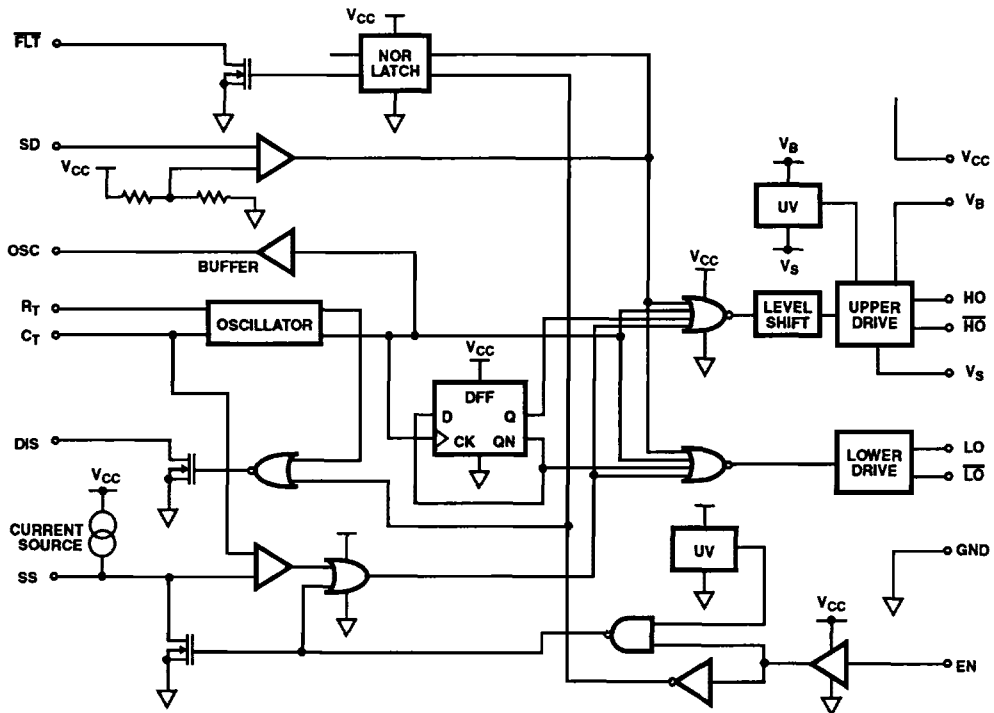

Specifications HIP5500

Absolute Maximum Ratings

Offset Supply Voltage, V_S	$-V_{BS}$ to +500V
Floating Supply Voltage (V_B to V_S)	-0.3V to +18V
High Side Channel Output Voltage, V_{HO} , V_{NHO}	$V_S - 0.5$ to $V_B + 0.5$
Fixed Supply Voltage, V_{CC}	-0.5V to +18V
Low Side Channel Output Voltage	-0.5V to $V_{CC} + 0.5V$
All Other Pin Voltages	
(SD, R_T , C_T , DIS, SS, EN and FLT)	-0.5V to $V_{CC} + 0.5V$
Storage Temperature Range	-40°C to +150°C
Junction Temperature	+125°C
Lead Temperature (Soldering 10s)	+300°C
(SOIC - Lead Tips Only)	
Offset Supply Maximum dv/dt, dV_S/dt	50V/ns
ESD Classification	Class 1

Thermal Information

Thermal Resistance	θ_{JA}
Plastic DIP Package	75°C/W
Plastic SOIC Package	80°C/W
See Maximum Power Dissipation vs Temperature Curve Figure 21	

CAUTION: Stresses above those listed in "Absolute Maximum Ratings" may cause permanent damage to the device. This is a stress only rating and operation of the device at these or any other conditions above those indicated in the operational sections of this specification is not implied.

Recommended Operating Conditions ($T_J = -40^\circ\text{C}$ to $+125^\circ\text{C}$ Unless Otherwise Noted, All Voltages Referenced to V_{SS})

Offset Supply Voltage, V_S	-2.0V to +500V	Discharge Time Constant	100ns Min
Floating Supply Voltage, V_{BS} (V_B to V_S)	+10V to +15V	Discharge Resistor Range, R_{DIS}	100k Ω to 50k Ω
High Side Channel Output Voltage, V_{HO} , V_{NHO}	0V to V_{BS}	Charging Resistor Range, R_T	6.8k Ω to 400k Ω
Fixed Supply Voltage, V_{CC}	+10V to +15V	Oscillator Capacitor Range, C_T	100pF to 0.1 μ F
Low Side Channel Output Voltage, V_{LO} , V_{NLO}	0V to V_{CC}	Oscillator Frequency Range	300kHz Max
All Other Pin Voltages (SD, R_T , C_T , DIS, SS, FLT and EN)	0V to V_{CC}	Oscillator Capacitor Charge Current Range, I_{RT}	21 μ A to 5mA

Electrical Specifications $V_{CC} = V_{BS} = +15V$, $V_S = GND = 0V$, Unless Otherwise Specified

PARAMETER	SYMBOL	TEST CONDITIONS	$T_J = +25^\circ\text{C}$			$T_J = -40^\circ\text{C}$ TO $+125^\circ\text{C}$		UNITS
			MIN	TYP	MAX	MIN	MAX	
Quiescent V_{CC} Current	I_{OCC}		-	5.5	7.0	-	8.0	mA
Quiescent V_{BS} Current	I_{OBS}		-	300	400	-	435	μ A
Quiescent Leakage Current	I_{LK}	$(V_S - GND) = 5.0V$	-	0.4	3.0	-	-	μ A
Standby V_{CC} Current	I_{STBY}	$R_T = 0$	-	2.0	3.5	-	5.0	mA
SS Current Source	$I_{SFT/PWM}$	$\frac{1}{3}V_{CC} < V_{SFT} < \frac{2}{3}V_{CC}$	70	110	145	60	160	μ A
Input Threshold	V_{EN}	Low to High Transition	7.5	7.8	8.5	7.4	8.6	V
Input Hysteresis	V_{EN-HYS}		-	2	-	-	-	V
Undervoltage Threshold	V_{UVHL}	High to Low Transition	7.7	8.6	9.5	7.4	9.6	V
Undervoltage Threshold	V_{UVLH}	Low to High Transition	7.9	8.8	9.7	7.6	9.8	V
Undervoltage Hysteresis	V_{UVHYS}		0.08	0.3	0.7	0.05	0.75	V
Short Detect Threshold	V_{THSD}		3.5	4.0	4.5	3.4	4.6	V
C_T/R_T Current Ratio	I_{CTRAT}	$I_{RT} = 100\mu\text{A}$, $V_{CC}/3 < V_{CT} < \frac{2}{3}V_{CC}$	0.9	1	1.1	0.85	1.15	μ A
HO, LO Peak Output Current	I_{OUT+}	Sourcing, LO, HO = GND	1.5	1.95	-	1.0	-	A
HO, LO Peak Output Current	I_{OUT-}	Sinking, LO, HO = $V_{CC} = V_{BS}$	1.5	2.0	-	1.0	-	A
\overline{LO} , \overline{HO} Peak Output Current	I_{BUF+}	Sourcing, \overline{LO} , $\overline{HO} = V_{SS}$	170	250	-	110	-	mA
\overline{LO} , \overline{HO} Peak Output Current	I_{BUF-}	Sinking, \overline{LO} , $\overline{HO} = V_{CC} = V_{BS}$	170	230	-	110	-	mA
Soft-Start V_{THRESH} , Low to High	V_TSSHL	$C_T = 7.5V$	7.5	7.8	8.1	7.4	8.2	V

Specifications HIP5500

Electrical Specifications $V_{CC} = V_{BS} = +15V, V_S = GND = 0V$, Unless Otherwise Specified (Continued)

PARAMETER	SYMBOL	TEST CONDITIONS	$T_J = +25^\circ C$			$T_J = -40^\circ C$ TO $+125^\circ C$		UNITS
			MIN	TYP	MAX	MIN	MAX	
Soft-Start V_{THRESH} , High to Low	V_TSSLH		7.2	7.5	7.8	7.1	7.9	V
OSC Input Upper Threshold	V_TCTLH		9.8	10.4	11.0	9.7	11.1	V
OSC Input Upper Threshold	V_TCTHL	C_T to DIS	5.0	5.6	6.2	4.9	6.3	V
Oscillator Upper to Lower Threshold Difference	VCTDIF	$V_TCTLH - V_TCTHL$	4.5	4.8	5.1	4.4	5.2	V
OSC_OUT $R_{DS\ ON}$, Sinking	OSCR _{DS} L	$I_{osc_OUT} = -50mA$	5	8.5	12	2	17	Ω
OSC_OUT $R_{DS\ ON}$, Sourcing	OSCR _D H	$I_{osc_OUT} = 50mA$	14	19	30	9	40	Ω
DIS Output On Resistance	$R_{DS\ DIS}$	$I_{DIS} = 10mA$	75	115	150	-	200	Ω
FLT Output On Resistance	$R_{DS\ FLT}$	$I_{FLT} = 5mA$	100	165	230	40	320	Ω

Dynamic Electrical Specifications $V_{CC} = V_{BS} = +15V, GND = 0V$, Unless Otherwise Specified

PARAMETER	SYMBOL	TEST CONDITIONS	$T_J = +25^\circ C$			$T_J = -40^\circ C$ TO $+125^\circ C$		UNITS
			MIN	TYP	MAX	MIN	MAX	
Turn-On Rise Time, HO, LO	t_{DR}	$C_L = 2000pF$	-	-	50	-	-	ns
Turn-Off Fall Time, HO, LO	t_{DF}	$C_L = 2000pF$	-	-	50	-	-	ns
Turn-On Rise Time, \overline{HO} , \overline{LO}	t_{DNR}	$C_{BUF} = 200pF$	-	25	35	-	-	ns
Turn-Off Fall Time, \overline{HO} , \overline{LO}	t_{DNF}	$C_{BUF} = 200pF$	-	25	35	-	-	ns
C_T Fall to LO/HO Rise	T_{PCTLH}	$C_T = V_TCTHL$ LO/HO LOAD = 200pF	-	475	700	-	925	ns
C_T Rise to LO/HO Fall	T_{PCTHL}	$C_T = V_TCTLH$ LO/HO LOAD = 200pF	-	475	700	-	925	ns
LO-HO Prop Delay Mismatch	Delmatch	T_{PCTLH} and T_{PCTHL}	-	60	-	-	-	ns
C_T Rise to DIS Fall	$T_{PCTDISHL}$	$C_T = V_TCTHL$	-	300	450	-	475	ns
C_T Fall to DIS Rise	$T_{PCTDISLH}$	$C_T = V_TCTLH$	-	600	800	-	825	ns
Minimum Dead Time	t_{DTMIN}		-	200	-	-	-	ns
Short Detect Propagation Delay	$t_{SDLO/HO}$	$SD = V_{THSD}$, LO/HO = 200pF	-	425	850	-	1100	ns
Soft-Start Propagation Delay Time	t_{SSDLY}	$SS = V_TSSLH$, LO/HO = 200pF	-	500	750	-	775	ns

HIP5500

Typical Performance Curves All Curves are $V_{CC} = +15V$, $T_A = +25^\circ C$, Unless Otherwise Specified

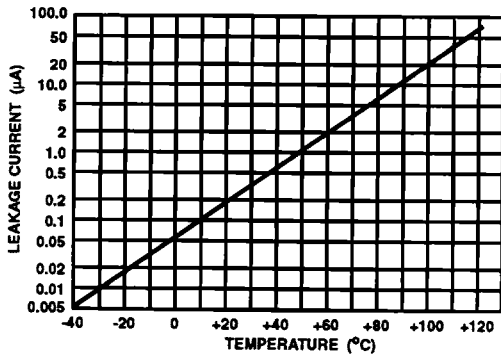

FIGURE 1. OFFSET SUPPLY LEAKAGE CURRENT vs TEMPERATURE AT 300VDC

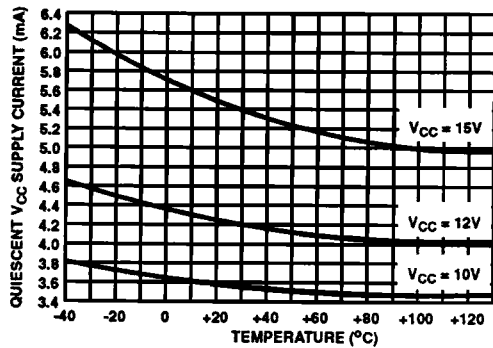

FIGURE 2. QUIESCENT V_{CC} CURRENT vs TEMPERATURE AND V_{CC} SUPPLY VOLTAGE

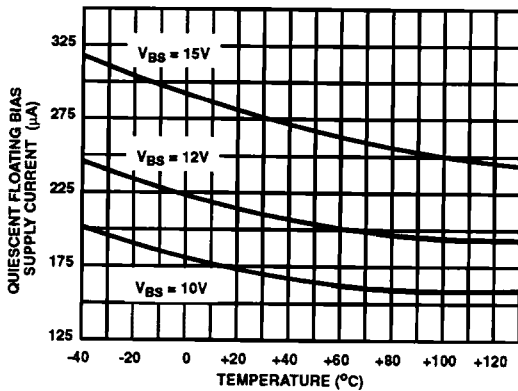

FIGURE 3. QUIESCENT FLOATING BIAS SUPPLY CURRENT vs TEMPERATURE AND V_{BS} SUPPLY VOLTAGE

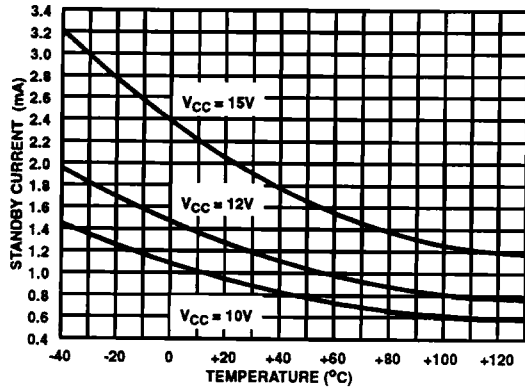

FIGURE 4. QUIESCENT STANDBY CURRENT vs TEMPERATURE AND V_{CC} SUPPLY VOLTAGE

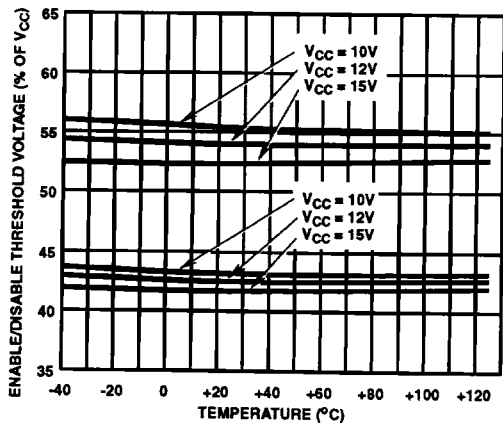

FIGURE 5. ENABLE/DISABLE THRESHOLD (PERCENT V_{CC}) vs TEMPERATURE AND V_{CC} SUPPLY VOLTAGE

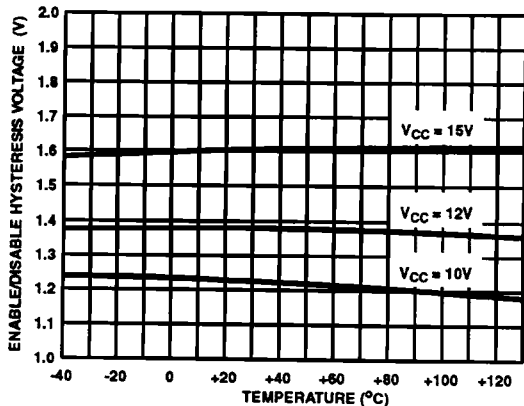

FIGURE 6. ENABLE/DISABLE HYSTERESIS VOLTAGE vs TEMPERATURE AND V_{CC} SUPPLY VOLTAGE

Typical Performance Curves All Curves are $V_{CC} = +15V$, $T_A = +25^\circ C$, Unless Otherwise Specified (Continued)

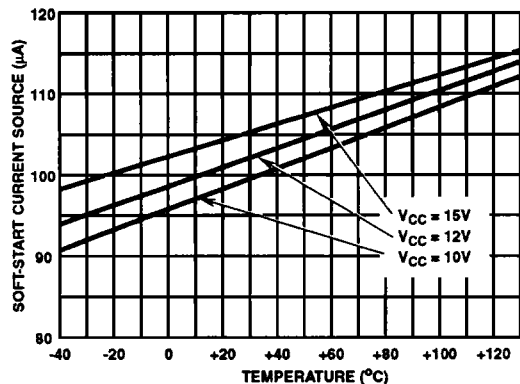

FIGURE 7. SOFT-START CURRENT SOURCE CURRENT vs TEMPERATURE AND V_{CC} SUPPLY VOLTAGE

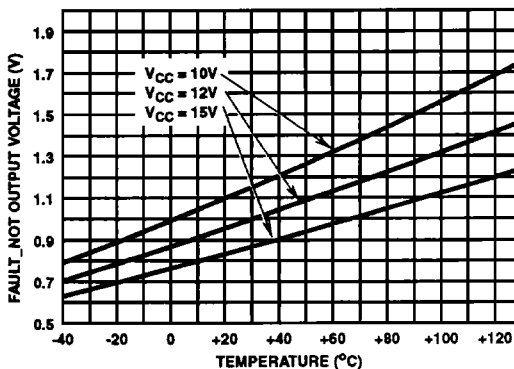

FIGURE 8. FAULT_NOT LOW LEVEL OUTPUT VOLTAGE vs TEMPERATURE AND V_{CC} SUPPLY VOLTAGE, SINKING 5mA

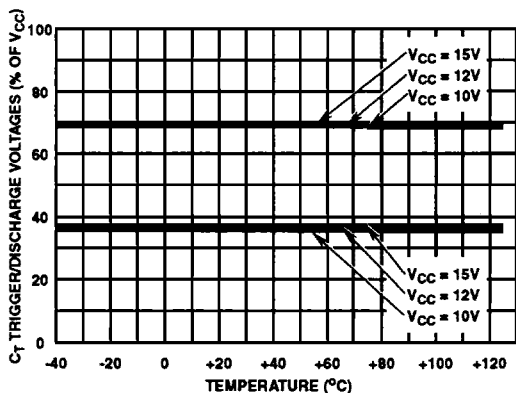

FIGURE 9. C_T RAMP TRIGGER AND DISCHARGE VOLTAGE TRIP POINT vs TEMPERATURE AND V_{CC} SUPPLY VOLTAGE

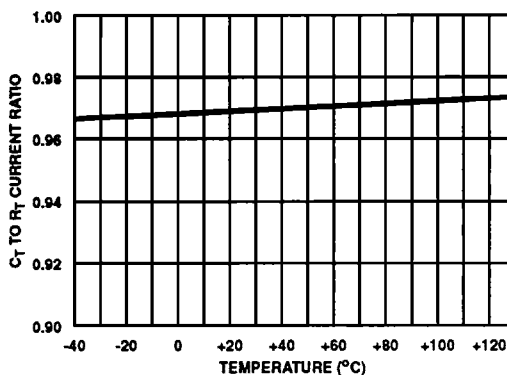

FIGURE 10. C_T TO R_T CURRENT SOURCE RATIO vs TEMPERATURE

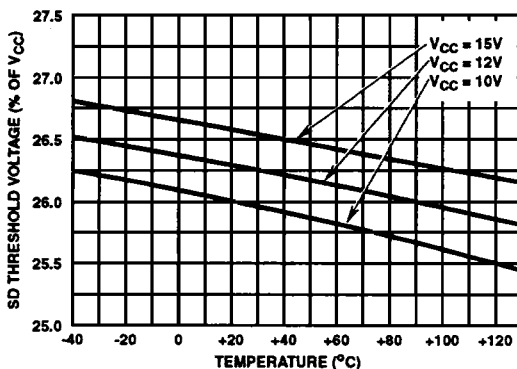

FIGURE 11. SHUTDOWN THRESHOLD VOLTAGE (% OF V_{CC}) vs TEMPERATURE AND V_{CC} SUPPLY VOLTAGE

Typical Performance Curves All Curves are $V_{CC} = +15V$, $T_A = +25^\circ C$, Unless Otherwise Specified (Continued)

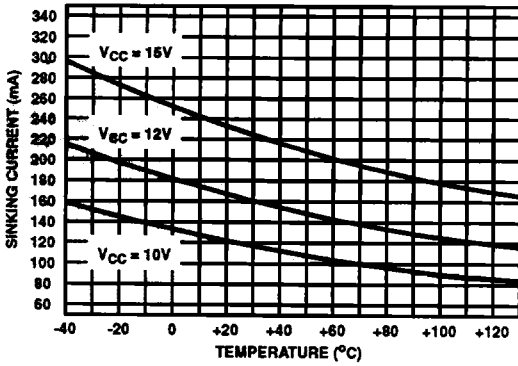

FIGURE 12. BUFFER GATE OUTPUT SHORT CIRCUIT SINKING CURRENT vs TEMPERATURE AND V_{CC} SUPPLY VOLTAGE

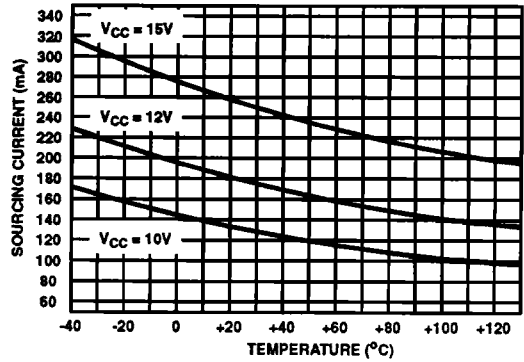

FIGURE 13. BUFFER GATE OUTPUT SHORT CIRCUIT SOURCING CURRENT vs TEMPERATURE AND V_{CC} SUPPLY VOLTAGE

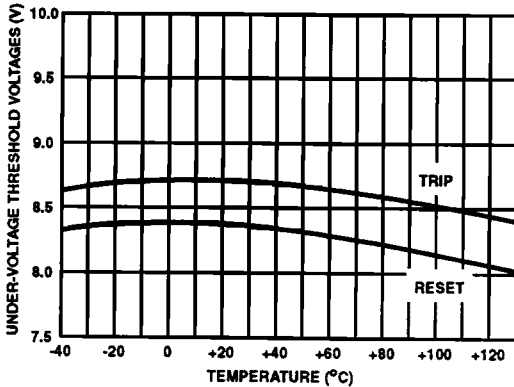

FIGURE 14. LOW-SIDE UNDERVOLTAGE THRESHOLD VOLTAGE (TRIP/RESET) vs TEMPERATURE

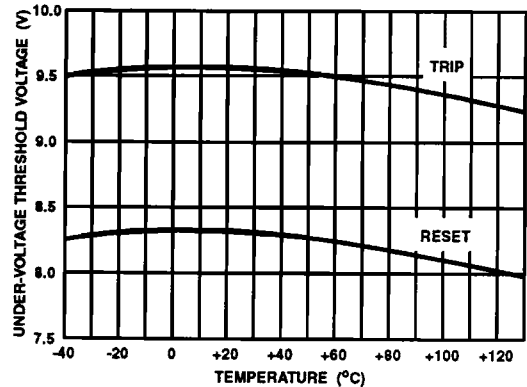

FIGURE 15. HIGH-SIDE UNDERVOLTAGE THRESHOLD VOLTAGE (TRIP/RESET) vs TEMPERATURE

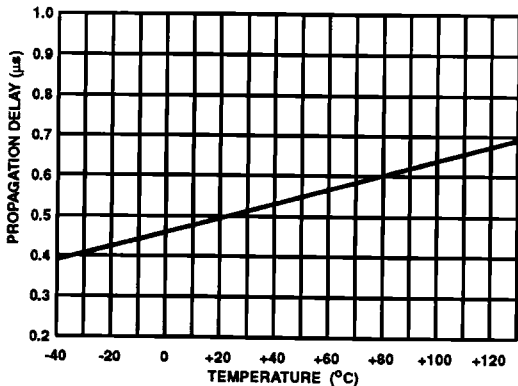

FIGURE 16. PROPAGATION DELAY, C_T TO GATE OUTPUTS vs TEMPERATURE AT $V_{CC} = +15V$

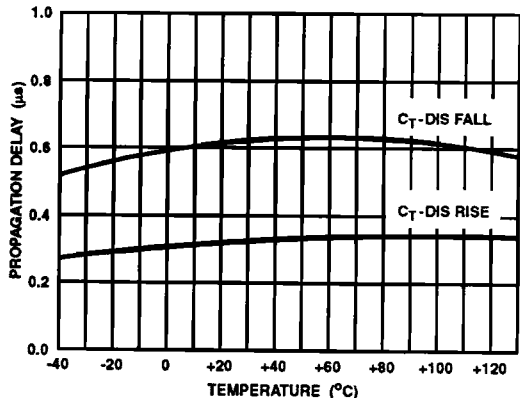

FIGURE 17. PROPAGATION DELAY, C_T TO DIS vs TEMPERATURE AT $V_{CC} = +15V$

Typical Performance Curves All Curves are $V_{CC} = +15V$, $T_A = +25^\circ C$, Unless Otherwise Specified (Continued)

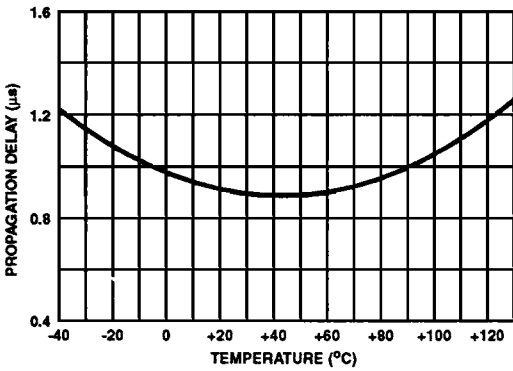

FIGURE 18. PROPAGATION DELAY, SS TO LO GATE RISING vs TEMPERATURE AT $V_{CC} = +15V$

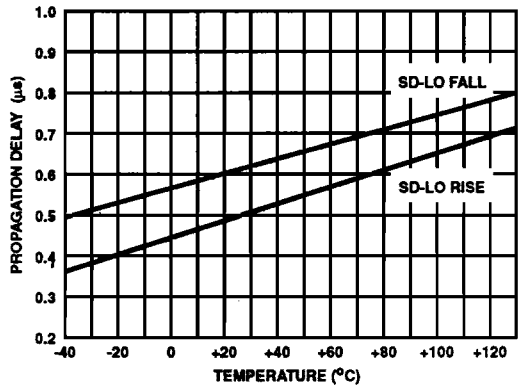

FIGURE 19. PROPAGATION DELAYS, SD TO LO GATE RISE/FALL vs TEMPERATURE AT $V_{CC} = +15V$

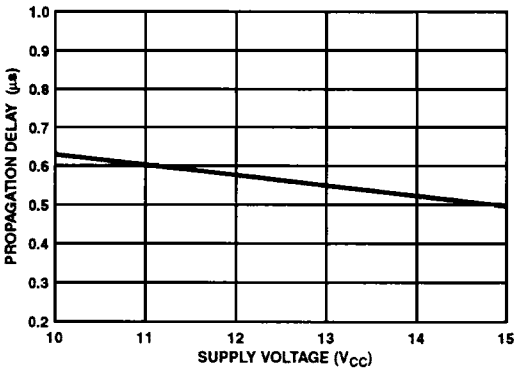

FIGURE 20. PROPAGATION DELAY, C_T TO GATE OUT vs SUPPLY VOLTAGE, V_{CC} AT $+25^\circ C$ FOR RISING AND FALLING GATE OUTPUTS

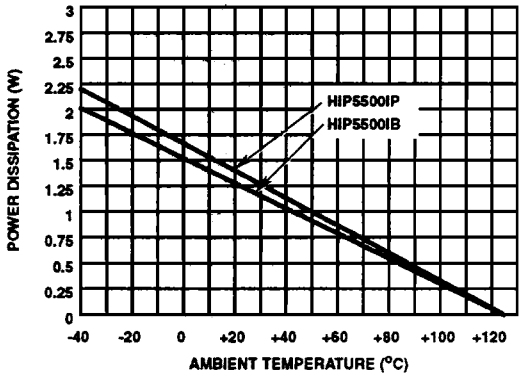

FIGURE 21. MAXIMUM POWER DISSIPATION vs TEMPERATURE

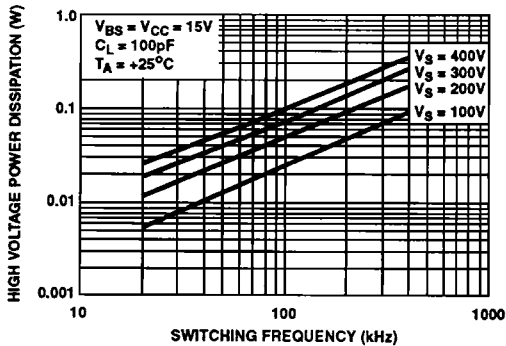
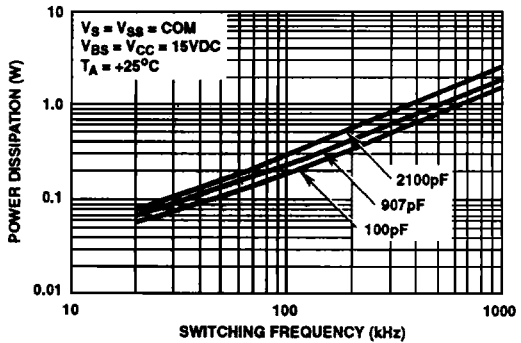

FIGURE 22. HIGH VOLTAGE POWER DISSIPATION vs SWITCHING FREQUENCY



NOTE: All switching losses assumed to be in IC.

FIGURE 23. LOW VOLTAGE POWER DISSIPATION vs FREQUENCY

HIP5500

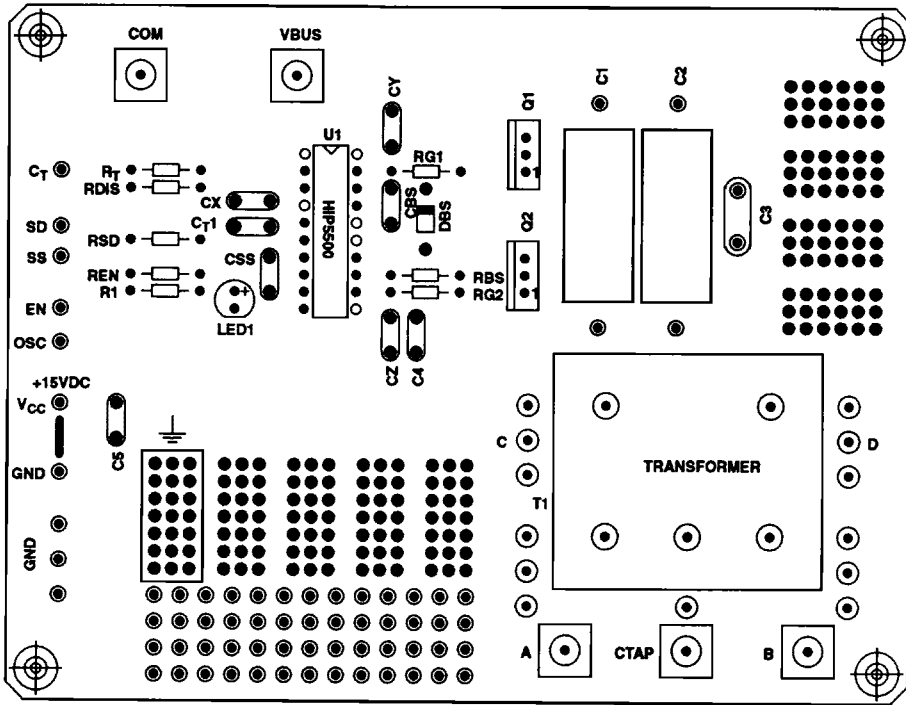

FIGURE 25. HIP5500 EVALUATION BOARD SILKSCREEN