

MAX31914

Ultra-Low Power Industrial, Octal, Digital Input Translator

General Description

The MAX31914 translates and conditions the 24V digital output of sensors and switches used in industrial, process, and building automation to 5V CMOS-compatible signals required by microcontrollers. It provides the front-end interface circuit of a programmable logic controller (PLC) digital input module.

The signal voltage translation is performed in conjunction with input current limiting and lowpass filtering. Input current limiting allows a significant reduction in power consumed from the field-supply voltage, as compared to traditional discrete resistor-divider implementations. To achieve the lowest in-class power dissipation, the IC uses patent-pending circuit techniques to achieve further reduction of power dissipation beyond what is possible by input current limiting alone. This special low-power operating mode is automatically activated when on-chip lowpass filtering is selected.

Selectable on-chip lowpass filters allow flexible debouncing and filtering of sensor inputs based on the application. When no filtering is selected, the IC is capable of detecting pulses as short as 0.75 μ s at its field inputs.

All 8 input channels are translated to CMOS logic levels and presented in parallel on the eight output pins for direct or galvanically isolated interface with a controller ASIC or micro.

The on-chip 5V voltage regulator can be used to power external optocouplers, digital isolators, or other external 5V circuitry.

For low-cost applications, Maxim Integrated offers a pin compatible version of this device, the MAX31915, which does not include the current-switching circuitry included in the MAX31914.

Applications

- Digital Input Modules for Programmable Logic Controllers (PLCs)
- Industrial Automation, Building Automation
- Process Automation

Benefits and Features

- Flexible Supply Options Enables Usage in 24V, 12V, and 5V Supplied Systems
 - 7V to 36V Wide Operating Field-Supply Range
 - Device Can Be Optionally Powered from the Logic-Side Using a 5V Supply
- Low Power and Low Heat Dissipation
 - Very Low Quiescent Current
 - Extremely Accurate and Stable Input Current Limiters
 - Special Ultra-Low-Power Operating Mode with Switched Current Limiters
- Configurability Enables a Wide Range of Standard and Custom Applications
 - Configurable Inputs for IEC 61131-2 Input Types 1, 2, and 3 or for Standard CMOS Logic Levels
 - 0.5mA to 6mA Configurable Input Current Limiting
 - Selectable Input Filtering and Debounce: 0, 25 μ s, 0.75ms, and 3ms Settings
- High Integration Reduces BOM Count and Board Space
 - 8 High-Voltage Input Channels (36V Max)
 - 8 CMOS Logic Outputs for High-Speed Simultaneous Transfer of All Input States to the Controller
 - On-Chip 5V Regulator
 - On-Chip Overtemperature Indicator
 - On-Chip Field-Supply Voltage Monitor
 - High HBM ESD Immunity on all Field Input Pins (15kV HBM)

Ordering Information appears at end of data sheet.

Block Diagram

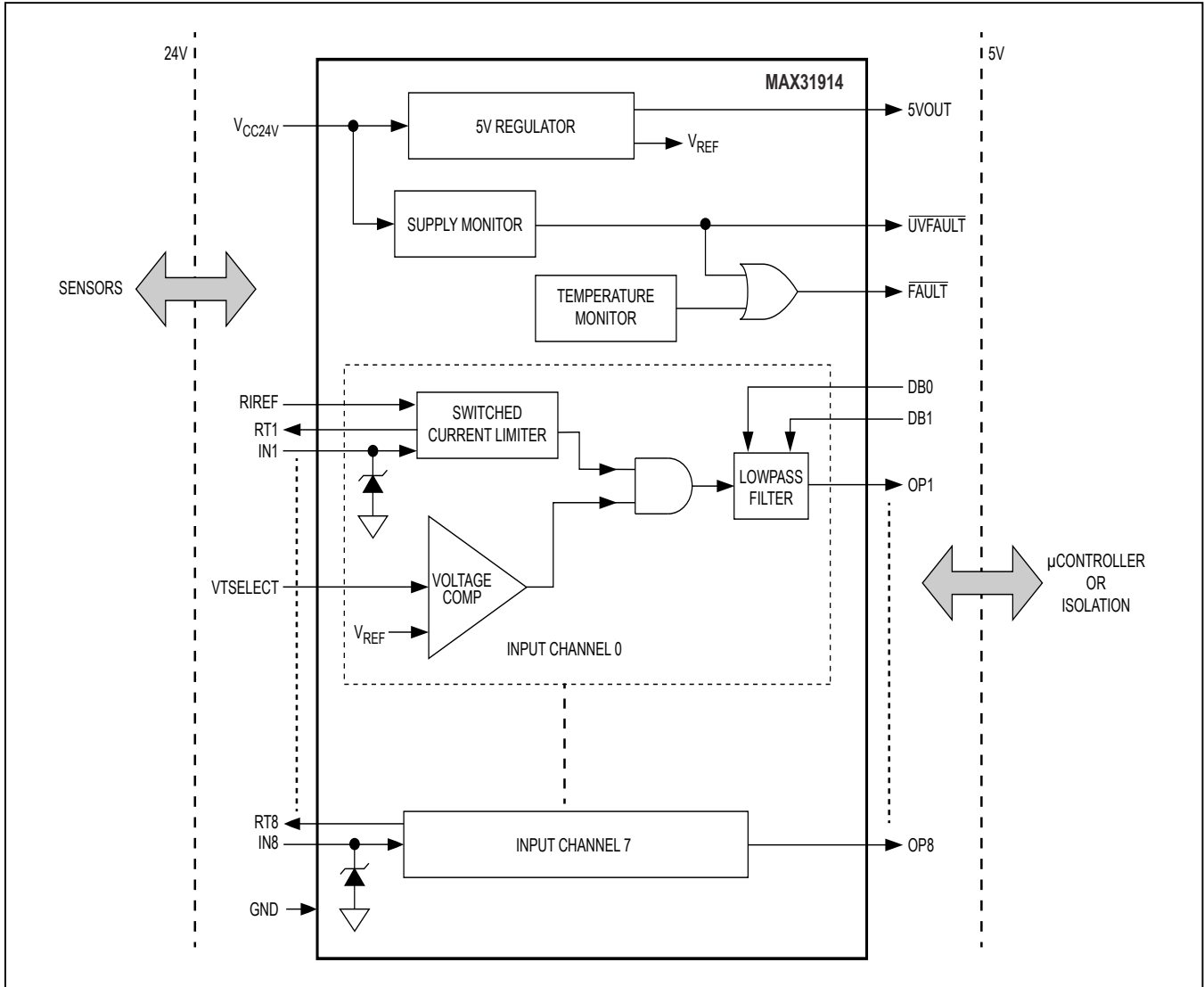

Absolute Maximum Ratings

Voltage on V _{CC24V} Relative to GND	-0.3V to +45V	Junction Temperature Range	-40°C to +150°C
Voltage on IN1–IN8 Relative to GND through 2.2kΩ Resistors	-45V to +45V	Storage Temperature Range	-55°C to +125°C
Voltage on DB0/DB1, VTSELECT Relative to GND	-0.3V to 6V + 0.3V	Continuous Power Dissipation (T _A = +70°C) (derate 22.2mW/°C above +70°C)	1773.8mW
Ambient Temperature Range	-40°C to +125°C	Soldering Temperature, Lead(Pb)-Free (reflow)	260°C
		Lead Temperature (soldering, 10s)	300°C

Stresses beyond those listed under "Absolute Maximum Ratings" may cause permanent damage to the device. These are stress ratings only, and functional operation of the device at these or any other conditions beyond those indicated in the operational sections of the specifications is not implied. Exposure to absolute maximum rating conditions for extended periods may affect device reliability.

Package Thermal Characteristics (Note 1)

TSSOP

Junction-to-Ambient Thermal Resistance (θ _{JA})	45.10°C/W
Junction-to-Case Thermal Resistance (θ _{JC})	1°C/W

Note 1: Package thermal resistances were obtained using the method described in JEDEC specification JESD51-7, using a four-layer board. For detailed information on package thermal considerations, refer to www.maximintegrated.com/thermal-tutorial.

Recommended Operating Conditions

PARAMETER	SYMBOL	CONDITIONS	MIN	TYP	MAX	UNITS
Field-Supply Voltage	V _{CC24V}	Note 2	7		36	V
Field Inputs Voltage	V _{Inn}	Note 3	-0.3		+36	V
Logic Inputs Voltage	V _{LOGIC}		-0.3		+5.5	V
Current-Limit Setting Resistor	R _{REF}	VTSELECT = logic 1		15		kΩ
		VTSELECT = logic 0		150		

DC Electrical Characteristics

(T_A = -40°C to +125°C, T_J ≤ 150°C, V_{CC24V} = 7V to 36V, unless otherwise noted.)

PARAMETER	SYMBOL	CONDITIONS	MIN	TYP	MAX	UNITS
Field-Supply Current	I _{CC24V}	IN1–IN8 = 24V, 5VOUT = open, OP1–OP8 and all logic inputs = open		1.6	2.3	mA
Field-Supply Low Alarm Off-On	V _{ONUVLO}		7	8		V
Field-Supply Low Alarm On-Off	V _{OFFUVLO}			9	10	V
Field Input Threshold, High to Low	V _{IN1-(INF)}	2.2kΩ external series resistor, VTSELECT = logic 1, R _{REF} = 15kΩ	7	8.4		V
Field Input Threshold, Low to High (Note 4)	V _{IN1+(INF)}	2.2kΩ external series resistor, VTSELECT = logic 1, R _{REF} = 15kΩ		9.4	10.5	V
Field Input Hysteresis (Note 4)	V _{HYS1(INF)}	2.2kΩ external series resistor, VTSELECT = logic 1, R _{REF} = 15kΩ		1		V
Field Input Threshold, High to Low	V _{IN0-(INF)}	2.2kΩ external series resistor, VTSELECT = logic 0, R _{REF} = 150kΩ	1.5	1.7		V

DC Electrical Characteristics (continued)(T_A = -40°C to +125°C, T_J ≤ 150°C, V_{CC24V} = 7V to 36V, unless otherwise noted.)

PARAMETER	SYMBOL	CONDITIONS	MIN	TYP	MAX	UNITS
Field Input Threshold, Low to High	VIN0+(INF)	2.2kΩ external series resistor, VTSELECT = logic 0, R _{REF} = 150kΩ		2.2	3.5	V
Field Input Hysteresis (Note 4)	VHYS0(INF)	2.2kΩ external series resistor, VTSELECT = logic 0, R _{REF} = 150kΩ		0.5		V
Input Threshold, High to Low (at IC Pin)	VTH1-(INP)	VTSELECT = logic 1, R _{REF} = 15kΩ	3	3.4		V
Input Threshold, Low to High (at IC Pin) (Note 4)	VTH1+(INP)	VTSELECT = logic 1, R _{REF} = 15kΩ		4.4	5	V
Input Threshold Hysteresis (at IC Pin) (Note 4)	VHYS1(INP)	VTSELECT = logic 1, R _{REF} = 15kΩ		1		V
Input Threshold, High to Low (at IC Pin)	VTH0-(INP)	VTSELECT = logic 0, R _{REF} = 150kΩ	1.5	1.7		V
Input Threshold, Low to High (at IC Pin)	VTH0+(INP)	VTSELECT = logic 0, R _{REF} = 150kΩ		2.2	3.5	V
Input Threshold Hysteresis (at IC Pin)	VHYS0(INP)	VTSELECT = logic 0, R _{REF} = 150kΩ		0.5		V
Field Pin Input Resistance	R _{INP}			0.8		kΩ
Field Input Current Limit	I _{INLIM}	R _{REF} = 15 kΩ (Note 5), VTSELECT = logic 1	2.26	2.45	2.72	mA
Filter Time Constant	t _{FILTER}	DB1/DB0 = 0/0: no filtering		0		ms
		DB1/DB0 = 0/1	0.008	0.025	0.038	
		DB1/DB0 = 1/0	0.25	0.75	1.1	
		DB1/DB0 = 1/1	1.0	3	4.5	
Linear Regulator Output	V _{5VOUT}	Max I _{ILOAD} = 50mA	4.75	5.0	5.25	V
Regulator Line Regulation	dVREG _{LINE}	I _{ILOAD} = 50mA		10		mV
Regulator Load Regulation	dVREG _{LOAD}	I _{ILOAD} = 1mA to 50mA		20		mV
Logic-Low Output Voltage	V _{OL}	I _{OL} = 4mA		0.4	1.0	V
Logic-High Output Voltage	V _{OH}	I _{OH} = -4mA	4.0			V
Logic Input Leakage Current	I _{IL}	All inputs have internal pullups	-50	-30	-15	μA
Overtemperature Alarm	T _{ALRM}			135		°C
LED On-State Current		R _{REF} = 15kΩ, DB0, DB1 = 0, 0 (current switching disabled)		2.2		mA

AC Electrical Characteristics(T_A = -40°C to +125°C, T_J ≤ 150°C, V_{CC24V} = 7V to 36V, unless otherwise noted.)

PARAMETER	SYMBOL	CONDITIONS	MIN	TYP	MAX	UNITS
Input Data Rate	f _{IN}	DB0, DB1 = 0, 0 (filters disabled)			1.3	Mbps
Input Pulse Width	PW _{IN}	DB0, DB1 = 0, 0 (filters disabled)	0.75			μs
Interchannel Propagation-Delay Mismatch (Interchannel Jitter)	φ _{int}	(Note 6)			25	ns
Propagation Delay	t _{PROP}	12V input applied on the field side through external 2.2kΩ resistors, R _{REF} set to 15k, VTSEL = 1 (Notes 7, 8)		300	700	ns
Output Rise/Fall Times (on OPn Pins)	t _{R/F}	Internally slew limited (with C _{LOAD} = 0–50pF)		25		ns
ESD		HBM, all pins		±2		kV
		HBM, IN1–IN8 with respect to GND		±15		

Note 2: If a 24V supply is not available, the device can be powered through 5VOUT. In this mode of operation, the V_{CC24V} supply must be left unconnected. All other specifications remain identical. The field-supply alarms are asserted indicating the absence of the 24V supply in this mode of operation.

Note 3: When using suggested external 2.2kΩ series resistors, limits of -36V to +36V apply.

Note 4: When input current switching is enabled (DB0/DB1 = 0), there is no input threshold hysteresis. In this case, the input threshold for both falling and rising signals is the high to low threshold.

Note 5: External resistor R_{REF} can be adjusted to set any desired current limit between 0.5mA and 6mA.

Note 6: INn-to-OPn propagation delay difference between two channels on the same IC.

Note 7: Propagation delay from field input (INn) to CMOS output (OPn). Tested with a 6.5V pulse applied directly to the device INn pins. Propagation delay is measured between the 50% transitions of the rising and falling edges.

Note 8: The propagation delay limit is 1ms maximum when VTSEL = 0.

Typical Operating Characteristics

($T_A = +25^\circ\text{C}$, $R_{REF} = 15\text{k}\Omega$, unless otherwise noted.)

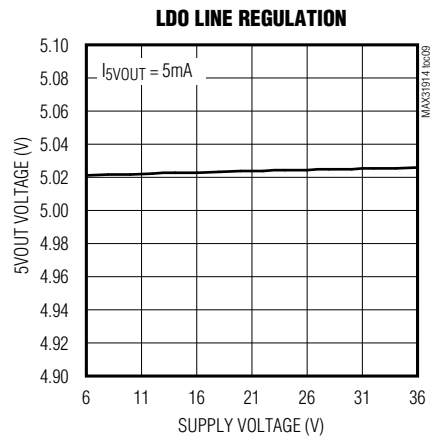
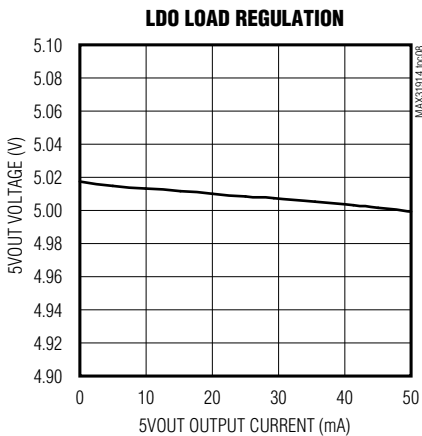
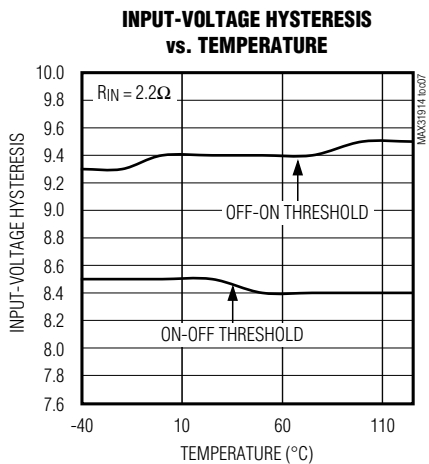
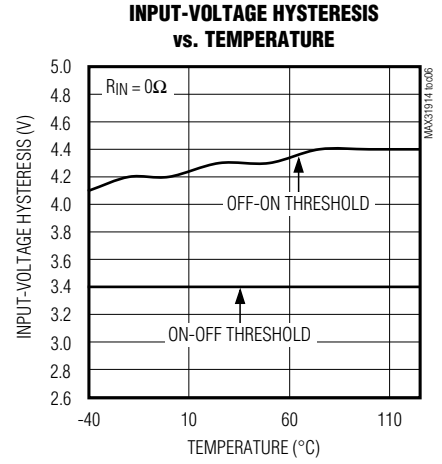
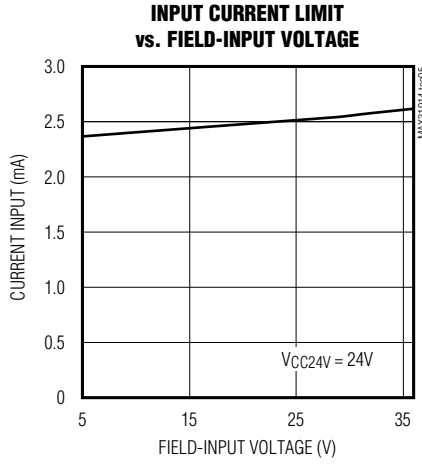
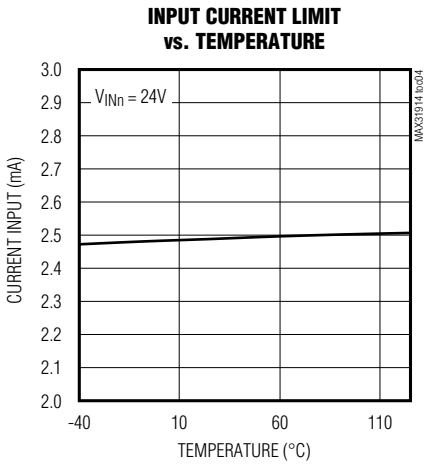
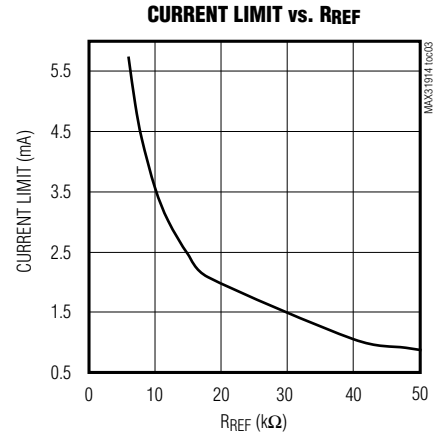
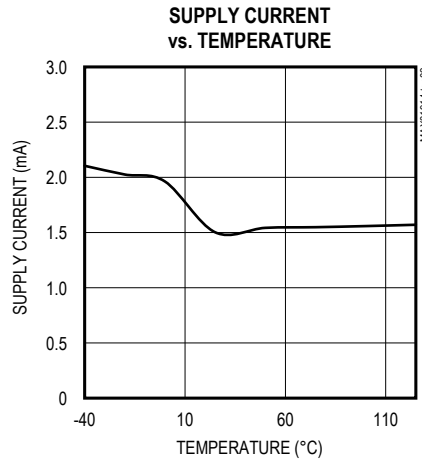
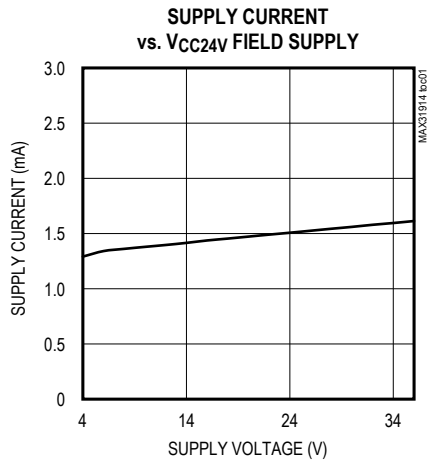

Typical Operating Characteristics (continued)

($T_A = +25^\circ\text{C}$, $R_{REF} = 15\text{k}\Omega$, unless otherwise noted.)

LDO LINE REGULATION

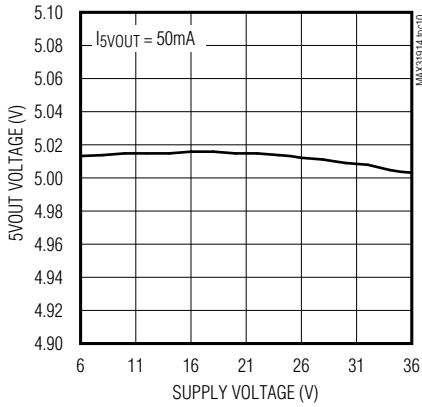

LDO OUTPUT vs. VCC24V FIELD SUPPLY

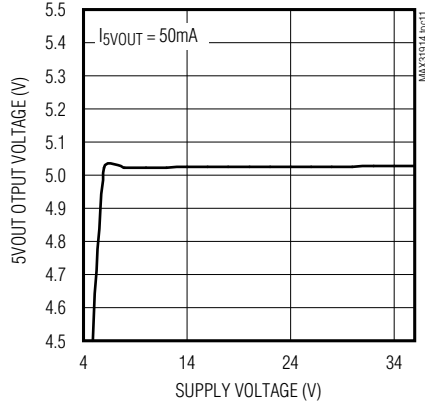

LDO OUTPUT VOLTAGE vs. TEMPERATURE

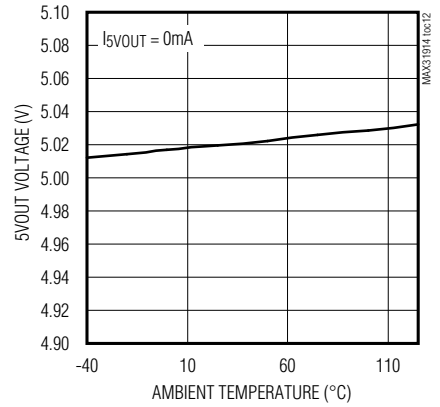

LDO OUTPUT VOLTAGE vs. TEMPERATURE

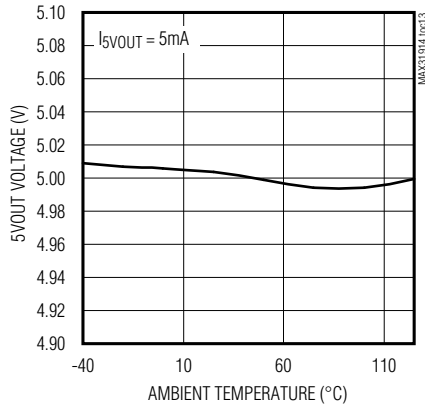

CURRENT LIMIT vs. FIELD INPUT VOLTAGE

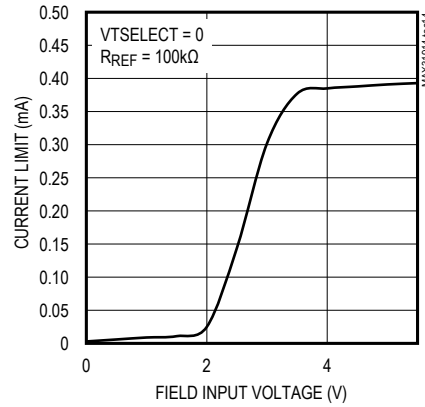

OUTPUT RISE/FALL TIME vs. TEMPERATURE

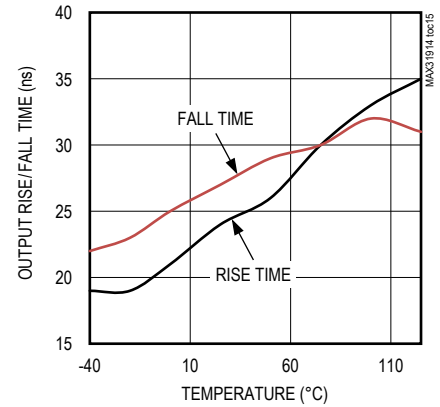

PROPAGATION DELAY vs. TEMPERATURE (FIELD INPUT VOLTAGE = 18V)

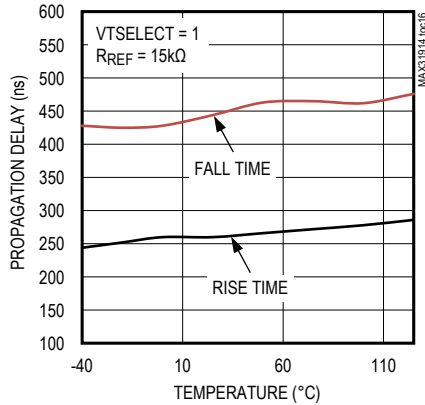

PROPAGATION DELAY vs. TEMPERATURE (FIELD INPUT VOLTAGE = 4.5V)

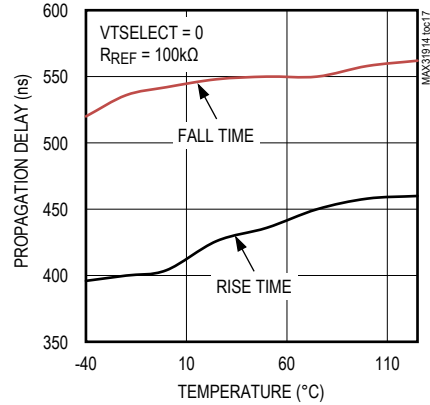

Pin Configuration

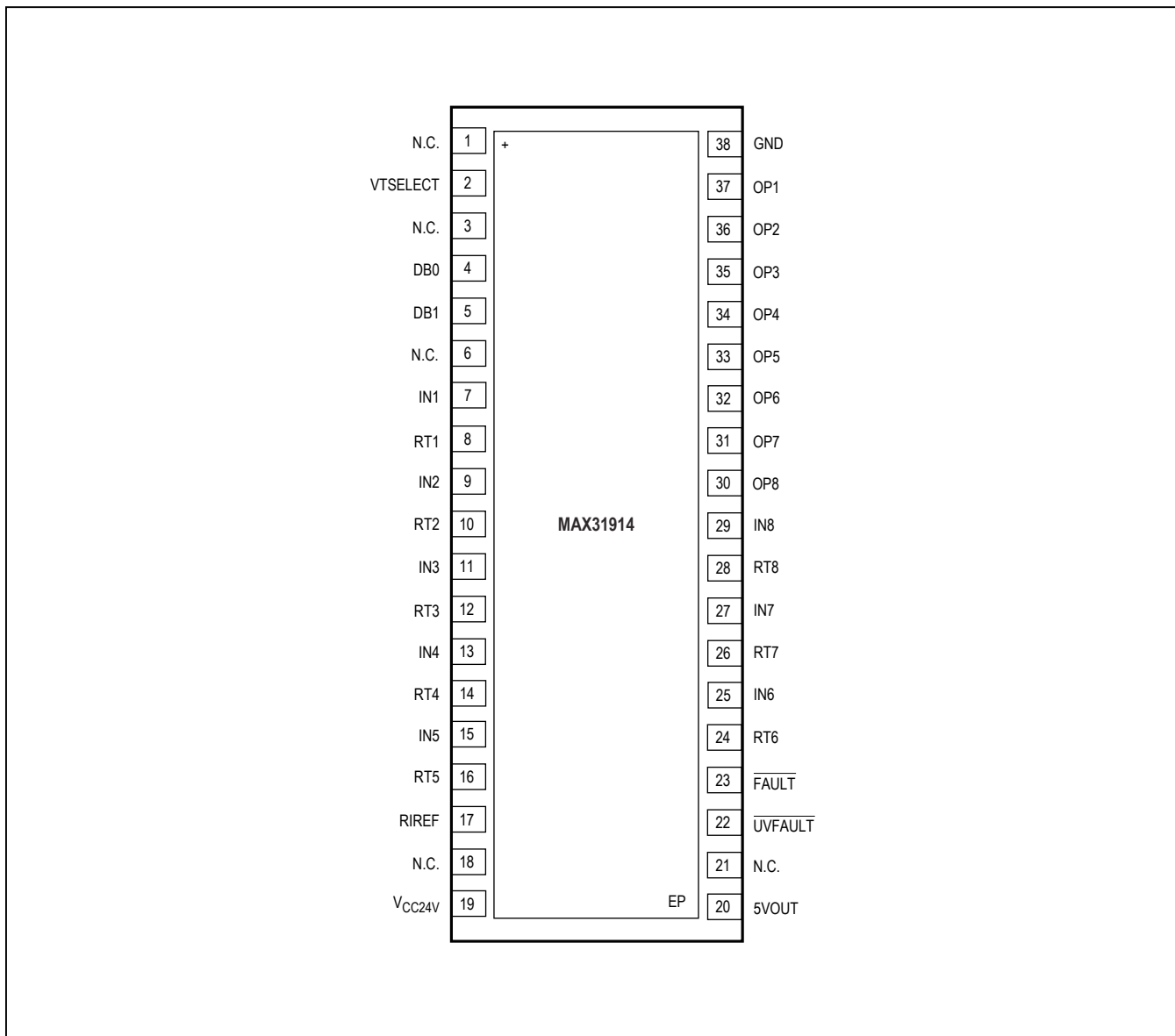

Pin Description

PIN	NAME	FUNCTION		
1, 3, 6, 18, 21	N.C.	No Connection		
2	VTSELECT	Selects input trip points to be CMOS or IEC 61131-2 compliant. Logic 0 = CMOS compliant Logic 1 = IEC 61131-2 compliant		
4	DB0	Debounce (Filtering) Time Select Inputs. These inputs also determine the current switching frequency. See also Table 1 for details.		
5	DB1	DB1	DB0	TIME CONSTANT OF FILTER APPLIED
		0	0	0 (no filtering)
		0	1	0.025ms
		1	0	0.75ms
1	1	3ms		
7, 9, 11, 13, 15, 25, 27, 29	IN1–IN8	Field Input n. IN1 is pin 7 and IN8 is pin 29.		
8, 10, 12, 14, 16, 24, 26, 28	RT1–RT8	Energyless LED Driver Outputs. Connect to GND if LEDs are not required. RT1 is pin 8 and RT8 is pin 28.		
17	RIREF	Current-Limiter Reference Resistor		
19	VCC24V	Field-Supply Voltage		
20	5VOUT	5V Regulator Output		
22	$\overline{\text{UVFAULT}}$	Indicates Low Supply Voltage Alarm (Active Low)		
23	$\overline{\text{FAULT}}$	Indicates Hot Temperature Alarm. This is OR'ed with the $\overline{\text{UVFAULT}}$ indicator (active low).		
30–37	OP8–OP1	Logic Output n. OP1 is pin 37. OP8 is pin 30.		
38	GND	Field Ground		
—	EP	Exposed Pad. Must connect EP to the PCB ground plane.		

Detailed Description

Principles of Operation

Input Current Clamp

The input pins (IN1–IN8) sense the state (on versus off) of field sensors by monitoring both the voltage and the current flowing through the sensor output. The current sinking through these input pins rises linearly with input voltage until the limit set by the current clamp is reached. Any voltage increase beyond this point does not increase the input current any further.

The value of the current clamp is adjustable through an external resistor connected between pin RIREF and ground. The voltage at the input pins (IN1–IN8) are compared against internally set references to determine if the sensor is on (logic 1) or off (logic 0). The trip points determining the on/off status of the sensor can be selected through pin VTSELECT as follows:

- VTSELECT = 1 selects trip points that satisfy the requirements of IEC 61131-2 type 1, type 2, and type 3 switches.
- VTSELECT = logic 0 selects trip points that are CMOS logic compatible and roughly centered approximately 2.5V.

Pins RT1–RT8 must be connected directly to GND to provide a return path for the input current if LEDs are not required for visual indication. If VTSELECT = logic 0, RT1–RT8 must be connected directly to GND. If visual indication is needed when VTSELECT = logic 0, then LEDs can be connected to pins OP1–OP8 through external current-limiting resistors.

Glitch Filter

A digital glitch filter provides debouncing and filtering of the noisy sensor signals. The time constant of this filter is selectable between 0 (i.e., no filtering), 25 μ s, 0.75ms, and 3ms. The selection is achieved through pins DB0 and DB1. The

filtered outputs of the comparators are presented to the logic output pins, OP1–OP8.

To provide the digital glitch filter, the device checks that an input is stable for at least three clock cycles. The duration of a clock cycle is 1/3 of the selected debounce time. If the input is not stable for at least three clock cycles, the input change is not sent to the internal shift register. See [Table 1](#) for current-switching settings.

Low-Power Current Clamp Switching

The MAX31914 uses a switched current limiter to reduce power consumption below what is achievable by current limiting alone. The internal filter clock is used to switch input current between 100% and 20% of the chosen current limit. For example, if the current limit is set to 2.4mA, the input current will switch between 2.4mA and 0.48mA. The filter clock switches input current at a

50% duty cycle. The clock period for current switching is automatically selected by the DB1 and DB0 glitch filter settings. See [Table 1](#) for current-switching settings.

Temperature Monitoring

The internal junction temperature of the IC is constantly monitored and an alarm is raised, by asserting the $\overline{\text{FAULT}}$ pin, if the temperature rises above T_{ALRM} .

Supply Voltage Monitoring

A primary supply voltage-monitor circuit constantly monitors the field-supply voltage. If this voltage falls below a threshold (V_{OFFUVLO}), an alarm is raised by asserting the $\overline{\text{FAULT}}$ and $\overline{\text{UVFAULT}}$ pins, indicating to the microcontroller that the part is experiencing a fault condition and the data is not to be trusted. Once the field-supply voltage has recovered and goes above V_{ONUVLO} , the $\overline{\text{FAULT}}$ and $\overline{\text{UVFAULT}}$ pins are released.

Table 1. Debounce/Current Switching Period Settings

DB1	DB0	BINARY VALUE	DEBOUNCE TIME	CURRENT SWITCHING PERIOD
0	0	0	0	DC (disabled)
0	1	1	25µs	8µs
1	0	2	0.75ms	0.25ms
1	1	3	3ms	1ms

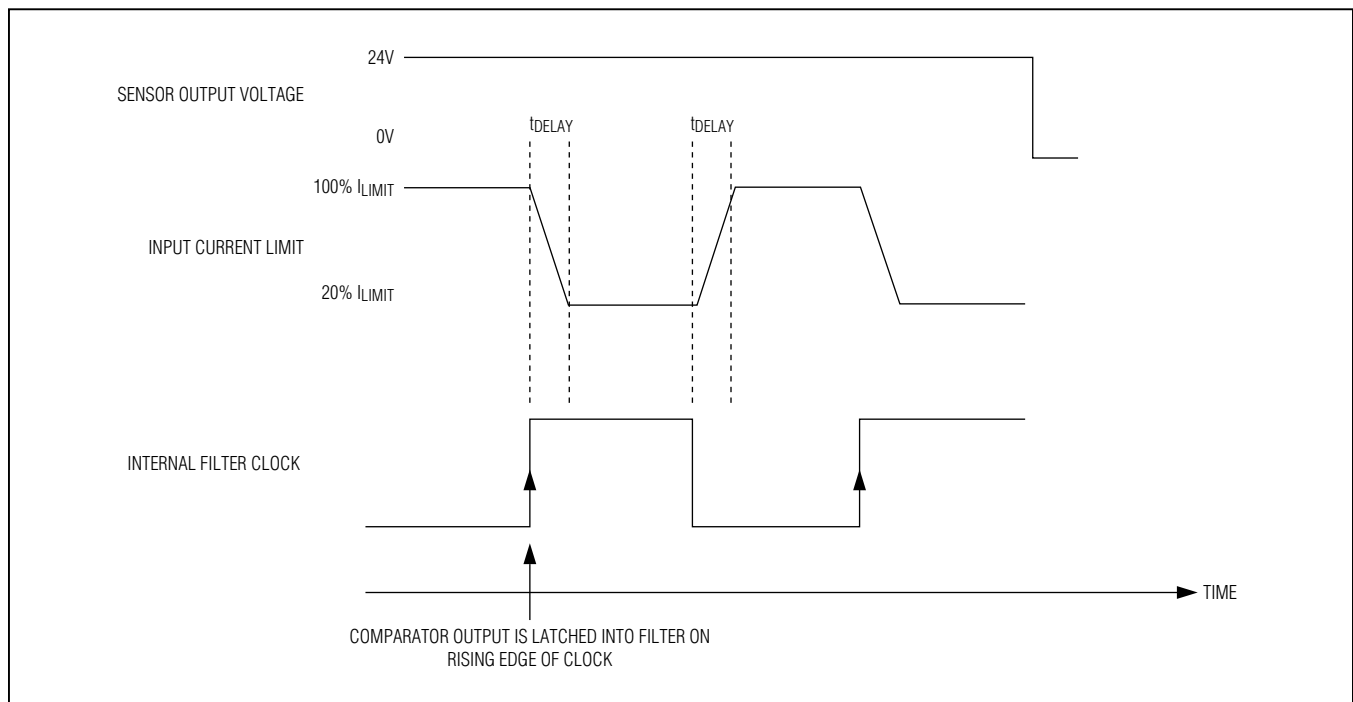

Figure 1. Operation of Switched Current Limiter

Powering the Device Through the 5VOUT Pin

The device can also be powered using a 5V supply connected to the 5VOUT pin. In this case, a 24V supply is no longer needed and the VCC24V supply must be kept unconnected (see [Figure 2](#))

In this configuration, the device will always indicate a UVFAULT and the FAULT pin will always be active (pulled low). Faults due to the Supply Voltage monitoring and Temperature Monitoring will not be available.

This configuration has lower power consumption and heat dissipation since the on-chip 5V voltage regulator is disabled.

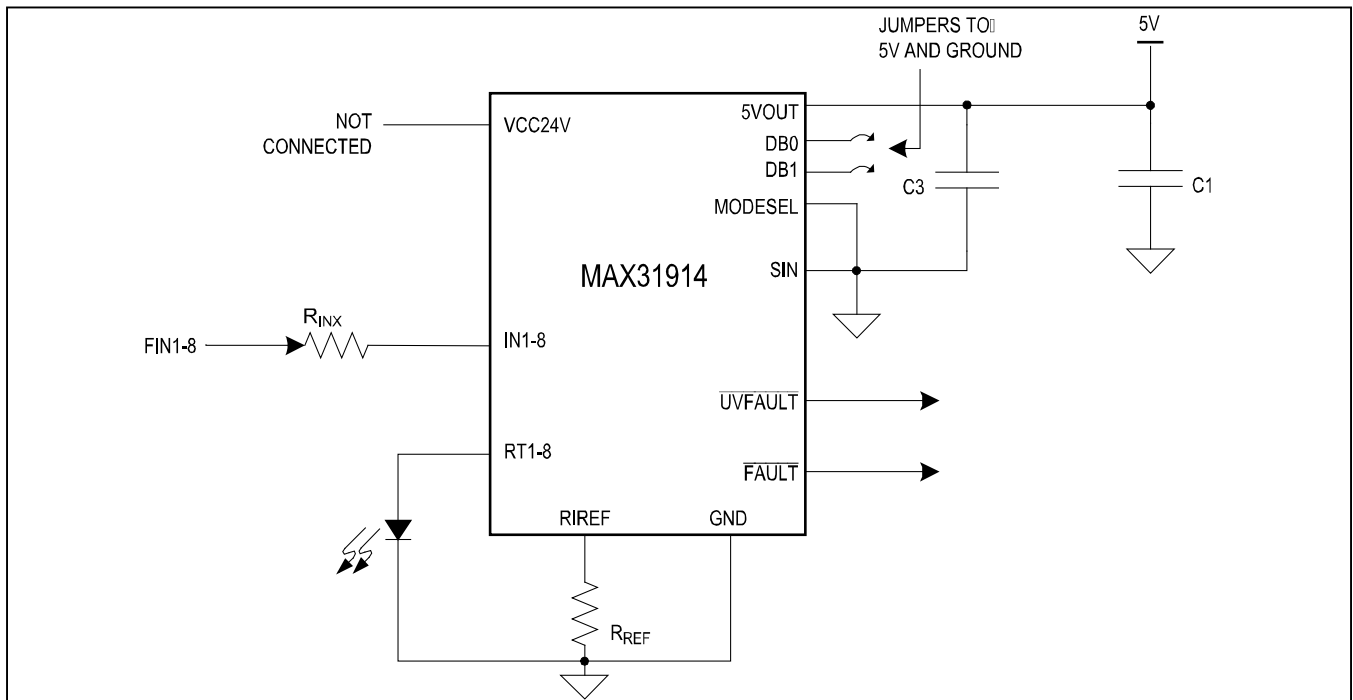

Figure 2. Basic Application Powered Through 5VOUT

Typical Application Circuit

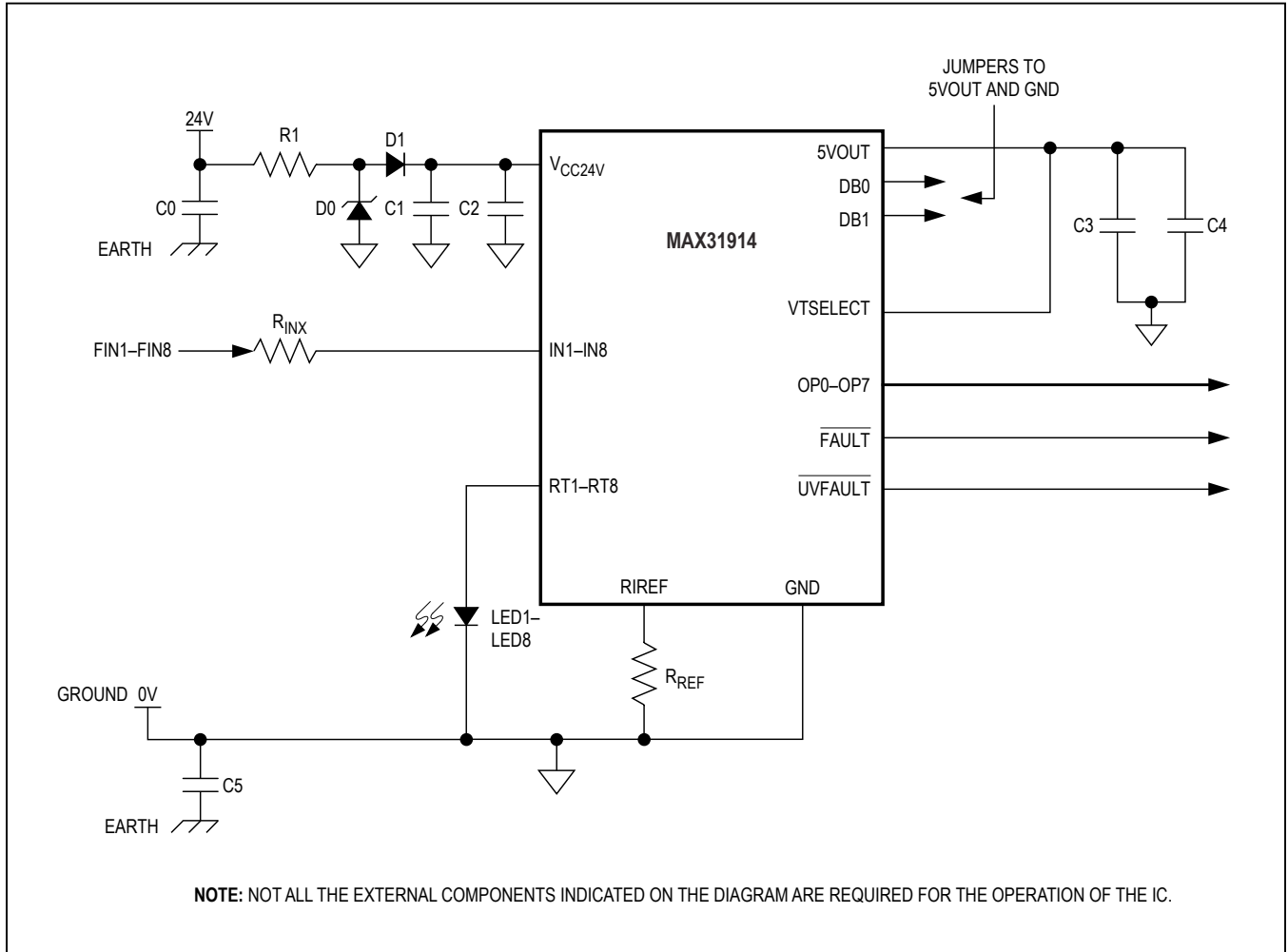

Table 2. Recommended Components

COMPONENT	DESCRIPTION	REQUIRED/RECOMMENDED/OPTIONAL
C0, C5	4.7nF, 2kV polypropylene capacitor	Recommended
C1	10μF, 60V ceramic capacitor	Required
C2	100nF, 60V ceramic capacitor	Required
C3	100nF, 10V ceramic capacitor	Recommended
C4	4.7μF, 10V low-ESR ceramic capacitor	Required
D0	36V fast zener diode (ZSMB36)	Recommended
D1	General-purpose rectifier (IN4007)	Optional: For reverse-polarity protection.
LED1–LED8	LEDs for visual input status indication	Optional
R1	150Ω, 1/3W MELF resistor	Required
R _{INX}	2.2kΩ, 1/4W MELF resistor	Required
R _{REF}	15kΩ, 1/8W resistor	Required

Note: For higher EFT EMC performance, a minimum 1nF, 1000V capacitor can be added from nodes FIN1–FIN8 to earth ground or ground. For additional methods to improve EFT robustness, please check the Maxim website regularly for upcoming application notes currently being developed.

Ordering Information

PART	TEMP RANGE	PIN-PACKAGE	CARRIER
MAX31914AUI+	-40°C to +125°C	38 TSSOP	Bulk
MAX31914AUI+T	-40°C to +125°C	38 TSSOP	Tape and Reel

+Denotes a lead(Pb)-free/RoHS-compliant package.
T = Tape and reel.

Chip Information

PROCESS: BiCMOS

Package Information

For the latest package outline information and land patterns (footprints), go to www.maximintegrated.com/packages. Note that a “+”, “#”, or “-” in the package code indicates RoHS status only. Package drawings may show a different suffix character, but the drawing pertains to the package regardless of RoHS status.

PACKAGE TYPE	PACKAGE CODE	OUTLINE NO.	LAND PATTERN NO.
38 TSSOP	U38E+3	21-0714	90-0435

Revision History

REVISION NUMBER	REVISION DATE	DESCRIPTION	PAGES CHANGED
0	12/14	Initial release	—
1	4/15	Fixed IEC diagram and added 5VOUT description.	11–13

For pricing, delivery, and ordering information, please contact Maxim Direct at 1-888-629-4642, or visit Maxim Integrated's website at www.maximintegrated.com.

Maxim Integrated cannot assume responsibility for use of any circuitry other than circuitry entirely embodied in a Maxim Integrated product. No circuit patent licenses are implied. Maxim Integrated reserves the right to change the circuitry and specifications without notice at any time. The parametric values (min and max limits) shown in the Electrical Characteristics table are guaranteed. Other parametric values quoted in this data sheet are provided for guidance.