

# IRG5410 Cellular LTE Routers

 [perle.com/products/routers-gateways/irg5410-cellular-lte-routers.shtml](https://perle.com/products/routers-gateways/irg5410-cellular-lte-routers.shtml)

## Enterprise-Class Edge Cellular Routers & Gateways

- LTE Router for Primary or Failover Connectivity
- Out of band management for remote troubleshooting
- LTE-Advanced (LTE-A and LTE-A Pro) for 10x faster downlink speeds and 3x faster uplink speeds
- Rugged, Compact, Industrial-grade form factor (IP54)
- Network connectivity via LTE, 10/100/1000 Ethernet, USB 3.2, and RS232 Serial
- Enhanced Security with Two-Factor Authentication (2FA)



**Perle IRG5410 LTE Routers and Gateways** have the most comprehensive set of features, functionality, and performance to provide **primary or failover back-up connectivity** to remote infrastructure and assets. These ultra-low-power, rugged, high-performance Cellular Routers, with dual-SIM slots, are easily deployed with no need for training because of the intuitive web GUI. For advanced admin scripts, CLI commands are also available.

Perle IRG5410 LTE Routers provide fast and reliable network connectivity where wired options are impossible to deploy or require a backup. This is crucial for enabling a wide range of applications while ensuring the highest degree of security to protect the integrity of critical services. Reduce the cost of downtime and service calls, and bringing distributed sites online faster. With support for **Data, SMS, Voice, and Video**, an IRG5410 can be integrated into any enterprise cloud, building, industrial, or mobile location network infrastructure.

- Building and process automation controllers, Internet of Things (IoT)
- Smart grid assets (meters, switches, controllers), Telco infrastructure controllers
- SCADA, Distribution management systems, Remote data loggers, flow meters, sensing equipment
- Digital signage, ATMs, POS, Kiosks, Temporary "pop-up" stores
- Video surveillance, Mobile hotspots
- Fleet management, GPS/GNSS Location tracking, Taxis, vehicle area networking (VAN)
- Transit systems, Buses, Metro Subways, Railways



## Cellular Band Operation Certified Worldwide over 4G LTE, DC-HSPA+, HSPA+, HSPA, and UMTS (WCDMA)

---

Perle IRG5410 Routers and Gateways have two cellular options to ensure **support for your carrier's primary bands** in deployment areas:

1. **IRG5410+**: LTE-A PRO CAT12. 600Mbps downlink and 150Mbps uplink speeds. Support for 24x LTE Bands and 9x UMTS/WCDMA Bands
2. **IRG5410**: LTE-A CAT6. 300Mbps downlink and 50Mbps uplink speeds. Support for 15x LTE Bands and 6x UMTS/WCDMA Bands

## Edge Routers with Enterprise-Grade Routing Capabilities

---

IRG5410 routers have all the of the advance routing functionality found in the most advanced enterprise routers. **Extensive protocol routing support** means they can be easily deployed in hierarchical or large mesh network structures. A fast CPU and lots of memory ensure the router can handle a consistent and heavy workload all day long.

- RIP, RIPv2, RIPng, OSPFv1/2/3, BGP-4
- When BGP peering with multiple ISPs, the IRG5410 delivers carrier-grade routing performance that is capable of handling the full internet routing table
- IPv4 & IPv6
- OpenVPN & IPsec VPN
- DHCP & DHCPv6
- IP Passthrough for deployments requiring the router to operate in Gateway or Bridge mode
- Route between any interface (LTE, Ethernet, USB, or serial RS232)
- Reduce unwanted network traffic by creating collision and/or broadcast domains

## Integrated Zone-Based Policy Firewall

---

The IRG5410 built-in firewall offers intuitive policies for multiple-interface routers to **protect inside networks from unauthorized access** by users on an outside network. The firewall also protects inside networks from each other, for example, by keeping a human resources network separate from a user network. If there are network resources that need to be available to an outside user, such as a web or FTP server, these resources can be placed on a separate network behind the firewall, in a demilitarized zone (DMZ). The firewall will allow limited access to the DMZ, but because the DMZ only includes the public servers, any attacks there will not affect the inside network. The firewall controls when inside users access outside networks (for example, access to the Internet), by allowing only certain addresses out, by requiring authentication or authorization, or by coordinating with an external URL filtering server. A deny-all (blacklist) policy can be used to prohibit traffic between firewall security zones until an explicit policy is applied to allow desirable traffic. Router ports are assigned to zones and firewall inspection policies are applied to traffic moving between the zones. Firewall inter-zone policies come with considerable flexibility and granularity so that different firewall inspection policies can be applied to the same router port.

## Enhanced Security with 2 Factor Authentication

---

With multiple concurrent VPN sessions and 2 Factor Authentication, Perle IRG5410 LTE Routers enable secure communications to multiple back-end systems.

- Remote authentication (RADIUS, TACACS+) management, integrates with enterprise-grade systems to control access to devices in the field.
- Software image CRC control protects the software upgrade process against unwanted software corruption and malware
- High-speed OpenVPN, IP Security (IPsec), Triple Data Encryption Standard (3DES), and Advanced Encryption Standard (AES) encryption for data privacy over the Internet.
- Intrusion prevention enforces security policies in a large enterprise or service provider networks.

## GPS / Global Navigation Satellite System (GNSS) Included

---

GPS and GNSS (Galileo, Glonass, and Beidou) are included by default in all IRG5410 Routers and Gateways. This enables **real-time location tracking** of remote assets. Also, you can get **real-time network clock updates** in the router, or any attached equipment, for accurate time-stamp usage in time-sensitive applications.

## Cutting-edge design certified for a wide range of deployment scenarios

---

High-performance components and features enable customers to take advantage of broadband network speeds while running **secure concurrent data, voice, and video services**. All IRG5410 routers have **high MTBF rates** because they are developed with certified high-end components to provide superior reliability and uninterrupted operation.

<b>Primary or failover back-up connectivity</b>	Perle is the only company to offer LTE edge routers with all of the enterprise-grade features and protocols needed to be a fully functional primary or failover back-up LTE Router. If the main network connection goes down for any reason, Perle IRG5410 routers provide an always-on, cost-effective redundant connection. The relatively low cost of LTE for branch continuity means a greater return on investment and scalability for multiple locations. Simply put, an IRG5410 LTE Router ensures maximum uptime, cost-effective scalability, and ease of deployment and management with limited IT resources.
---	--

---

---

**Compact  
light-weight  
design**

Deploy in many different environments where space, heat dissipation, and low power consumption are critical factors. The optional DIN-Rail mounting brackets or wall-mount brackets ensure easy installation.



---

**Ultra-Low-  
Power**

IRG5410 Routers are designed to operate on limited power sources by consuming less than 1 Watt in idle mode. This makes them ideal for battery and solar applications. In addition, Standby Mode can be used to protect power sources by dropping power consumption to a target of 53 mW. This can be triggered by timers, low voltage detection, or I/O. IRG5410 routers also work with the existing power infrastructure in 2G/3G deployments that are migrating to LTE thus, eliminating the need to invest in replacement equipment.

---

**Rugged  
Environment  
Certifications**

- Rugged die-cast aluminum IP54 enclosure for dust & water ingress
- Shock and vibration resistance certified to MIL-STD-810G, SAE J1455 & EN 61373
- Hazloc per IECEx/IECx, ATEX, & ANSI/ISA Class 1 Div 2
- -40°C to +70°C operating temperature

---

**Vehicle  
Deployment**

- Cellular tower connectivity can be established and maintained at up to 100 meters per second (360km/224mi per hour)
  - E-Mark Certification, ISO 7637-2, and ISO 16750-2 Compliance
  - Built-in battery charge protection, with no requirement for external power conditioning, to safeguard vehicle operation
  - Vehicle awareness applications can be used to remotely monitor vehicle speed, acceleration, position, and more.
  - Ignition Power Management can schedule a delayed shutdown or startup of the IRG5410 based on the vehicle ignition status
-

---

**Railway Deployment** Perle IRG5410 LTE Routers and Gateways are fully approved and certified for Railway rolling stock application deployments. They are perfectly suited for installation directly in the train or subway cabin, the dusty and humid environments of metro tunnels or, the enclosures found alongside rail tracks.

- European Certifications EN50155 & EN50121
- International Certifications IEC60571 & IEC62236
- Cellular tower connectivity can be established and maintained at up to 100 meters per second (360km/224mi per hour)

## Dual-SIM LTE Failover for true Business Continuity

---

Perle IRG5410 Routers and Gateways come with redundant SIM slots to ensure reliable network connectivity and cellular multihoming support in LTE and HSPA-based networks. This is particularly useful:

- When the primary carrier contract data cap has been exceeded, the IRG5410 will automatically switch over to a back-up data plan.
- When the IRG5410 is deployed in a mobile environment long-distance roaming can be enabled and used.
- When there is a lack of coverage, or carrier network failure, the IRG5410 will automatically switch over to a back-up carrier.

## More Features and Benefits

---

WAN Connectivity      LTE and 10/100/1000 Ethernet

---

Central Management Configuration      Perle IRG5410 Routers and Gateways use **PerleView**, a web-based server configuration tool that simplifies setup and deployment. Centralized management capabilities give network managers visibility and control over network configurations at remote sites. Other Perle IRG5410 management capabilities include:

- Fast Setup - Available when the router is in factory default (initial) configuration
  - Web Manager - Available using a browser
  - CLI - Command Line Interface
  - SNMP - Using a Network Management System
  - **No ongoing monthly or yearly licensing fees**
- 
-

---

Serial Port      Perle IRG5410 routers come with an IOLAN Secure Device Server built-in for a secure serial to IP (Ethernet/LTE) connectivity applications. This makes it ideal for applications that require remote device console management, data capture, or monitoring. Some of the supported applications are:

- TrueSerial® packet technology delivers the most authentic serial connections across Ethernet for serial protocol integrity.
- Serial Port Access: connect directly using Telnet / SSH
- Terminal Server: Telnet, SSH, Rlogin, LPD, RCP printer
- Serial machine to IP (Ethernet)
- Raw serial data over Ethernet/LTE/TCP/IP/UDP
- Virtual modem simulation
- TruePort redirector
- ModBus, DNP3 and IEC-870-5-101 encapsulation
- Line access permissions via TACACS+ and RADIUS servers
- Dial direct serial: PPP, PAP/CHAP, SLIP

## Software Feature Set: IRG5410 Cellular LTE Routers

---

All features and functionality are included in the base price of the product. There are no additional costs or fees.

### Functionality

---

Gateway (IP Passthrough Bridging), Switching, Routing

---

### Routing Protocols

---

IPv4/IPv6, Static Routing, RIP/RIPNg, NAT, OSPFv3, BGP-4, IPv6 Encapsulations (GRE, 6in4), Port Routing

---

### IP Applications

---

DDNS, DNS Proxy / Spoofing, relay, client, Opt. 82,

---

NTP & SNTP (versions 1, 2, 3, 4) with support from GPS, GNSS & Network Carrier timing

---

DHCP / DHCPv6 server & BOOTP for automated network-based setup

---

### VLAN & VPN

---

VLAN, IPSec, OpenVPN, VPN Failover (16 concurrent VPN tunnels)

---

### GPS & GNSS Reports

---

---

GPS for tracking equipment over RS232, USB, and Ethernet

---

NMEA 0183 v3.0, TAIP, CSV

---

## **Firewall & Security**

---

Built in Zone-Based Policy Firewall

---

Access Control Lists (list & ranges & time)

---

Filter based on MAC Address, IP, Port, Protocol, User

---

AAA, Radius, TACACS+

---

802.1x

---

Certificate Support (X.509)

---

Port Forwarding

---

BGP Communities

---

## **Security Features**

---

Security via remote authentication (Radius and TACACS+)

---

Trusted host filtering (IP filtering), allowing only those hosts that have been configured in the host table access to the router.

---

Idle LTE port timers, which close a connection that has not been active for a specified period of time

---

Ability to disable services (for example, Telnet, TruePort, Syslog, SNMP, Modbus, HTTP) for additional security

---

Ability to individually disable network services that won't be used by the SSH client/server connections (SSH 1 and SSH 2)

---

Logging via syslog

---

Ability to disable Ping responses

---

Ability to setup Access Lists (ACL's) to restrict traffic

---

Ability to set up firewalls to restrict incoming and outgoing packets

---

SSH client/server connections (SSH 1 and SSH 2)

---

---

SSL/TLS client/server data encryption (TLSv1/1.1/1.2 and SSLv2)

---

Ability to setup Virtual Private Networks (VPNs)

---

Wireless Security; WEP, WPA2-PSK & Enterprise (EAP, PEAP, LEAP), 802.11i

---

Wireless cellular security using PAP or CHAP authentication

---

Dynamic DNS with DYNDNS.org

---

Domain Name Server (DNS) support

---

Email alert notification

---

SSH connections (supported ciphers are Blowfish, 3DES, AES-CBC, AES-CTR, AES-GCM, CAST, Arcfour and ChaCha20-Poly1305)

---

SSL/TLS connections

---

RIP authentication (via password or MD5)

---

OSPF

---

2F Authentication

---

Management Access Control

---

SNMPv3

---

DMZ

---

FIPS 140-2

---

Secure HTTP/HTTPS/FTP/Telnet Authentication Proxy

---

### **Logging, Reporting & Alerts**

---

Sys Log, Event Type, Report Type, Alerts & Monitoring, Triggers Status Screen Report, Data Usage, Diagnostic

---

### **Management**

---

PerleVIEW Management, WEB (HTTP/HTTPS), SNMPv1/v2/v3, SMS Control, Load Balancing, CLI, Login Banner, E-mail, Ping, Telnet, FTP, Connection on Demand

---

Automatic check for software updates.

---



---

Software updates available over FTP, HTTP, HTTPS, SCP, SFTP, and TFTP

---

### **Power Management (General)**

---

Power Processor Saving Mode – this feature optimizes idle power consumption, saving energy by reducing performance where possible.

---

Power Saving Features including; LED power saving mode, Smart Standby Mode, Power saving strategies such as turning off unused interfaces (USB, Serial, Ethernet), turning off GPS and adjusting the Ethernet rate.

---

#### Operating Power Modes

- Standard – When power is applied to the router, it will power up. All inputs are ignored (from a power up and Smart Standby perspective). This is the default.
  - Smart Standby Mode – you can configure a combination of one or two user defined conditions to determine when the router is powered up and when it goes into Smart Standby Mode.
- 

### **Power Management (Ignition Sense)**

---

Configurable time delay for shutdown / start based on vehicle ignition status

---

Low Voltage Standby function to prevent battery drain

---

Operating Power Mode (Ignition mode) – this mode monitors the ignition input and goes in and out of Smart Standby based on the voltage of the ignition input. When the voltage on the ignition input goes below a user pre-defined threshold, the router will be powered down into Smart Standby Mode. When the voltage on the ignition input goes above the Perle Wireless LTE Router pre-defined value the power will be restored. You can configure a combination of inputs and schedule to control Smart Standby Mode.

---

### **GPIO Capabilities**

---

One GPIO configurable as high side pull-up / dry contact, analog input, digital input, low side current sink output, digital output/open drain, or Pulse Counter.

---

One GPIO configurable as Vehicle ignition sense or analog input

---

### **Serial Port Capabilities**

---

Access: connect directly using Telnet / SSH

---

Terminal Server: Telnet, SSH v1 and v2, Rlogin, Auto session login, LPD, RCP printer

---

Serial to Ethernet: Tunnel raw serial data across Ethernet - clear or encrypted, RAW serial data over TCP/IP/UDP, packetized data, virtual modem, TruePort com/tty redirector, TrueSerial packet technology, RFC2217 transport & RS232 control signals

Industrial Protocols Encapsulations: ModBus, DNP3 and IEC-870-5-101, ModBus TCP Gateway

Remote Access: PPP, PAP/CHAP, SLIP

## Hardware Specifications: IRG5410 Cellular LTE Routers

Products can be purchased with or without antennas and with or without power cords. All functionality is included in the base price of the product. Additional accessories are sold separately.

	<b>IRG5410</b>	<b>IRG5410+</b>
<b>Cellular</b>		
LTE	LTE-A CAT6. 300Mbps downlink and 50Mbps uplink speeds	LTE-A PRO CAT12. 600Mbps downlink and 150Mbps uplink speeds
Frequency Bands	<b>4G/LTE Bands (15)</b> 2100(B1), 1900(B2),	<b>4G/LTE Bands (24)</b> 2100(B1), 1900(B2), 1800(B3), AWS(B4),
Data & SMS	1800(B3), AWS(B4),	850(B5), 2600(B7), 900(B8), 1800(B9),
Operation over 4G	850(B5), 2600(B7), 900(B8),	700(B12), 700(B13), 850(B18), 850(B19),
LTE with fallback	700(B12), 700(B13),	800(B20), 850(B26), 700(B28), 700(B29),
networks DC-	800(B20), 1900(B25),	2300(B30), 1500(B32), TDD B41, TDD B42, TDD
HSPA+ / HSPA+ /	850(B26), 700(B29),	B43, TDD B46, CBRS B48, 1700(B66)
HSPA / UMTS	2300(B30), TDD B41	
(WCDMA)	<b>3G HSPA/HSPA+ Bands (6)</b> 2100(B1), 1900(B2), 1800(B3), AWS(B4), 850(B5), 900(B8)	<b>3G HSPA/HSPA+ Bands (9)</b> 2100(B1), 1900(B2), 1800(B3), AWS(B4), 850(B5), 800(B6), 900(B8), 1700(B9), 850(B19)
	<b>Public Safety Band</b> Band 26	<b>Public Safety Bands</b> Bands 26, 28

---

Cellular Antenna	Frequency Range: 704-902-928-960/1427.9-1575.42/1710-2170/2400-2480-2690MHz Gain: 3 dBi Impedance: 50 ohm Voltage Standing Wave Ratio: <3.0 (typical) Radiation: Omni-Directional Connector: SMA Male (Swivel) Dimensions: 135.6 x 20.1 mm / 5.34 x 0.8 in
------------------	--

---

SIM	Dual Mini-SIM 15 x 25mm (or 2FF )
-----	-----------------------------------

---

### GPS / GNSS

---

GPS / GNSS	Wide-band GNSS: 1559-1606 MHz GPS: 1575.42 MHz / GLONASS: 1602 MHz / BeiDou: 1561.098 MHz / Galileo: 1575.42 MHz / QZSS: 1575.42 MHz Simultaneous tracking: Up to 30 channels Active GNSS antenna support Reports: NMEA 0183 V3.0, TAIP
------------	---

---

GPS / GNSS Passive Antenna	GNSS Applications: GPS, Glonass, Galileo, Beidou Frequency Range: 1561MHz~1606 MHz Gain: 4 dBi (typical) Impedance: 50 Ohm Voltage Standing Wave Ratio: 2.0 (typical) Polarization: RHCP SMA (M) straight Dimensions: 41.9 x 47.3 x 16.3 mm / 1.65 x 1.86 x 0.64 in RG-174 Cable Length: 5 m / 16.4 ft
-------------------------------	--

---

### 10/100/1000 Mbps Ethernet RJ45 Copper

---

Ports	1 x 10/100/1000 Mbps Ethernet RJ45 Copper
-------	---

---

Speed	Software selectable 10/100/1000 Ethernet, Auto Software selectable Half/Full/Auto duplex
-------	---

---

Ethernet Isolation	1.5Kv Magnetic
--------------------	----------------

---

Standards	IEEE 802.3 for 10Base-T, IEEE 802.3u for 100Base-TX and 100Base-FX, IEEE 802.3ab for 1000Base-T, IEEE 802.3x for Flow Control
-----------	---

---

Processing Type	Store and Forward
MAC Address Table Size	8K
VLAN ID range	1 to 4000

### USB

USB-C	1 x USB 3.2 Type-C with a transfer rate up to 5Gbps Configurable for Ethernet over USB
-------	---

### Serial

RS232 Serial	1 x RS232 DB9 female connector Serial Port Speeds: 50bps to 230Kbps with customizable baud rate support Data Bits: 5,6,7,8-bit protocol support Parity: Odd, Even, Mark, Space, None Flow Control: Hardware, Software, Both, None Serial Port Protection: 15Kv Electrostatic Discharge Protection ( ESD ) Processing Type - Store and Forward
--------------	---

### Power Connector

One GPIO Input	Digital Input & Pulse Counting VDC: 0 for $\leq 1V$ , 1 for $\geq 2.7V$ Dry Contact Max Current range: min 0.6mA @ 7V and max 3.5mA @ 36V Current Sink Output: 0.5A @ 12v
Ignition Sense	Analog Input: 0.5V to 36V

### Platform Specifications

Microprocessor	Dual Core ARM 1.2GHz
RAM	1GB DDR4
Flash	4GB MMC
LED Indicators	Power: indicates power status
	Serial: indicates serial RS232 connection status and Tx data
	WWAN: indicates Wireless Wide Area Network status

---

GNSS: indicates Global Navigation Systems for GPS, Galileo, Glonass and Beidou status

---

VPN: indicates VPN presence (for Router Models: IRG5520x & IRG5540x only)

---

Internet: indicates Internet connectivity

---

**Environmental Specifications**

Operating Temperature: -40°C to 70°C / -40°F to 158°F

---

Storage Temperature: -40°C to 85°C / -40°F to 185°F

---

Operating Humidity: 0% to 95% non-condensing

---

Storage Humidity: 0% to 95% non-condensing

---

Operating Altitude: 3048 m / 10,000 ft

---

Cooling: EN 60068-2-1

---

Dry heat: EN 60068-2-2

---

Damp: EN 60068-2-30

---

MTBF: > 287,215 hours (Calculation model based on MIL-HDBK-217-FN2 @ 30°C/86°F)

---

Heat Output (BTU/HR)

---

**Enclosure**

Die Cast Aluminium

---

**Mounting**

Desktop / Panel / wall-mount  
DIN Rail attachment bracket is optional.  
(Mounts to standard 35 mm DIN rail in accordance with DIN EN 60175 vertically or horizontally)

---

**Ingress Protection Rating**

IP54

---

**Power**

**Power Input**

12/24 VDC Nominal (7 to 36 VDC Range)

---

**Ignition Sense**

VDC voltage variation with On/Off and timer

---

**External Power Supply (optional)**

110 / 220 VAC Power supply with support for EU, US/CND, UK, AUS

---

Power Connector



Router connection

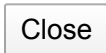
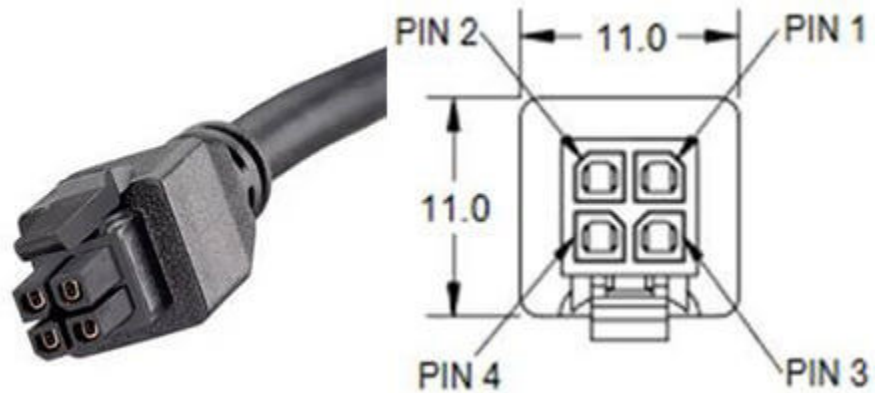

Max Power/Current Consumption

Ignition Off (all power is switched off, but Vin connected): xxmW / xx mA  
Standby Mode (CPU and radio are off, with GPIO sense on): xxmW / xx mA  
On Mode (CPU and Radio are on with no traffic):  

1. Typical Idle (no Wi-Fi): xxmW / xx mA
2. Max (no Wi-Fi): xxmW / xx mA
3. Inrush Current (no Wi-Fi): xxA @ 12 VDC averaged over 100 micro seconds

Power Line Protection

Surge: 8KV (EN61000-4-5 common mode), 2KV (EN61000-4-5 differential and common modes)

Reverse polarity protection

YES

Vehicle Transient voltage protection

Built-in protection against voltage transient including 5 VDC engine cranking and +200 VDC load dump

### Weight & Dimensions

Product Weight & Dimensions

Weight: 0.35kg / 0.77lbs

Dimensions: 120 x 85 x 34 mm / 4.72 x 3.34 x 1.33 in

---

Shipping Weight & Dimensions	Weight (with Antenna):0.78kg / 1.72lbs Weight (without Antenna): 0.55kg / 1.21lbs
------------------------------	--

---

Dimensions: 270 x 170 x 70 mm / 10.63 x 6.70 x 2.75 in

---

### Regulatory Approvals

---

Shock & Vibration	SAE J1455 (Vibration: Section 4.10.4.1 and 4.10.4.2 Cab Mount, Shock: Section 4.11.3.4 Operational Shock)
-------------------	---

---

MIL-STD-810G (Shock: test method 516.6. Operational Vibration: test method 514.6)

---

EN 61373 (Shock, Vibration long-life / functional-random)

---

Hazloc	IECEX/IECx, ATEX Class 1 Zone 2, Directive 2014/34/EU
--------	---

---

ANSI/ISA 12.12.01, Class 1 Division 2 Groups A-D, ISA 12.12.01-2015

---

Vehical Usage	E-Mark (UN ECE Regulation 10.04, ISO 7637-2:2011 and ISO 16750-2:2012 )
---------------	---

---

Velocity	< 100m/s
----------	----------

---

Railway	EN 50155: 2017 Clause 4.3.6
---------	-----------------------------

---

EN 50121-1: 2017

---

EN 50121-3-2: 2016

---

EN 50121-4: 2016

---

IEC 60571:2012 For Clause 12.2.8 & 12.2.9

---

IEC 62236-1: 2018

---

IEC 62236-3-2: 2008

---

IEC 62236-4: 2018

---

Emissions	FCC 47 Part 15 Subpart B, Class B
-----------	-----------------------------------

---

ICES-003 Issue 6 Class B (Canada)

---

FCC Part 15.247 Subpart C ( 2.4 Ghz)

---

FCC Part 15.407 Subpart E ( 5 Ghz)

---

---

ANSI C63.4 Class B (Radio-Noise Emissions from Low-Voltage Electrical and Electronic Equipment in the Range of 9 kHz to 40 GHz)

---

EN61000-3-2: 2014 (Limits for Harmonic Current Emissions)

---

EN61000-3-3: 2013 (Limits of Voltage Fluctuations and Flicker)

---

CISPR 32:2015/EN 55032:2015 Class B (Electromagnetic compatibility of multimedia equipment - Emission requirements)

---

Immunity

CISPR 25:2016/EN55025: (Vehicles, boats and internal combustion engines - RDC)

---

CISPR 35:2016/EN 55035:2017 (IR)

---

EN 61000-4-2:2009 (ESD)  
+/-2 kV, +/-4 kV, +/-6 kV, +/-8 kV (Contact)  
+/-15 kV (Air)  
Operating mode: powered on

---

EN 61000-4-3: 2006 + A1:2007 + A2:2010(RS)

---

EN 61000-4-4:2012 (EFT) 2 KV (Criteria A)

---

EN 61000-4-5:2014+AMD1:2017 (Surge) 2KV (line to earth), 1.5KV (line to line)

---

EN 61000-4-6: 2013 (CS)

---

EN 61000-4-8: 2009 (PFMF)

---

EN 61000-4-9: 2016 (PMF)

---

EN 61000-4-11: 2004 + A1:2017

---

EN 61000-4-16

---

EN 61000-6-4: 2007 + A1: 2011

---

ISO 7637-2:2004

---

Electrical Safety

UL 61010-1 and UL 61010-2-201, IEC 61010-1:2010+AMD1:2016, IEC 61010-2-201:2017 (includes CB)

---

UL/ULC/EN 62368-1, IEC 62368-1:2018 (includes CB)

---

CAN/CSA C22.2 No. 62368-1-14, IEC 62368-1:2018

---



Cellular / WWAN Radio Standards	EN 300 328 (V2.1.1:2019), ETSI EN 300 328 V2.1.1 (2016-11) (Electromagnetic compatibility)
	EN 301 893 (V1.8.1:2015), ETSI EN 301 893 V2.1.1 (2017-05) (Radiated spurious emissions)
	EN 301 489-1 (V2.1.1:2017-02), ETSI EN 301 489-1 V2.1.1 (2017-02)
	EN 301 489-17 (V3.2.0:2017-03), ETSI EN 301 489-17 V3.1.1 (2017-02)
	EN 301 489-19 (V2.1.1:2019)
	EN 301 908-1 v11.1.7:2018-12, ETSI EN 301 908-1 V7.1.1 (2015-03) (Radiated emissions RF control and monitoring)
	EN 301 908-2 v11.1.2:2017-08, ETSI EN 301 908-2 V11.1.2 (2017-08) (RF conducted)
	EN 301 908-13 v11.1.2:2017-07, ETSI EN 301 908-13 V11.1.2 (2017-07) (RF Conducted)
	EN 62311:2019, IEC 62311 Ed. 1.0 b:2007 (Human exposure restrictions for radio frequency electromagnetic fields)
Cellular/Telecom Regulatory Approvals	FCC/ICES, RED, PTCRB/CTIA, CE
Carrier Certifications	Verizon, AT&T
Environmental Specifications	Reach, RoHS3 and WEEE Compliant
<b>Other</b>	
ECCN	5A992
HTSUS Number	8517.62.0050
Warranty	2 Years

## **M2M / IoT LTE Connectivity**

Perle IRG5410 LTE Routers offer always-on M2M connectivity that is secure, reliable, cost-effective, and easy to deploy. Featuring an industrial-grade ruggedized housing, Perle IRG5410 Routers are a versatile and compact solution that provides 2G/3G/4G LTE connectivity with built-in GPS capabilities. Perle IRG5410 Routers are ideal for solving wireless connectivity challenges in a variety of vertical markets including video surveillance, digital signage, home security, oil and gas exploration, kiosks, fleet management, smart grid, vehicle diagnostics, telematics and many more.

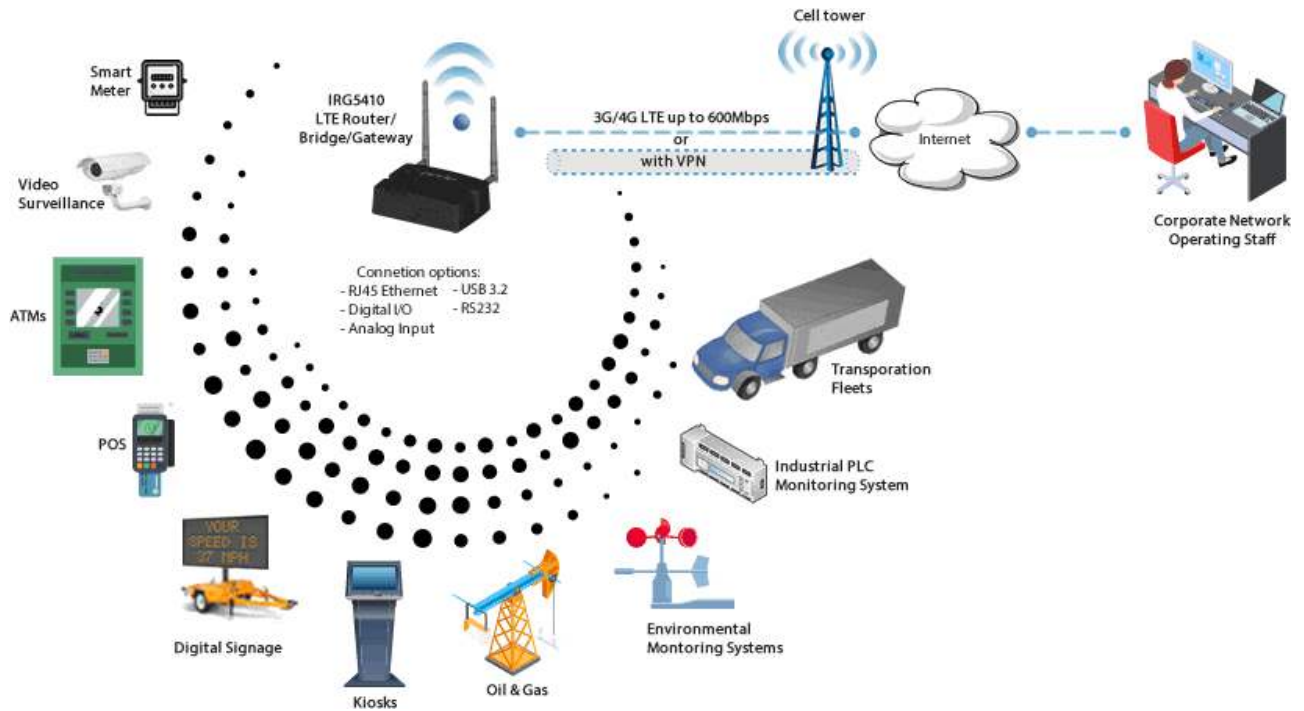

**LTE Failover & Out of Band Management with "Four-Nines" (99.99%Up-time)**

When the wired link is down, network access can be maintained with automatic failover to LTE. There are several ways to determine with the Primary WAN is down. One example, is to use the **Health Monitoring** function where IRG5000 will ping a destination IP through the primary route. If there is no response, the IRG5000 router will initiate a direct connection using the back-up LTE route. The relatively low cost of LTE for business continuity means a greater return on investment and scalability for multiple locations that have limited IT resources. By deploying Perle IRG5000 LTE Routers, businesses will have on-demand network connectivity that is quick to deploy, simple to manage, and ensures maximum uptime.



## Primary Router Deployments

For pop-up stores or branch locations with limited IT resources, the IRG5410 Routers are an easy to deploy solution. This single box will function as an LTE Router and single port 10/100/1000 Ethernet Switch. **IPv4 and IPv6** is supported on both the WAN and LAN sides.

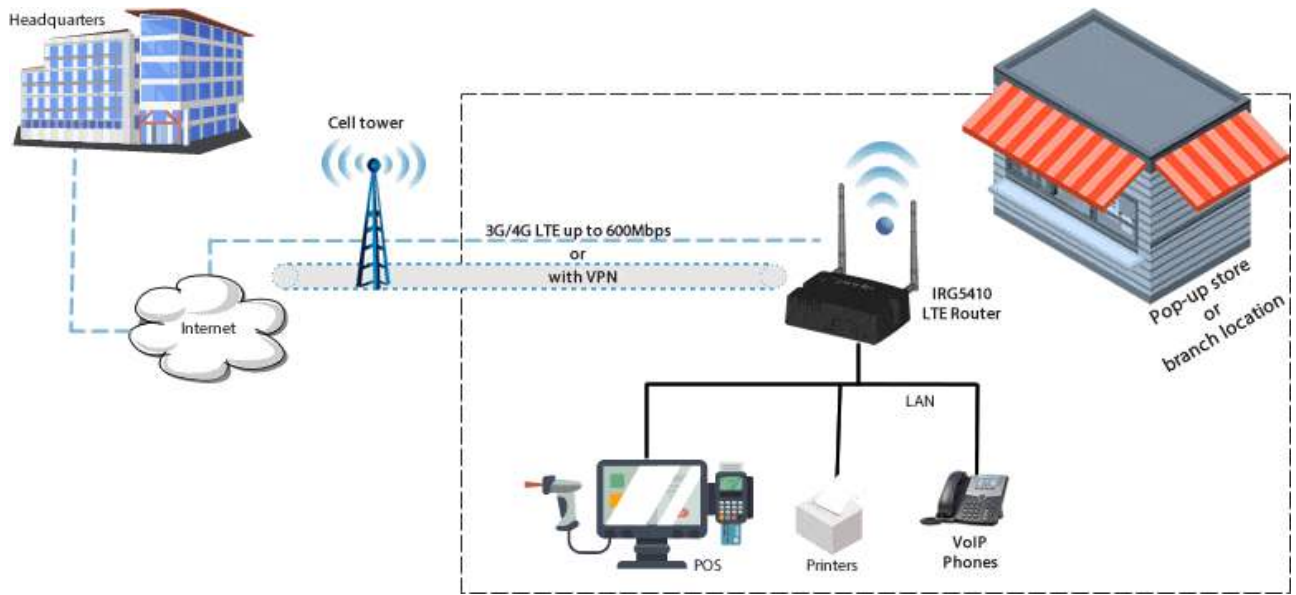

## PCI Compliant LTE Failover

The credit card industry requires retailers to comply with Payment Card Industry (PCI) standard to maintain a secure environment when processing payment card transactions. For these transactions, a Perle IRG5000 Router acts as a wireless data conduit (Gateway) for routers and POS (point-of-sale-terminals) that have been configured for PCI compliance. The USBnet is on a different subnet from the point-of-sale-terminal. All security protocols must be established from the point-of-sale terminal to the payment processor. Payment card terminals must be on a dedicated LAN or VLAN. The Perle IRG5000 Router configured on gateway mode must be connected to a router that is configured for PCI compliance.

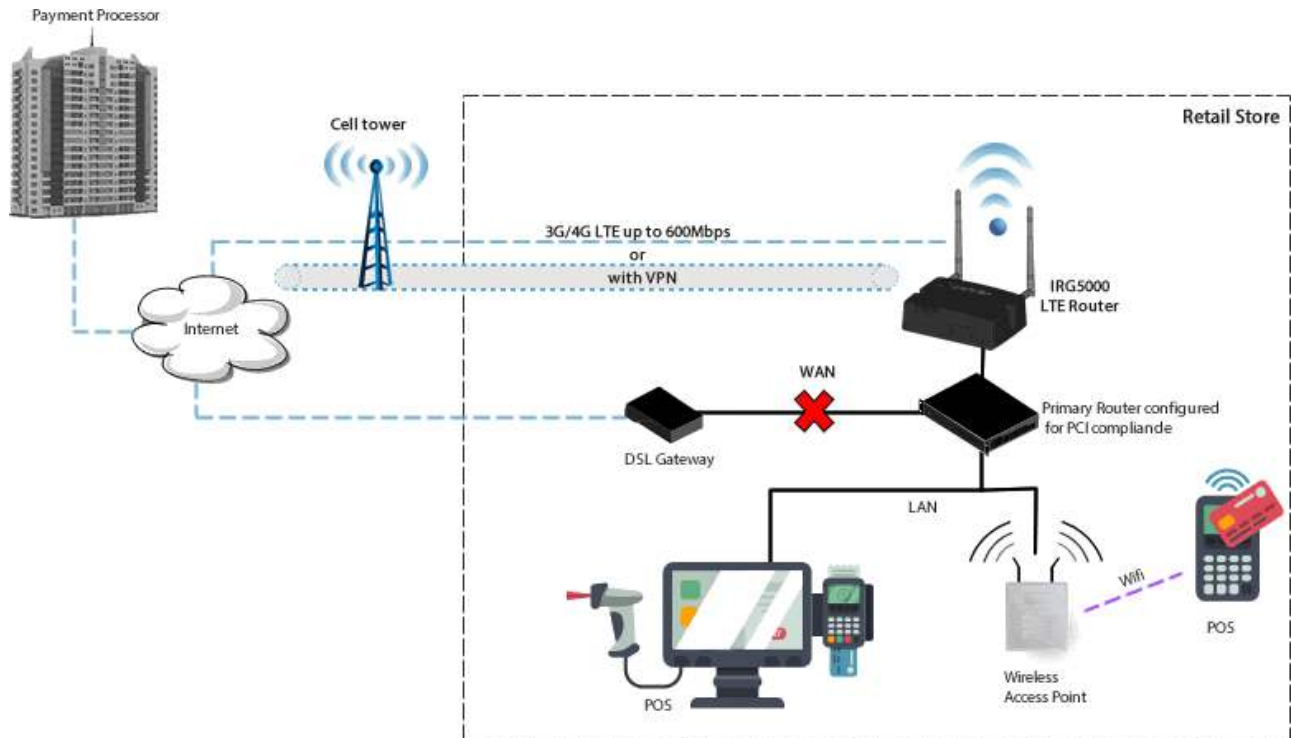

## Communications Gateway for Railway

IRG5410 Routers are compliant with railway regulations and have the operating temperature, vibration, and emission certifications required for installation on trains, light rail, subways, and trams. They are perfectly suited for installation directly in the train or subway cabin, the dusty and humid environments of metro tunnels or, the enclosures found alongside rail tracks. Central administration centers can monitor rail traffic, switching status, track conditions, weather conditions, and security data gathered by the sensors and other equipment located in wayside monitoring stations. Onboard, connecting security cameras, informational displays, and other equipment allows for a wide variety of operational tasks to be undertaken by the control staff. With the ability to establish and maintain cellular tower connectivity at up to 100 meters per second (360km/224mi per hour), the IRG5410 LTE Router is ideal for any rolling stock application.

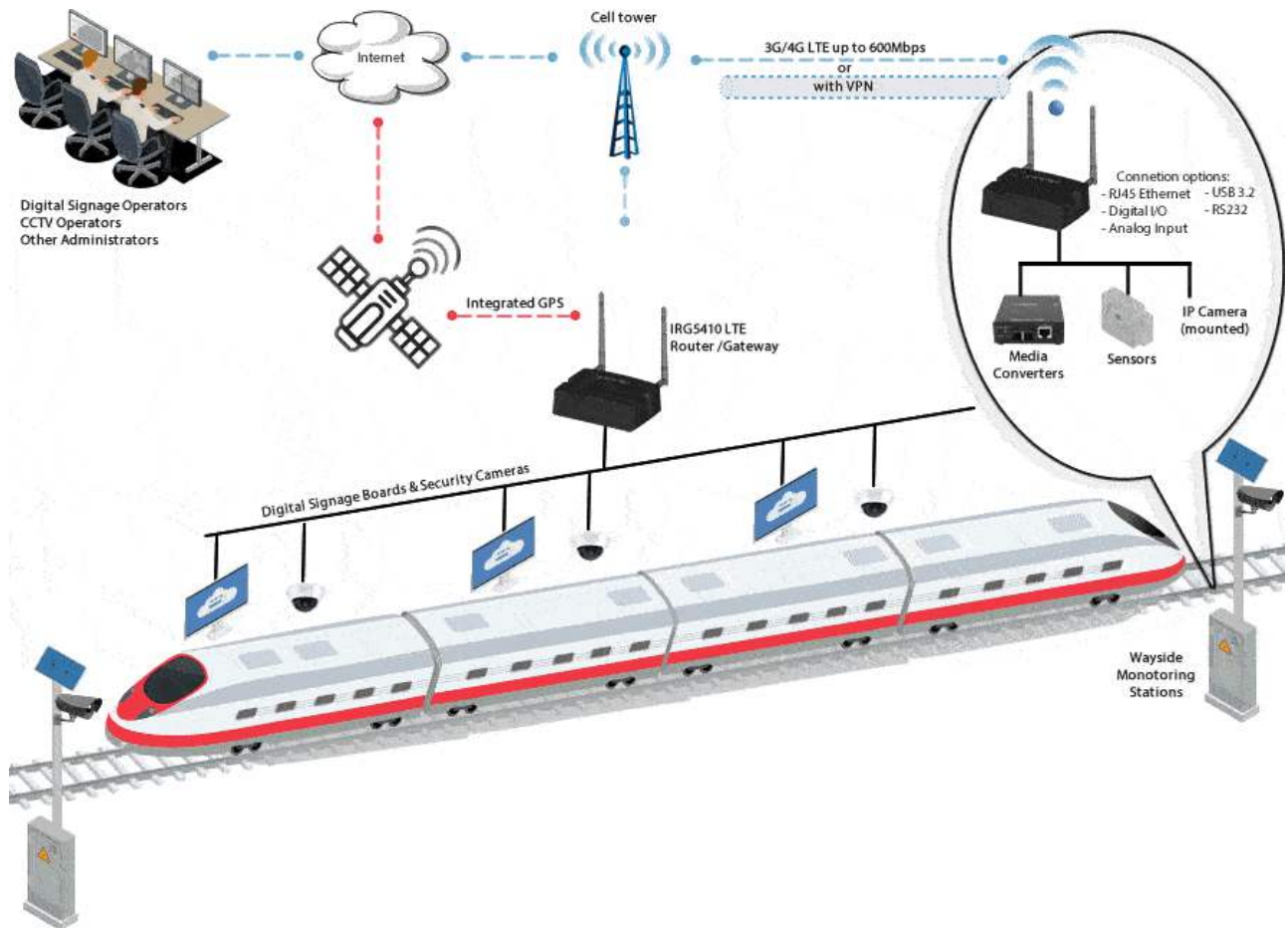

## Failover with Static Routing

Force specified traffic to use different routing rules to direct specified traffic from the IRG5000 Router, or a connected device) to a designated primary router. If the primary route fails the specified traffic uses a backup route.

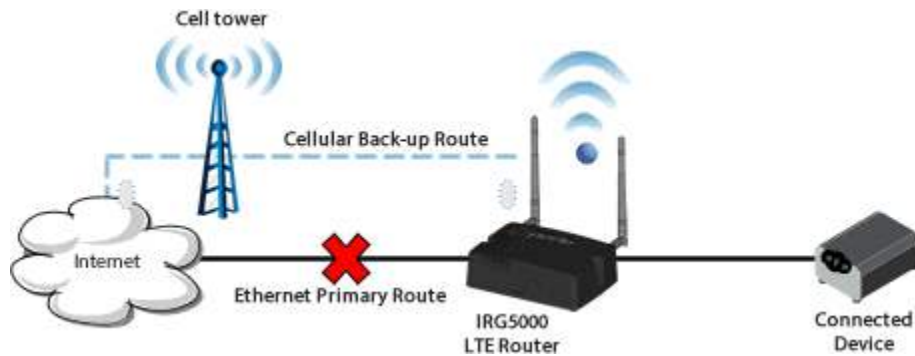

### VPN Failover

With DPD and VPN Failover configured in the IRG5000 Router, two VPN tunnels are configured but only one is active at a time. If DPD detects that the destination is not responding through the Primary VPN, traffic is automatically switched to the Secondary/Backup VPN. The VPN Failover feature will continue to ping the destination through the primary tunnel and, if configured to do so, will automatically revert back to the primary once it is up again. Status fields can be viewed to see the current status of both VPNs.

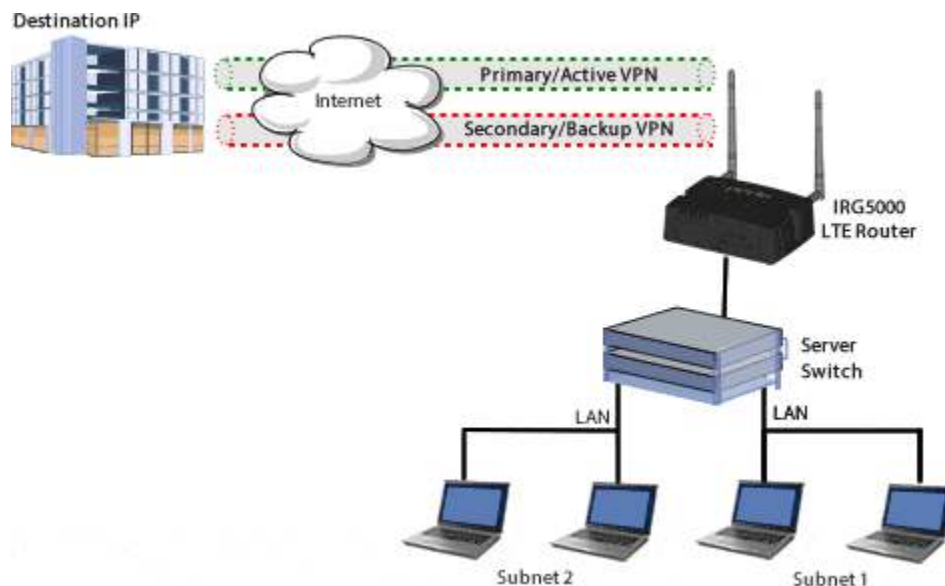

### Non-NATed Networks

---

The Perle IRG5000 Cellular Router can handle multiple non-NATed networks behind a connected router or switch.



---

## VLAN Support

The Perle IRG5000 Router supports up to 4000 VLANs on its Ethernet ports. VLANs are logical groupings of network devices that share the same broadcast domain. All devices on the same VLAN can ping each other without routing. There is no routing between VLANs.

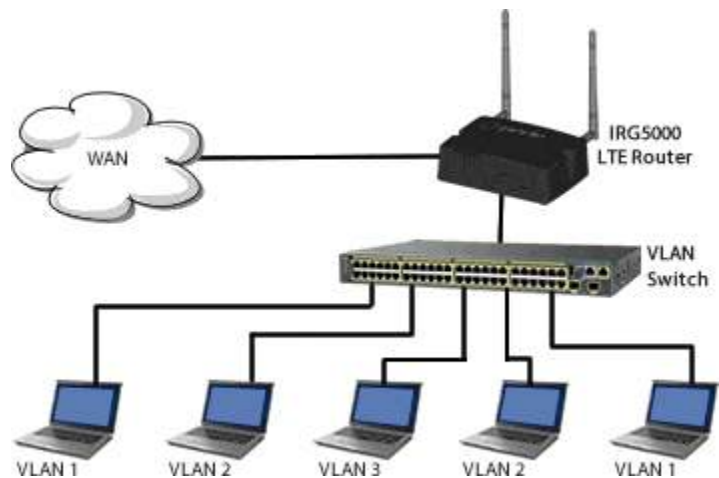

---

## Port Forwarding

---



---

Any unsolicited data coming in on a defined Public Port is routed to the corresponding private port and IP of a host connected on the LAN.



---

### SMS support

The IRG5000 Router accepts SMS commands for basic actions and status. The IRG5000 Cellular Router will send back an acknowledgement that the SMS command was received every time.

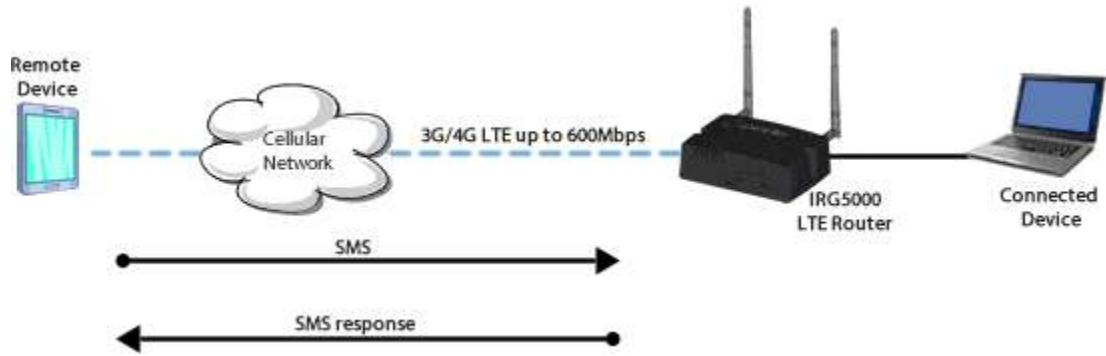

---

### Event Reporting

---

The IRG5410 Router can be configured to generate reports, or initiate actions, based on specified events. These events can be generated internally, or externally by devices attached to the IRG5410 Serial RS232, analog inputs, or digital I/O.

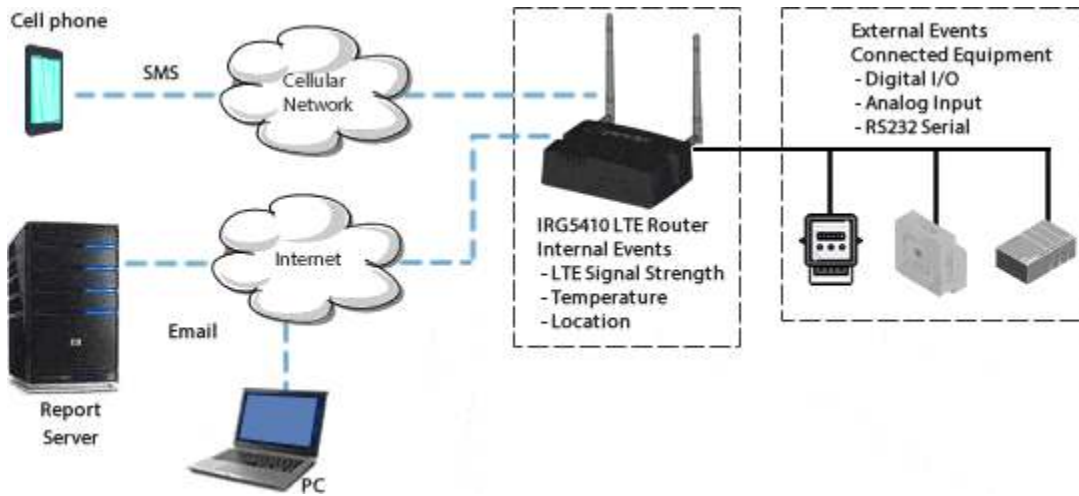

### Serial Gateway

The Serial Port on the IRG5000 Router can be used to establish Serial to IP communications. Connect PLCs, RTUs, Card Readers, or any device with a serial COM port and transmit data over LTE.



### PPP / SLIP / DUN Support

The Perle IRG5000 supports Point-to-Point (PPP) to establish a connection to a host PC serial port. The IRG5000 supports Windows Dial-up Networking when PPP is enabled to establish a connection to a host PC serial port.

