

REVISIONS					
REV	ECO	DESCRIPTION	DATE	BY	APPR
A1	-	RELEASE NEW DRAWING	11APR18	ROOKIE	TOMMY
A2	-	REVISED DESCRIPTION	12JUN19	JAH	DH
A3	-	UPDATE THE APPEARANCE	11NOV21	RONALD	TOMMY

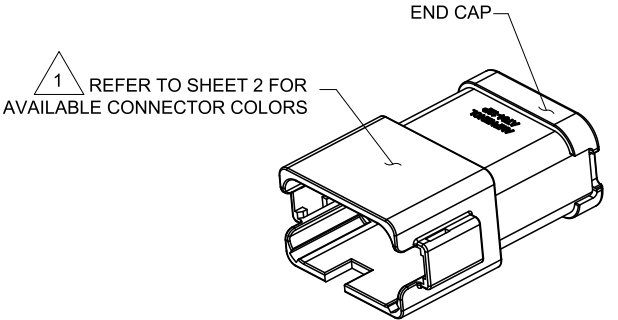
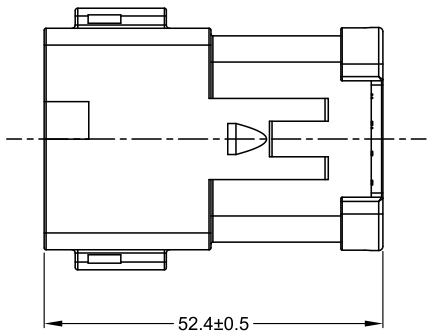
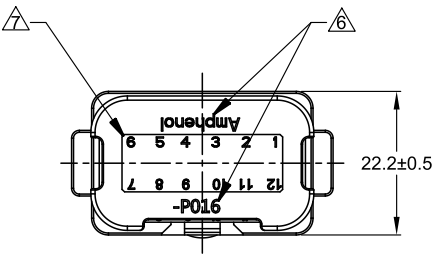
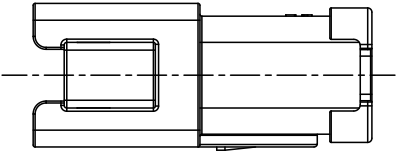
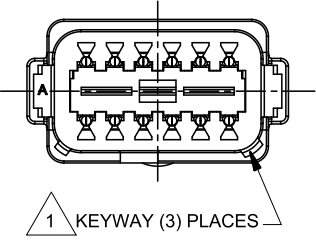
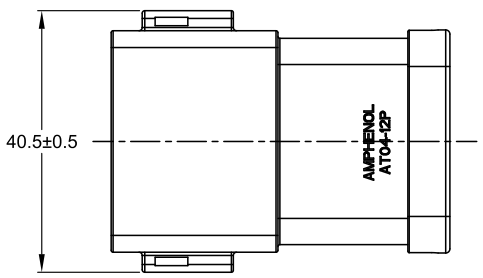

NOTES: UNLESS OTHERWISE SPECIFIED

1 SEE SHEET 2 FOR KEY ARRANGEMENTS AND COLORS.

2. MATERIAL:
HOUSING: THERMOPLASTIC
SEAL: SILICONE RUBBER
CONTACT: COPPER ALLOY

3. MODIFICATIONS: 12 PIN BUSBAR WITH GOLD PLATED

4. SPECIFICATIONS:
4.1 CURRENT RATING: 78 AMPS MAXIMUM FOR THE 12 PIN BUSBAR
4.2 OPERATING TEMPERATURE: -55°C TO +125°C.
4.3 DIELECTRIC WITHSTANDING VOLTAGE: LESS THAN 2 MILLIAMPS CURRENT LEAKAGE @ 1500 VOLTS AC.
4.4 INSULATION RESISTANCE: 1000 MEGOHM MIN @ 25°C.
4.5 MOISTURE RESISTANCE: IP69K & IP68 (1M OF WATER FOR A PERIOD OF 24 HOURS, MATED CONDITION)
4.6 MATING CYCLE DURABILITY: 100 CYCLES
4.7 RoHS COMPLIANT

5. MATING PART: AT06-12SX* PLUG (X=A,B,C,D KEYS * = AVAILABLE MODIFICATIONS)

6 ORIENTATION OF "Amphenol" AND "-P016" TO BE OPTIONAL

7. ALL DIMENSIONS ARE FOR REFERENCE USE ONLY.

SEE SHEET 2		REF: DT04-12PA-P016 & DT04-12PB-P016			
PART NUMBER		DESCRIPTION		ITEM	
MATERIALS LIST					
QUANTITY		SIGNATURES		DATE	
UNLESS OTHERWISE SPECIFIED		DRAWN: RONALD		11NOV21	
1) All dimensions are in metric(mm).		CHECKED: ORION		12NOV21	
2) Tolerances are as follows:		ENGINEER:			
1 PL DEC ±0.30 Fractions ±1/64		APPROVAL: TOMMY		15NOV21	
2 PL DEC ±0.15 Angles ±1°		CUSTOMER:			
3) Note reference = 1		THIS DRAWING IS SUPPLIED FOR INFORMATION ONLY. DESIGN FEATURES, SPECIFICATIONS AND PERFORMANCE DATA SHOWN HEREON ARE THE PROPERTY OF THE AMPHENOL CORPORATION. NO RIGHTS OF REPRODUCTION ARE IMPLIED. ALL DIMENSIONS ARE SUBJECT TO NORMAL MANUFACTURING VARIATIONS.			
MATERIAL SPECIFICATIONS:		WEIGHT: 27.8g			
PROCESS SPECIFICATIONS:		NEXT ASSY:			
SIZE		TYPE		DWG NO:	
B		C-		AT04-12PX-P016	
SCALE: NONE		SHEET 1 OF 2		REVISION A3	

TITLE: HYPERBUSS AT 12WAY RECP 12PIN BUSBAR GOLD-PLATED
DWG NO: AT04-12PX-P016
REV: A3
SH: 1
OF: 2

REVISIONS					
REV	ECO	DESCRIPTION	DATE	BY	APPR
A1	-	RELEASE NEW DRAWING	11APR18	ROOKIE	TOMMY
A2	-	REVISED DESCRIPTION	12JUN19	JAH	DH
A3	-	UPDATE THE APPEARANCE	11NOV21	RONALD	TOMMY

P/N AT04-12PA-P016
KEY-A CONFIGURATION
STANDARD COLOR: GREY

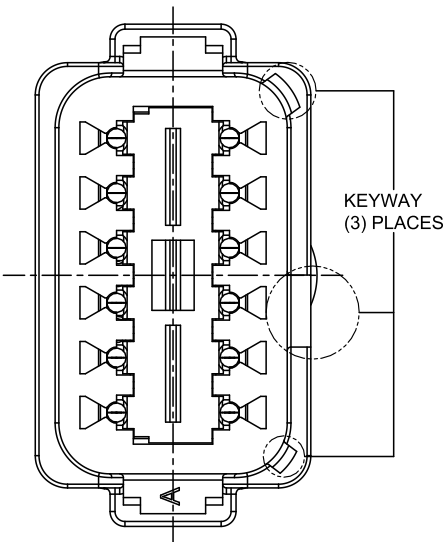

P/N AT04-12PB-P016
KEY-B CONFIGURATION
STANDARD COLOR: BLACK

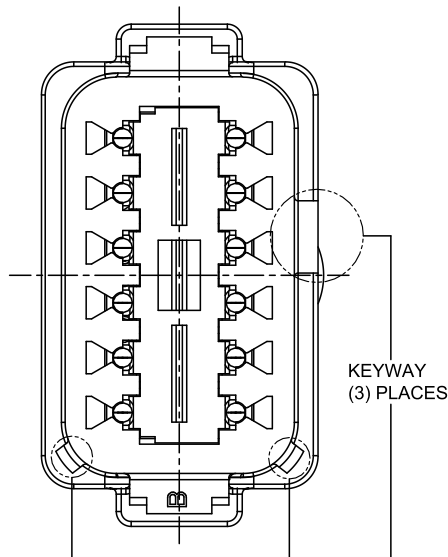

P/N AT04-12PC-P016
KEY-C CONFIGURATION
STANDARD COLOR: GREEN

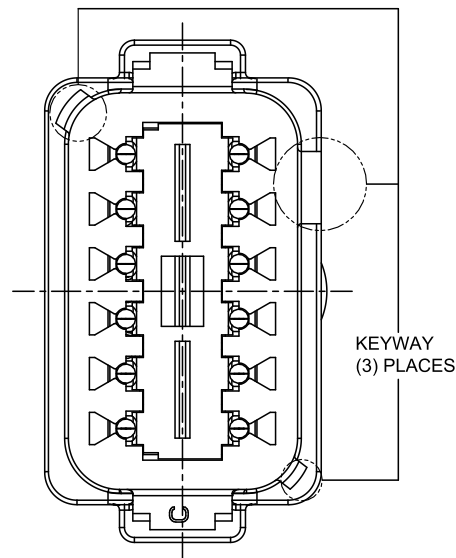

P/N AT04-12PD-P016
KEY-D CONFIGURATION
STANDARD COLOR: BROWN

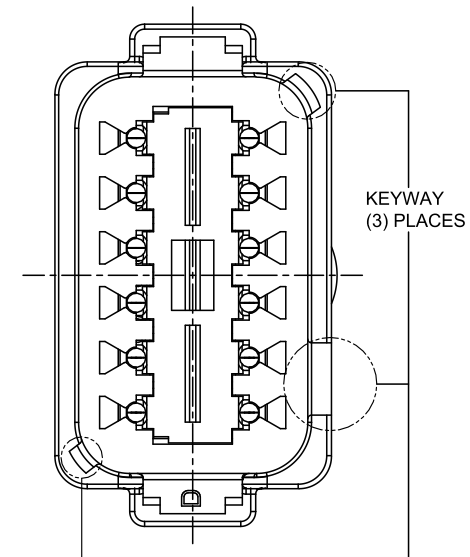

TITLE: HYPERBUSS AT 12WAY RECP 12 PIN BUSBAR GOLD-PLATED
DWG NO: AT04-12PX-P016
REV: A3
SH: 2
OF: 2

QUANTITY	PART NUMBER	DESCRIPTION	ITEM										
MATERIALS LIST													
<small>UNLESS OTHERWISE SPECIFIED</small> 1) All dimensions are in metric(mm). 2) Tolerances are as follows: 1 PL DEC ±0.30 Fractions ±1/64 2 PL DEC ±0.15 Angles ±1° 3 PL DEC ±0.08 3) Note reference =		<table border="1"> <thead> <tr> <th>SIGNATURES</th> <th>DATE</th> </tr> </thead> <tbody> <tr> <td>DRAWN: RONALD</td> <td>11NOV21</td> </tr> <tr> <td>CHECKED: ORION</td> <td>12NOV21</td> </tr> <tr> <td>ENGINEER:</td> <td></td> </tr> <tr> <td>APPROVAL: TOMMY</td> <td>15NOV21</td> </tr> </tbody> </table>		SIGNATURES	DATE	DRAWN: RONALD	11NOV21	CHECKED: ORION	12NOV21	ENGINEER:		APPROVAL: TOMMY	15NOV21
SIGNATURES	DATE												
DRAWN: RONALD	11NOV21												
CHECKED: ORION	12NOV21												
ENGINEER:													
APPROVAL: TOMMY	15NOV21												
MATERIAL SPECIFICATIONS: WEIGHT: 27.8g		<h1>Amphenol</h1> <p>Sine Systems - www.amphenol-sine.com 44724 Morley Drive Clinton Township, MI 48036</p>											
PROCESS SPECIFICATIONS: NEXT ASSY:		CUSTOMER: THIS DRAWING IS SUPPLIED FOR INFORMATION ONLY. DESIGN FEATURES, SPECIFICATIONS AND PERFORMANCE DATA SHOWN HEREON ARE THE PROPERTY OF THE AMPHENOL CORPORATION. NO RIGHTS OF REPRODUCTION ARE IMPLIED. ALL DIMENSIONS ARE SUBJECT TO NORMAL MANUFACTURING VARIATIONS.											
		SIZE: B C- SCALE: NONE	DWG NO: AT04-12PX-P016 REVISION: A3 SHEET 2 OF 2										