

SMD ■ B EAST1616RGBA3

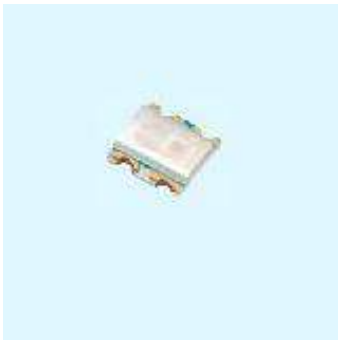

Features

- Package in 8mm tape on 7" diameter reel.
- Compatible with automatic placement equipment.
- Compatible with infrared and vapor phase reflow solder process.
- Multi-color type.
- Pb-free.
- The product itself will remain within RoHS compliant version.
- Compliance with EU REACH.
- Compliance Halogen Free .(Br <900 ppm ,Cl <900 ppm , Br+Cl < 1500 ppm).

Description

- The SMD LED is much smaller than lead frame type components, thus enable smaller board size, higher packing density, reduced storage space and finally smaller equipment to be obtained.
- Besides, lightweight makes them ideal for miniature applications. etc.

Applications

- Backlighting in dashboard and switch.
- Telecommunication: indicator and backlighting in telephone and fax.
- Flat backlight for LCD, switch and symbol.
- General use.

Device Selection Guide

| Code | Chip Materials | Emitted Color | Resin Color |
|------|----------------|-----------------|-------------|
| R6 | AlGaInP | Brilliant Red | |
| GH | InGaN | Brilliant Green | Water Clear |
| BH | InGaN | Blue | |

Absolute Maximum Ratings (Ta=25°C)

| Parameter | Symbol | Code | Rating | Unit |
|---|-----------|------|---|------|
| Reverse Voltage | V_R | | 5 | V |
| Forward Current | I_F | | 25 | mA |
| Peak Forward Current (Duty 1/10 @1KHz) | I_{FP} | R6 | 60 | mA |
| | | GH | 100 | |
| | | BH | 100 | |
| Power Dissipation | P_d | R6 | 60 | mW |
| | | GH | 95 | |
| | | BH | 95 | |
| Electrostatic Discharge(HBM) | ESD | R6 | 2000 | V |
| | | GH | 150 | |
| | | BH | 150 | |
| Operating Temperature | T_{opr} | | -40 ~ +85 | °C |
| Storage Temperature | T_{stg} | | -40 ~ +90 | °C |
| Soldering Temperature | T_{sol} | | Reflow Soldering : 260 °C for 10 sec. Hand Soldering : 350 °C for 3 sec. | |

Electro-Optical Characteristics (Ta=25°C)

| Parameter | Symbol | Code | Min. | Typ. | Max. | Unit | Condition |
|------------------------------|-------------------|------|-------|-------|-------|------|---------------------|
| Luminous Intensity | I _v | R6 | 18.0 | ----- | 57.0 | mcd | I _F =5mA |
| | | GH | 28.5 | ----- | 112 | | |
| | | BH | 11.5 | ----- | 28.5 | | |
| Viewing Angle | 2θ _{1/2} | | ----- | 120 | ----- | Deg | |
| Peak Wavelength | λ _p | R6 | ----- | 632 | ----- | nm | I _F =5mA |
| | | GH | ----- | 518 | ----- | | |
| | | BH | ----- | 468 | ----- | | |
| Dominant Wavelength | λ _d | R6 | 613 | ----- | 627 | nm | I _F =5mA |
| | | GH | 520 | ----- | 530 | | |
| | | BH | 465 | ----- | 475 | | |
| Spectrum Radiation Bandwidth | Δλ | R6 | ----- | 20 | ----- | nm | I _F =5mA |
| | | GH | ----- | 35 | ----- | | |
| | | BH | ----- | 25 | ----- | | |
| Forward Voltage | V _F | R6 | 1.7 | ----- | 2.2 | V | I _F =5mA |
| | | GH | 2.6 | ----- | 3.0 | | |
| | | BH | 2.6 | ----- | 3.0 | | |
| Reverse Current | I _R | R6 | ----- | ----- | 10 | μA | V _R =5V |
| | | GH | ----- | ----- | 50 | | |
| | | BH | ----- | ----- | 50 | | |

Note:

1. Tolerance of Luminous Intensity: ±11%
2. Tolerance of Dominant Wavelength: ±1nm
3. Tolerance of Forward Voltage: ±0.1V

R6

Bin Range of Luminous Intensity

| Bin Code | Min. | Max. | Unit | Condition |
|----------|------|------|------|---------------------|
| M | 18.0 | 28.5 | mcd | I _F =5mA |
| N | 28.5 | 45.0 | | |
| P | 45.0 | 57.0 | | |

GH

Bin Range of Luminous Intensity

| Bin Code | Min. | Max. | Unit | Condition |
|----------|------|------|------|---------------------|
| N | 28.5 | 45.0 | mcd | I _F =5mA |
| P | 45.0 | 72.0 | | |
| Q | 72.0 | 112 | | |

Bin Range Of Forward Voltage

| Bin Code | Min. | Max. | Unit | Condition |
|----------|------|------|------|---------------------|
| 1 | 2.6 | 2.8 | V | I _F =5mA |
| 2 | 2.8 | 3.0 | | |

BH

Bin Range of Luminous Intensity

| Bin Code | Min. | Max. | Unit | Condition |
|----------|------|------|------|---------------------|
| L | 11.5 | 18.0 | mcd | I _F =5mA |
| M | 18.0 | 28.5 | | |

Bin Range Of Forward Voltage

| Bin Code | Min. | Max. | Unit | Condition |
|----------|------|------|------|---------------------|
| 1 | 2.6 | 2.8 | V | I _F =5mA |
| 2 | 2.8 | 3.0 | | |

Note:

1. Tolerance of Luminous Intensity: ±11%
2. Tolerance of Forward Voltage: ±0.1V

Typical Electro-Optical Characteristics Curves

R6

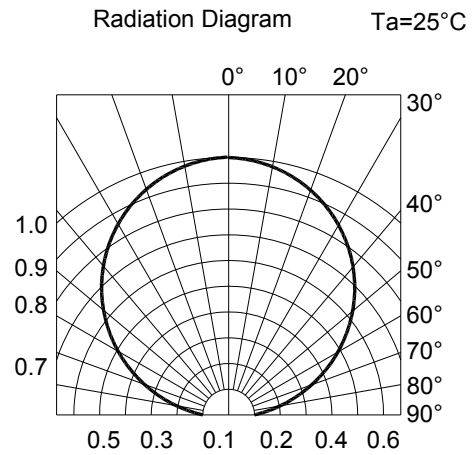
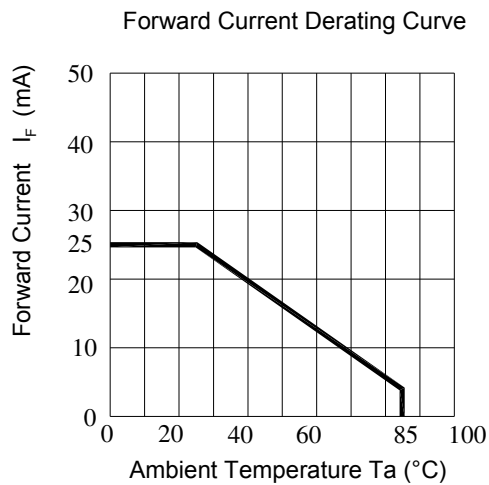
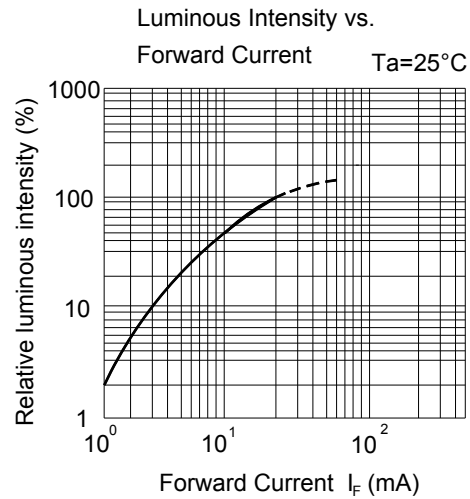
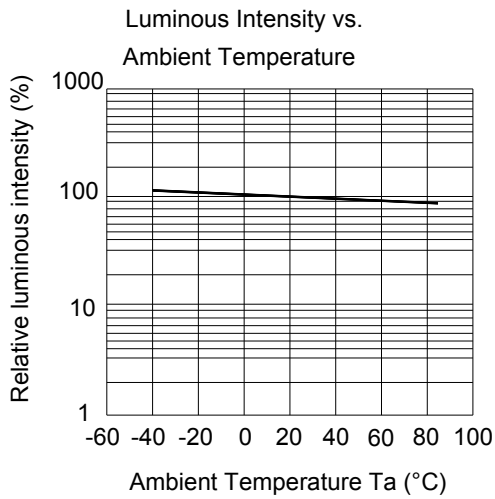
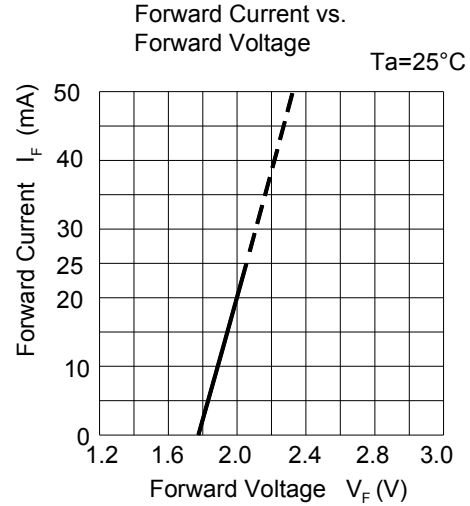
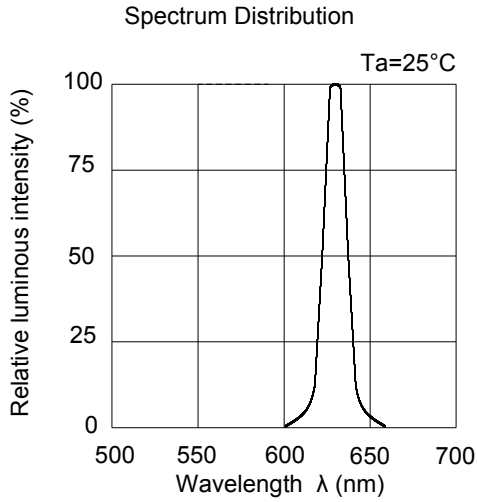

Typical Electro-Optical Characteristics Curves

GH

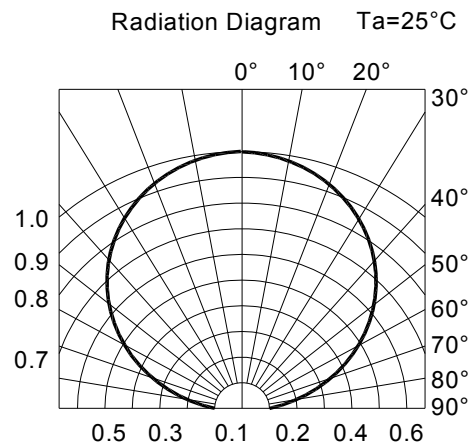
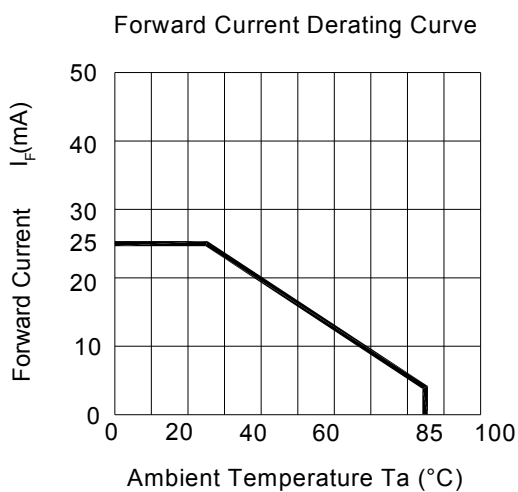
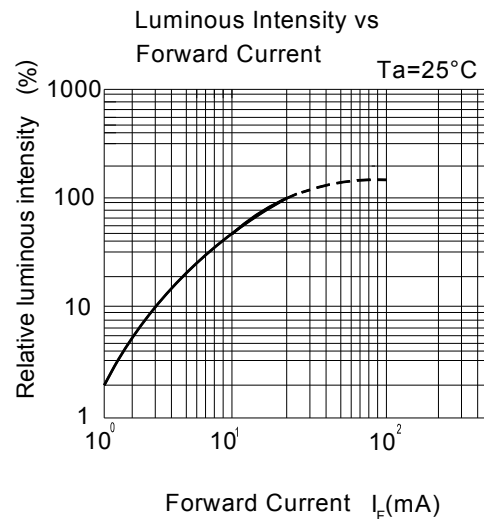
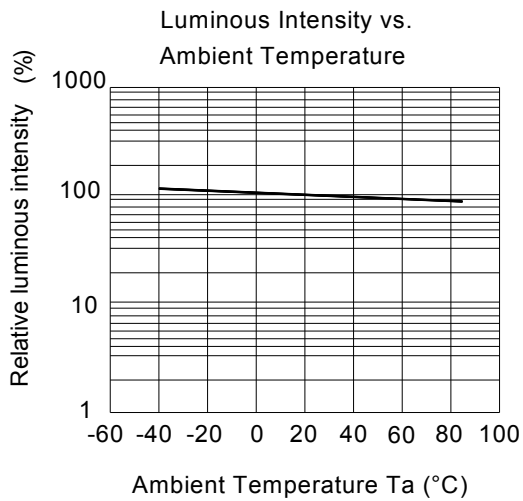
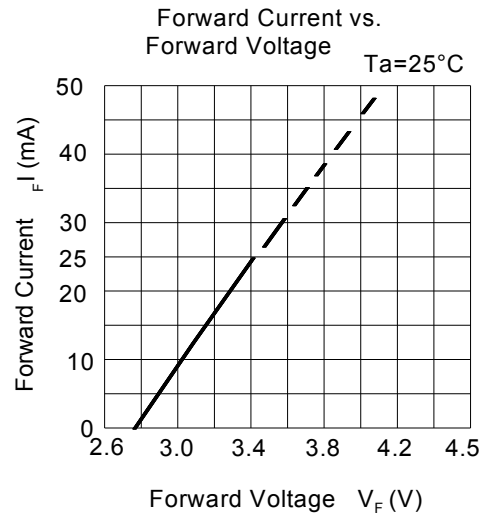
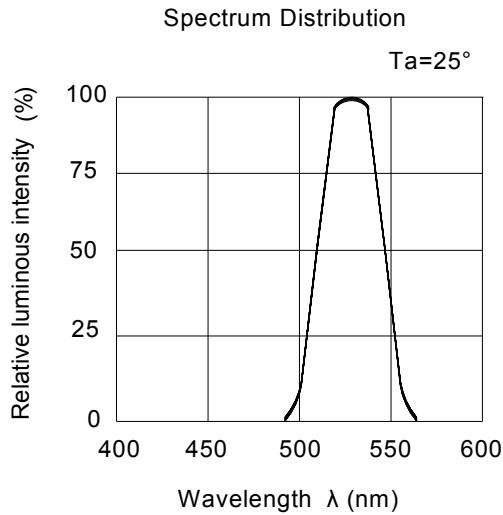

Typical Electro-Optical Characteristics Curves

BH

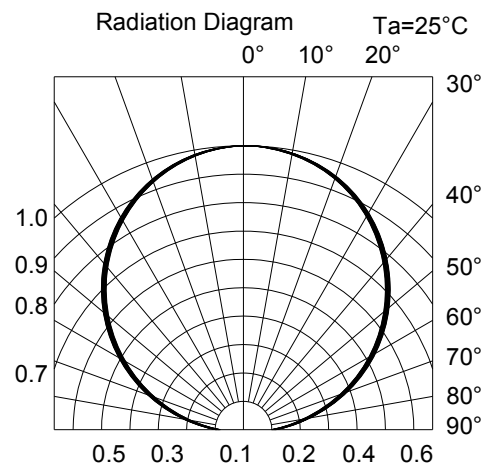
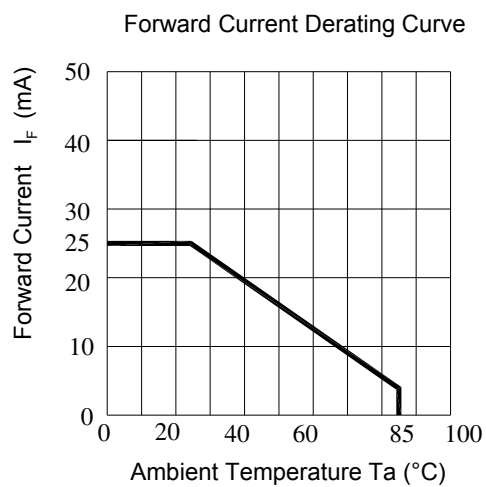
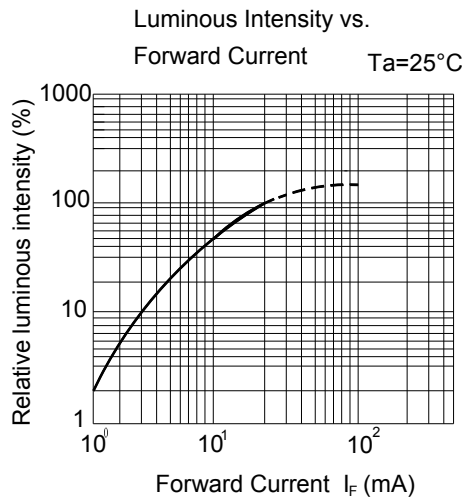
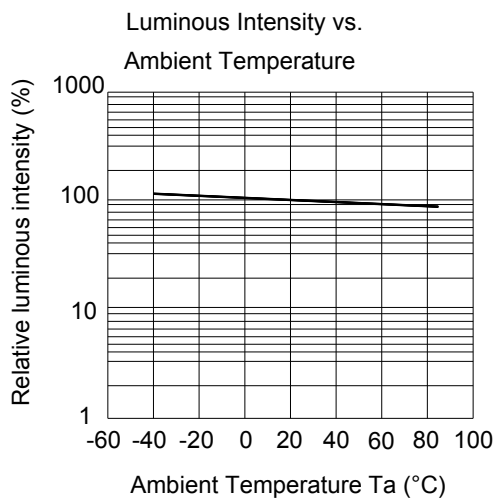
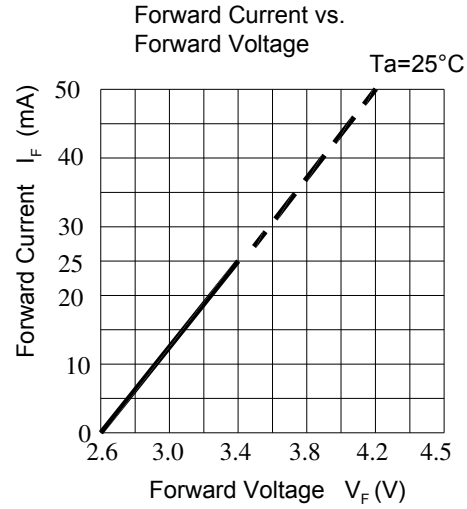
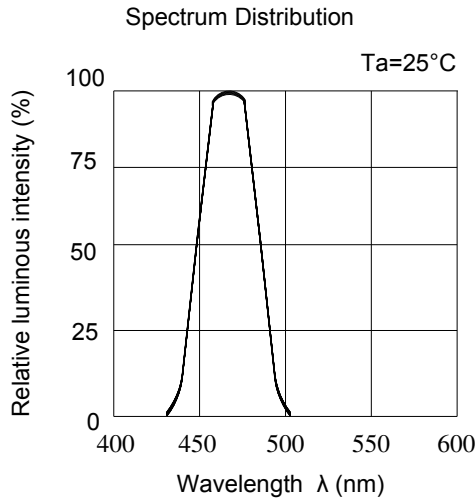

Package Dimension

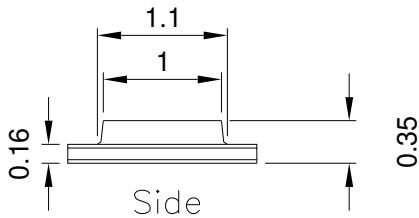
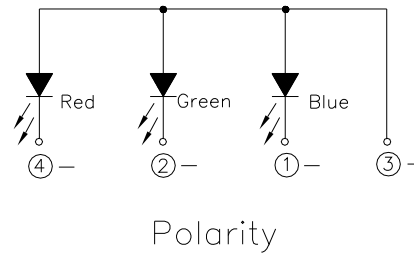
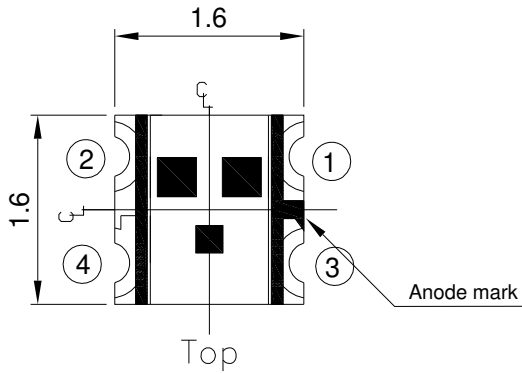

Recommend soldering pad

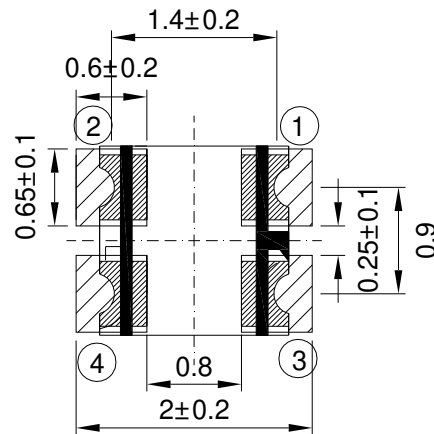
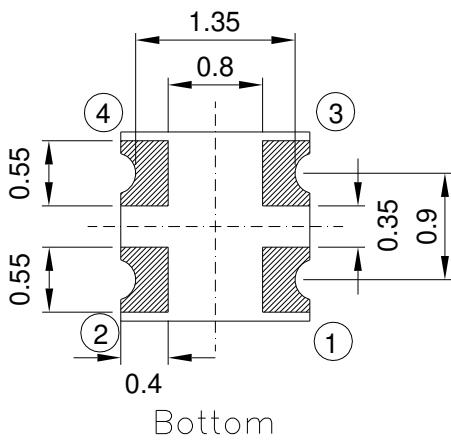

Suggested pad dimension is just for reference only.
Please modify the pad dimension based on individual need.

Note: Tolerances unless mentioned ± 0.1 mm. Unit = mm

Moisture Resistant Packing Materials

Label Explanation

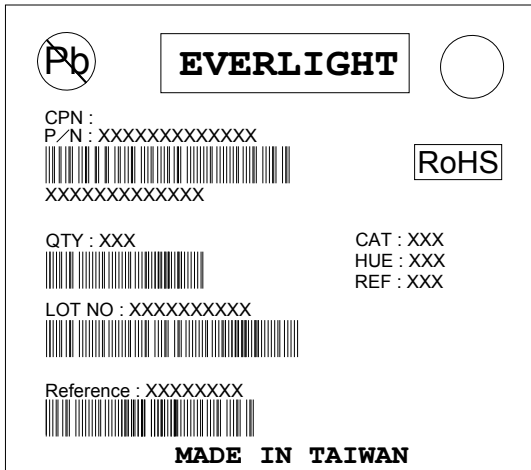

- CPN: Customer's Product Number
- P/N: Product Number
- QTY: Packing Quantity
- CAT: Luminous Intensity Rank
- HUE: Chromaticity Coordinates & Dom. Wavelength Rank
- REF: Forward Voltage Rank
- LOT No: Lot Number

Reel Dimensions

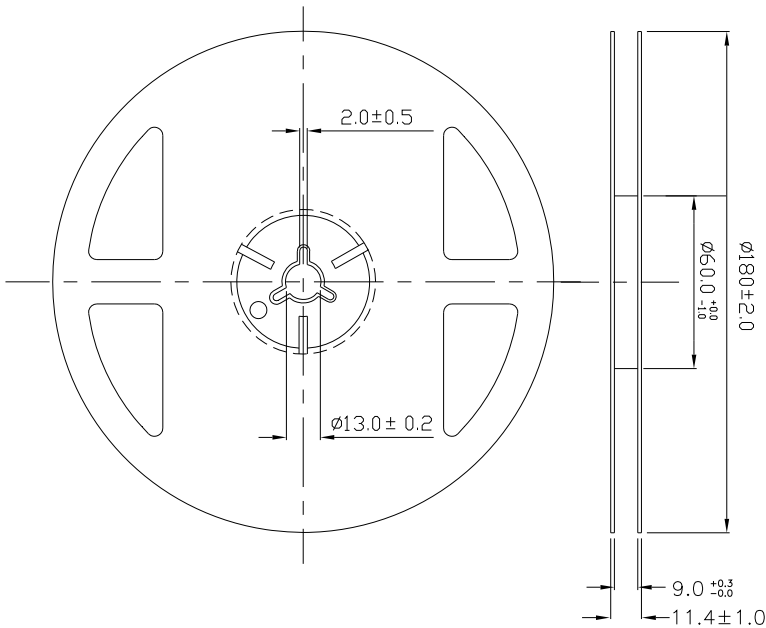

Note: The tolerances unless mentioned is $\pm 0.1\text{mm}$, Unit = mm

Carrier Tape Dimensions: Loaded quantity 2000 PCS per reel

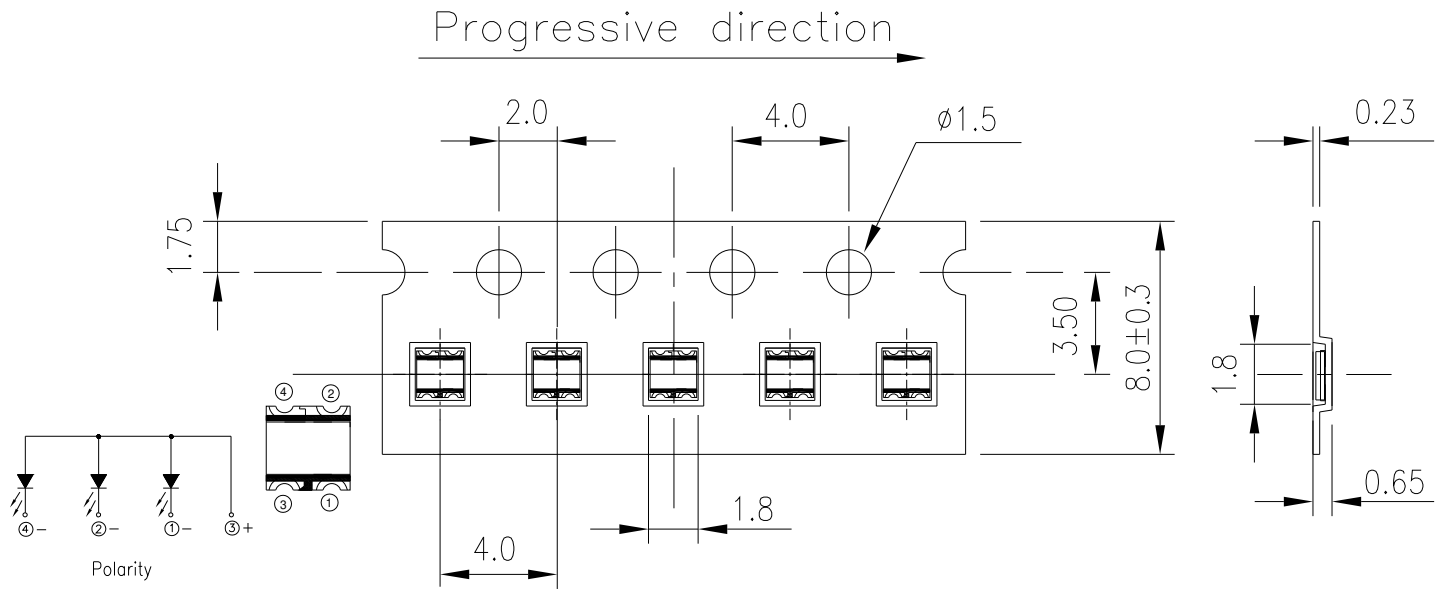

Note: The tolerances unless mentioned is $\pm 0.1\text{mm}$,Unit = mm

Moisture Resistant Packaging

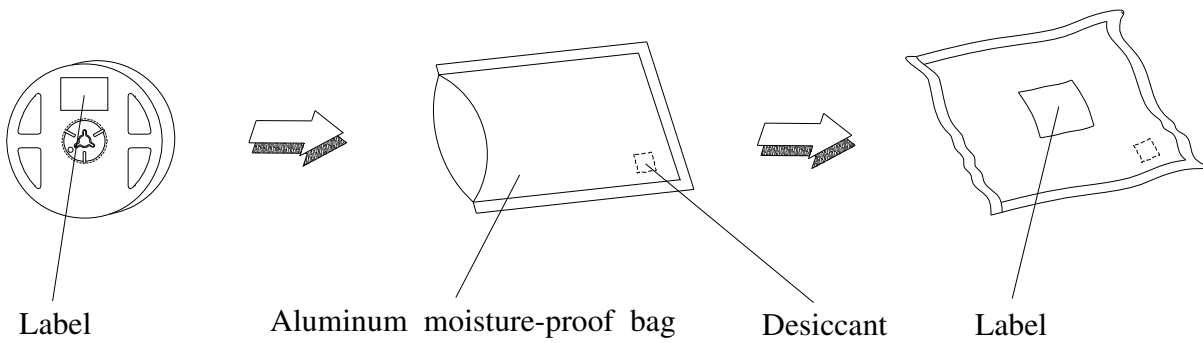

Precautions For Use

1. Over-current-proof

Customer must apply resistors for protection, otherwise slight voltage shift will cause big current change (Burn out will happen).

2. Storage

2.1 Do not open moisture proof bag before the products are ready to use.

2.2 Before opening the package: The LEDs should be kept at 30°C or less and 90%RH or less.

2.3 After opening the package: The LED's floor life is 1 year under 30°C or less and 60% RH or less.

If unused LEDs remain, it should be stored in moisture proof packages.

2.4 If the moisture absorbent material (silica gel) has faded away or the LEDs have exceeded the storage time, baking treatment should be performed using the following conditions.

Baking treatment : 60±5°C for 24 hours.

3. Soldering Condition

3.1 Pb-free solder temperature profile

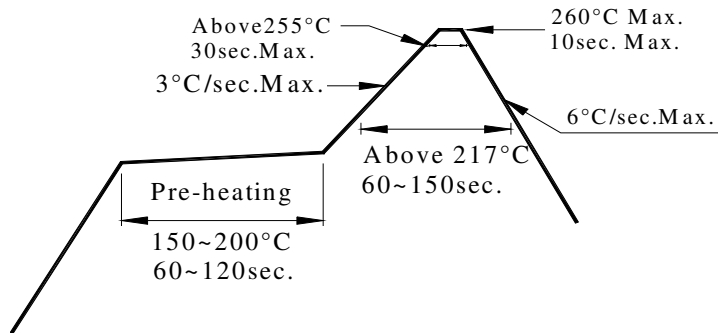

3.2 Reflow soldering should not be done more than two times.

3.3 When soldering, do not put stress on the LEDs during heating.

3.4 After soldering, do not warp the circuit board.

4. Soldering Iron

Each terminal is to go to the tip of soldering iron temperature less than 350°C for 3 seconds within once in less than the soldering iron capacity 25W. Leave two seconds and more intervals, and do soldering of each terminal. Be careful because the damage of the product is often started at the time of the hand solder.

5. Repairing

Repair should not be done after the LEDs have been soldered. When repairing is unavoidable, a double-head soldering iron should be used (as below figure). It should be confirmed beforehand whether the characteristics of the LEDs will or will not be damaged by repairing.

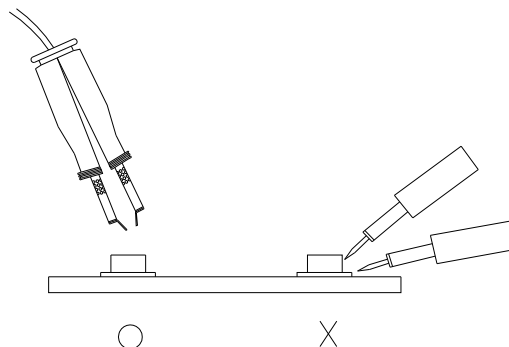

Application Restrictions

High reliability applications such as military/aerospace, automotive safety/security systems, and medical equipment may require different product. If you have any concerns, please contact Everlight Americas before using this product in your application. This specification guarantees the quality and performance of the product as an individual component. Do not use this product beyond the specification described in this document.