

Data Sheet iSYS-6030







Version 1.9—23.12.2020

PRODUCT FAMILY

- 60 GHz Distance Measurement System

APPLICATIONS

- Level Measurement
- Industrial Applications

	Movement
	Velocity
	Direction
	Presence
	Distance
	Angle

FEATURES:

- Radar-based distance measurement system working between 60 GHz and 64 GHz
- Distance measurement with millimeter accuracy
- Small size (50 x 50 x 47 mm) for easy integration into customer housing
- Detection range configurable
- Small 3 dB beamwidth of approx. 6 deg. (azimuth and elevation)
- 4 configurable outputs for control functions
- Successor product for iSYS-6003 with extended functionality

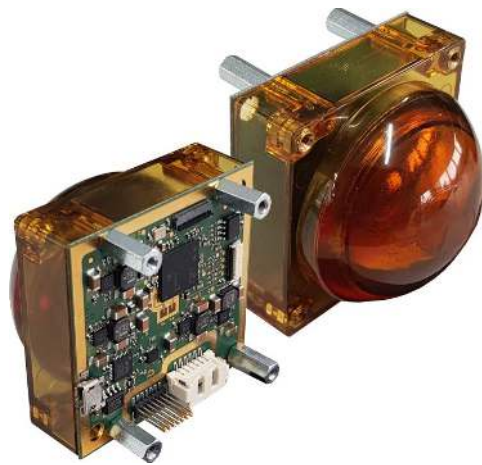

DESCRIPTION

The iSYS-6030 is a complete radar system operating at 60 GHz with intelligent μ C processing to provide customers with an easy to use, ultra accurate measurement system for level measurement and other industrial applications.

Equipped with a specially designed lens, the beam pattern of the system is an incredible 6 degrees, allowing precise measurement of targets in boresight. An innovative DSP algorithm and advanced calibration techniques allow the sensor to achieve millimeter accuracy.

The new system was developed as an almost identical successor product for the iSYS-6003 and offers existing customers the option of simple integration into the customer product.

The sensor provides 4 programmable output pins that offer a wide variety of individual configurations, to make sure that the sensor fits to your individual requirements.

CERTIFICATES

InnoSenT GmbH has established and applies a quality system for: development, production and sales of radar sensors for industrial and automotive sensors. More information on our quality standards:

<https://www.innosent.de/en/company/certifications/>

ADDITIONAL INFORMATION

InnoSenT Standard Product. Changes will not be notified as long as there is no influence on form, fit and within this data sheet specified function of the product.

CONFIDENTIAL AND PROPRIETARY

The information contained in this document shall remain the sole and exclusive property of InnoSenT GmbH and shall not be disclosed by the recipient to third parties without prior consent of InnoSenT in writing.

ELECTRICAL CHARACTERISTICS

PARAMETER	CONDITIONS	SYMBOL	MIN	TYP	MAX	UNITS
Radar						
transmit frequencies		f_t	60		63.8	GHz
output power (EIRP)		P_{out}		10		dBm
Sensor						
detection distance	depending on RCS of target (5 square meter min RCS @ 40 m (static), moving @ 20m)	d_r	≈ 0.10		40	m
detected target velocity	Speed not measured by sensor		0		15	km/h
accuracy	depending on the surface of the illuminated object, starting at 2 m range. Measurements closer typically have an accuracy of ± 2 mm. Range error for moving targets might be higher.			± 0.1		% of Range
resolution	Seperatability of two targets with equal RCS	Δd		12		cm
standard detection field	compare with plot on page 4	horizontal		6		°
		vertical		6		°
rise time of device	sensor ready for acquisition after power up	$t_{powerup}$		70		msec
	Sensor powered up, measurement performed, sensor powered down.	$t_{powercycle}$		110		msec
Power supply						
supply voltage	Note: Max 5V input voltage for evaluation variants with USB connector!	V_{cc}	3.6		16	V
characteristics at 3.6V		I_{cc}		360		mA
		P_{cc}		1.3		W
characteristics at 10 V		I_{cc}		145		mA
		P_{cc}		1.45		W
characteristics at 16V		I_{cc}		100		mA
		P_{cc}		1.6		W
Note: These values are for constant measurement acquisition. Average sensor power is dependent on measurement interval. Average power can be calculated by $(t_{powercycle} / t_{measinterval}) * P_{cc}$.						
E.g. Measurements taken every 1 minute and supplied by 3.6 V $\Rightarrow (0.11 \text{ s} / 60 \text{ s}) * 1.3 \text{ W} = 2.4 \text{ mW}$ average power.						
Digital output current						
OUT 1, OUT 2, OUT 3, OUT 4	Digital output	I_{out}	- 4		4	mA
Environment						
operating temperature		T_{OP}	- 40		+ 85	°C
storage temperature		T_{STG}	- 40		+ 85	°C
Mechanical Outlines						
outline dimensions	compare with drawing	Height		47.1		mm
		Length		50.5		
		Width		50.5		

CONFIDENTIAL AND PROPRIETARY

The information contained in this document shall remain the sole and exclusive property of InnoSenT GmbH and shall not be disclosed by the recipient to third parties without prior consent of InnoSenT in writing.

MEASUREMENT MODES

Depending on your needs, the iSYS-6030 offers four measurement modes to perfectly fit your application.

PARAMETER	CONDITIONS	TYP	UNITS
MULTI TARGET MODE			
number of targets	115200 baud rate ⁽¹⁾	10	targets
update rate		10	Hz
output format		single-target or targetlist	
SINGLE TARGET MODE			
update rate		50	Hz
output format		single-target	
LONG INTEGRATION MODE⁽²⁾			
number of targets	115200 baud rate ⁽¹⁾	10	targets
update rate		4	Hz
output format		single-target or targetlist	
MULTI TARGET MODE (25 HZ)			
number of targets	115200 baud rate ⁽¹⁾	15	targets
update rate		25	Hz
output format		single-target or targetlist	

⁽¹⁾ the default baud rate is 115200

⁽²⁾ long integration mode is optimized for detection of static objects and has a limited maximum range of 20m

CONFIDENTIAL AND PROPRIETARY

The information contained in this document shall remain the sole and exclusive property of InnoSenT GmbH and shall not be disclosed by the recipient to third parties without prior consent of InnoSenT in writing.

DETECTION FIELD OF VIEW

The antenna beamwidth in degrees specifies the off-boresight angle where the transmitted or received energy has dropped down to 50 percent of the maximum value (3dB-beamwidth). It definitely does not mean that beyond this point no transmission or reception is possible. For instance, an object with a very large radar cross-section (truck, metallic door) might very well compensate the loss of the antenna pattern and provide a significant radar return signal. Due to this fact, the detection range of the sensor can vary depending on the RCS (radar cross section) of the detected object. The graphs below show the system pattern @ 62 GHz.

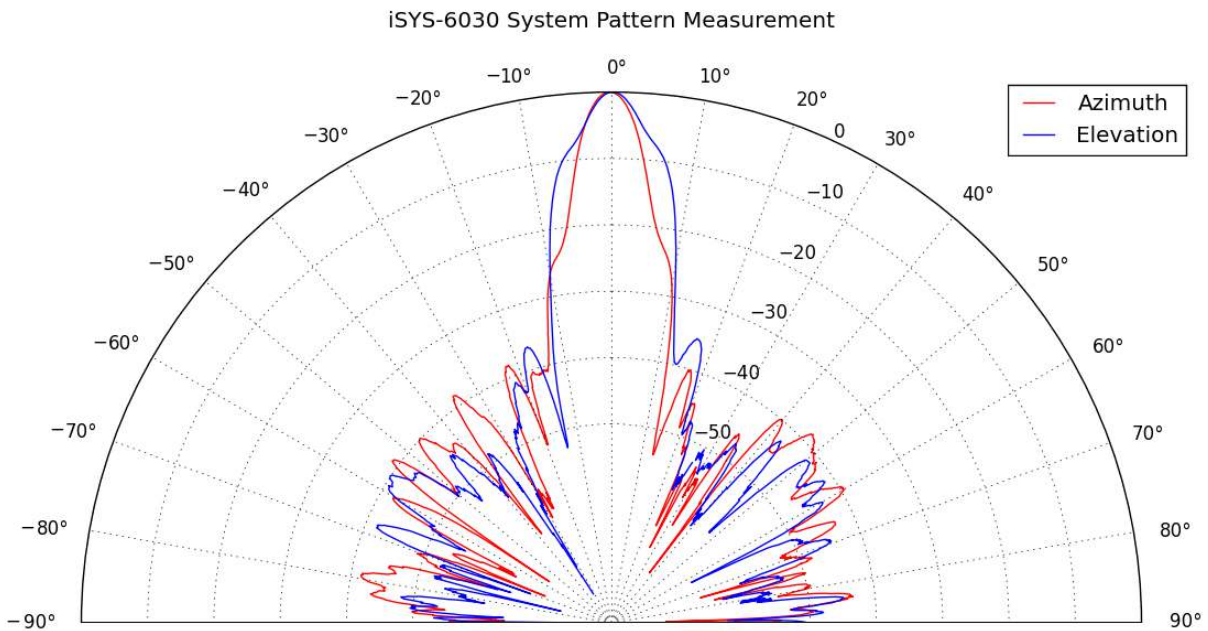

The arbitrary definition of azimuth and elevation.

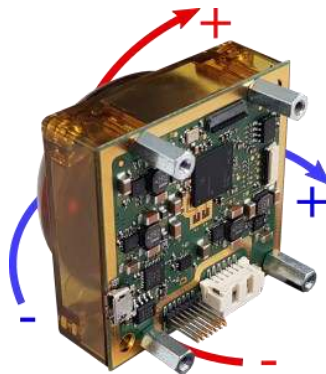

PARAMETER	CONDITIONS	SYMBOL	MIN	TYP	MAX	UNITS
SYSTEM ANTENNA PATTERN						
system pattern (3dB width)	horizontal	azimuth		5.5		°
	vertical	elevation		5.5		°
side-lobe suppression	horizontal	azimuth		35		dB
	vertical	elevation		35		dB
squinting angle	horizontal	azimuth	- 1	0	1	°
	vertical	elevation	- 1	0	1	°

CONFIDENTIAL AND PROPRIETARY

The information contained in this document shall remain the sole and exclusive property of InnoSenT GmbH and shall not be disclosed by the recipient to third parties without prior consent of InnoSenT in writing.

MEASUREMENT DISTANCE DEFINITION

The measurements provided by the sensor are in reference to the tip of the lense, as shown in the graphic to the right.

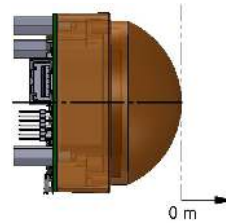

BOARD-TO-BOARD INTERFACE

For customers looking to design their own PCB to interface with the sensor, a 14-pin board-to-board connector is provided. For using the iSYS-6030 with RS485 interface refer the application note included in the iSYS-6030 software package.

Pin Headers, 1.27mm Pitch, Vertical, Double Row

The sensor's connector type: W+P 7075-0XX-16-10-00-PPTR
 Compatible Female Headers is: W+P 6060-0XX-46-00-00-00-PPST

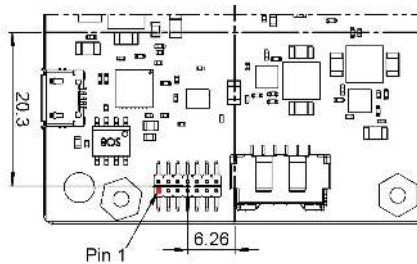
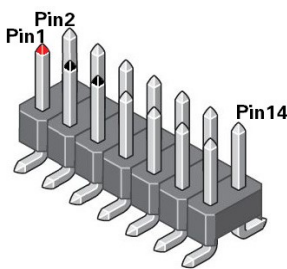

PIN #	DESCRIPTION	IN/OUT	COMMENT
1	V_IN	IN	3.6 V - 16 V supply voltage
2	SCI_RX	IN	UART data in (3.3 V)
3	GND		ground
4	SYS_DISABLE_n	IN	Power-off the sensor completely (Active low) - This is pulled up to V_IN internally and can either be left floating or driven with an open-collector circuit (floating or low).
5	GND		ground
6	SCI_TX	OUT	UART data out (3.3 V)
7	OUTPUT 2	OUT	configurable output (3.3 V) (Default configured function TX_ENABLE, refer to application note for RS485 usage)
8	D.N.C		do not connect
9	OUTPUT 3	OUT	configurable output (3.3 V) (Default configured function STATUS, High means ready)
10	D.N.C		do not connect
11	OUTPUT 0	OUT	configurable output (3.3 V)
12	D.N.C		do not connect
13	OUTPUT 1	OUT	configurable output (3.3 V)
14	D.N.C.		do not connect

CUSTOMER INFORMATION

If the customer has any questions relating to the sensor or how to interface with it, do not hesitate to ask info@innosent.de for possible solutions. We gladly support you with schematic and/or layout recommendations.

CONFIDENTIAL AND PROPRIETARY

The information contained in this document shall remain the sole and exclusive property of InnoSenT GmbH and shall not be disclosed by the recipient to third parties without prior consent of InnoSenT in writing.

BOARD-TO-HARNESS INTERFACE

For customers looking to interface with the sensor directly via a wiring harness, a 6-pin board-to-harness connector is provided with a subset of the pins offered on the 14-pin board-to-board interface. 1.50 mm Pitch, CLIK-Mate PCB Receptacle, Single Row, Surface Mount, Right-Angle, Tin Plating, Positive Lock, 6 Circuits, Natural

The sensor’s connector type: Molex 5025850670
 Compatible female mate is: Molex 502578

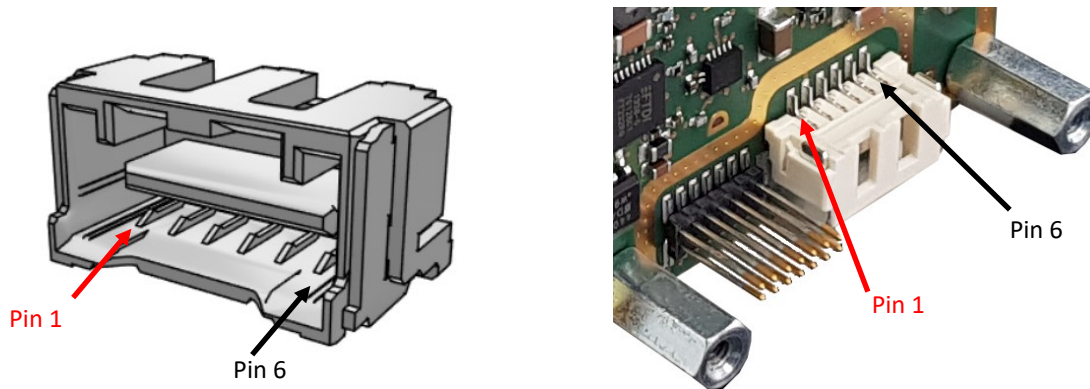

PIN #	DESCRIPTION	IN/OUT	COMMENT
1	V_IN	IN	3.6 V - 16 V supply voltage
2	GND		Ground
3	SCI_RX	IN	UART data in (3.3 V)
4	SCI_TX	OUT	UART data out (3.3 V)
5	OUTPUT 0	OUT	configurable output (3.3 V)
6	OUTPUT 3	OUT	configurable output (3.3 V)

EVALUATION INTERFACE (USB) - NOT AVAILABLE IN SERIES PRODUCTION VARIANT

In order to evaluate the sensor right out of the box, the evaluation variant of the iSYS-6030 comes with a USB connector that can provide both power and communication to the sensor. Just plug in the USB cable to your PC and the sensor, start the software GUI, and you’re ready to measure! The interface is USB 2.0 (UART, 115200 Baud) and uses a USB Micro B cable. This interface is not available in the series-production variant.

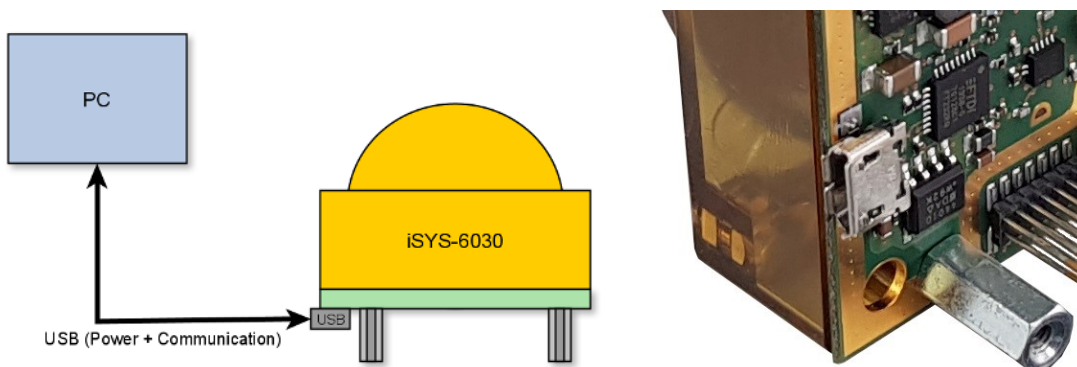

CONFIDENTIAL AND PROPRIETARY

The information contained in this document shall remain the sole and exclusive property of InnoSenT GmbH and shall not be disclosed by the recipient to third parties without prior consent of InnoSenT in writing.

iSYS-6030 Mechanical Dimensions

Alle Rechte vorbehalten
All Rights Reserved

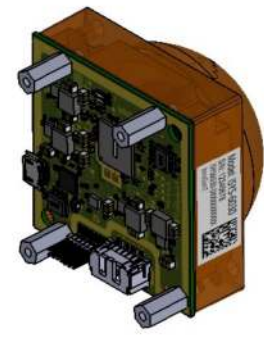
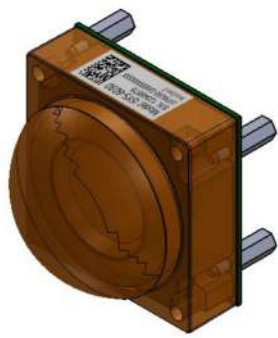
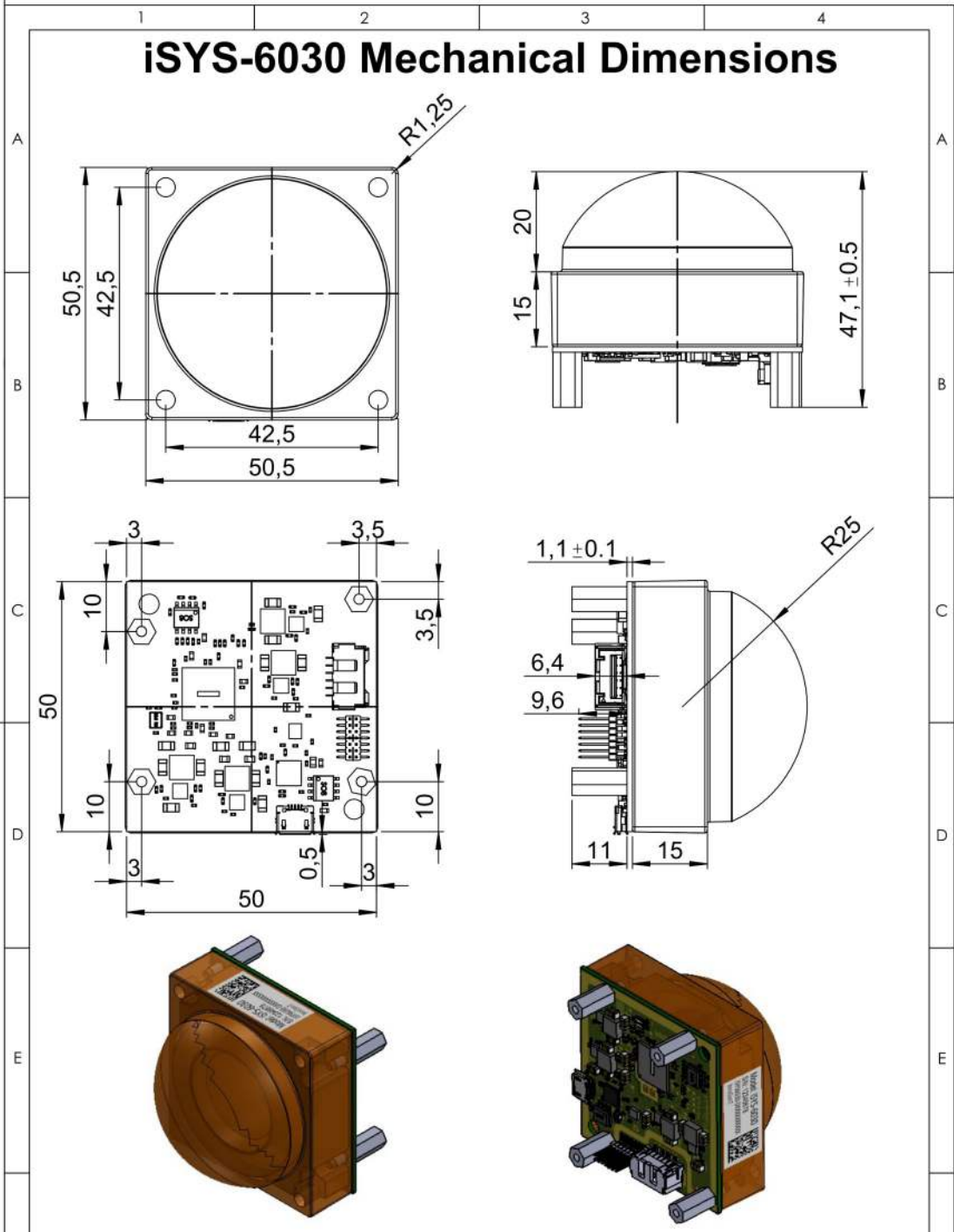

Note: .STEP Model available for ease of design!

All dimensions in mm

<p>InnoSenT InnoSenT GmbH Am Roedertor 30 97499 Donnersdorf, GERMANY</p>	Dokumentart / Documentkind User Manual Mechanical Drawing	Dokumentenstatus / Status Released
	Titel, zusätzlicher Titel / Title, additional title iSYS-6030	Zeichnungs-Nr. / Drawing No. IS20-00009
	Rev. A	Ausgabedatum / Date 03.MAR.2020 Spr. / Lng. EN/DE Blatt / Sheet 1/1

Format / Size A4

B-A4_V1
2011-12-14

CONFIDENTIAL AND PROPRIETARY

The information contained in this document shall remain the sole and exclusive property of InnoSenT GmbH and shall not be disclosed by the recipient to third parties without prior consent of InnoSenT in writing.

MECHANICAL OUTLINES

For mounting the module we recommend using DIN 7991/ISO 10642 M3 x [5mm + mounting plate thickness]

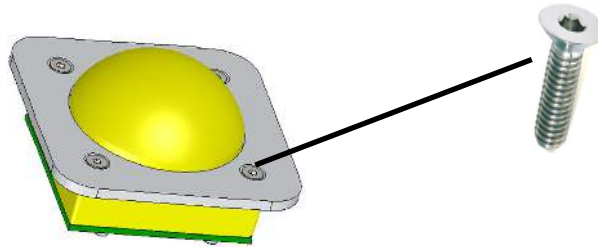

Top view

Threaded socket (4x)
DIN 16903 Form U-M3
DIN EN 12164

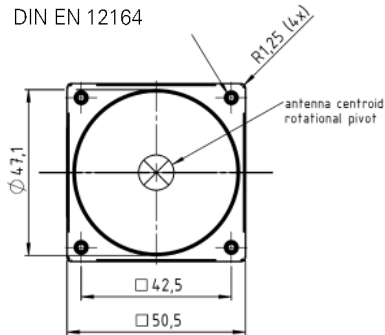

Side view

Label content:
iSYS-6030
S/N: 8-digit
Data Matrix Code

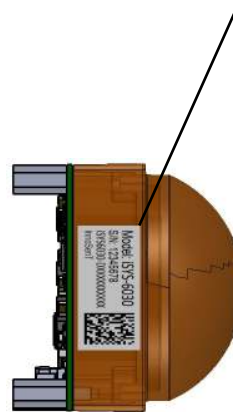

CONFIDENTIAL AND PROPRIETARY

The information contained in this document shall remain the sole and exclusive property of InnoSenT GmbH and shall not be disclosed by the recipient to third parties without prior consent of InnoSenT in writing.

ESD-INFORMATION



This InnoSenT sensor is sensitive to damage from ESD. Normal precautions as usually applied to CMOS devices are sufficient when handling the device. Touching the signal output pins has to be avoided at any time before soldering or plugging the device into a motherboard.

APPROVAL

This data sheet contains the technical specifications of the described product. Changes of the specification must be in written form. All previous versions of this data sheet are no longer valid.

VERSION	DATE	COMMENT
1.0	03.04.2020	Initial release
1.1	24.04.2020	Updated limited voltage range for USB variant
1.2	04.05.2020	Listed UART pin error on 14 pin connector (page 5)
1.3	04.06.2020	- Removed UART pin error warning as it has been fixed on the new version - Changed Accuracy specification to match measured performance.
1.4	28.07.2020	updated measurement modes
1.5	03.09.2020	Added target speed
1.6	07.09.2020	Added notes for RS485 usage
1.7	16.09.2020	Added note on SYS_DISABLE_n pin on page 5.
1.8	23.11.2020	Added long integration measurement mode Removed user configurable transmit power which is no longer available to the user
1.9	23.12.2020	Added new multi target mode with 25 Hz update rate and up to 15 targets.

InnoSenT GmbH

Am Roedertor 30
97499 Donnersdorf
GERMANY

Tel.: +49 (0) 9528—9518—0
E-Mail: info@innosent.de
URL: www.innosent.de

CONFIDENTIAL AND PROPRIETARY

The information contained in this document shall remain the sole and exclusive property of InnoSenT GmbH and shall not be disclosed by the recipient to third parties without prior consent of InnoSenT in writing.