

DATASHEET

# Lama

SRFI065 • flexiANT<sup>®</sup>



## Features

- Antenna for ISM and LoRa<sup>®</sup> bands (863 – 870MHz and 902 - 928MHz)
- 1.13mm diameter RF cable with I-PEX MHF connector
- Self-adhesive mounted
- Quick integration minimizes design cycle
- High efficiency within a small area
- 100mm cable – (other lengths available)
- Maintains high performance within device: DFI (Designed For Integration)

# Contents

<b>1.</b>	<b>Description</b>	<b>2</b>
<b>2.</b>	<b>Applications</b>	<b>2</b>
<b>3.</b>	<b>General data</b>	<b>2</b>
<b>4.</b>	<b>Part number</b>	<b>3</b>
<b>5.</b>	<b>RF characteristics</b>	<b>3</b>
<b>6.</b>	<b>RF performance</b>	<b>4</b>
<b>6.1.</b>	Return loss	4
<b>6.2.</b>	VSWR	4
<b>6.3.</b>	Efficiency	5
<b>6.4.</b>	Antenna pattern	6
<b>7.</b>	<b>Antenna dimensions</b>	<b>8</b>
<b>7.1.</b>	Dimensions FPC section	8
<b>7.2.</b>	Dimensions assembled	8
<b>7.3.</b>	IPEX connector MHF1 (20278-112R-13)	9
<b>7.4.</b>	Assembly	9
<b>8.</b>	<b>Electrical interface</b>	<b>10</b>
<b>8.1.</b>	Host interface	10
<b>8.2.</b>	Transmission line	10
<b>9.</b>	<b>Mechanical fixing</b>	<b>10</b>
<b>10.</b>	<b>Antenna integration guide</b>	<b>11</b>
<b>10.1.</b>	Antenna placement	11
<b>10.2.</b>	Orientation of FPC	12
<b>11.</b>	<b>Hazardous material regulation conformance</b>	<b>13</b>
<b>12.</b>	<b>Packaging</b>	<b>13</b>
<b>12.1.</b>	Optimal storage conditions	14
<b>12.2.</b>	Label information	14

## 1. Description

---

Lama is a flexible PCB antenna with a cable that connects to the host PCB giving easy integration. The antenna covers both ISM bands (863 – 870MHz and 902 - 928MHz). Dimensions of Lama are 35\*10\*0.15mm.

## 2. Applications

---

- LoRa® wireless nodes
- LoRa® Gateway/Routers
- Smart meters
- Home automation
- Monitoring equipment
- Smart Grids
- Remote sensors

## 3. General data

---

FREQUENCY	863-870MHz 902-928MHz
POLARIZATION	Linear
OPERATING TEMPERATURE	-40°C to +85°C
ENVIRONMENTAL CONDITION TEST	ISO16750-4 5.1.1./5.1.2
IMPEDANCE	50 Ω
WEIGHT	<0.5g
ANTENNA TYPE	FPC Self-adhesive 3M 468MP
DIMENSIONS (ANTENNA)	35.0 x 10.0 x 0.15 (mm)
CONNECTION	I-PEX MHF1 (20278-112R-13)

## 4. Part number

---

LAMA  
SRFI065

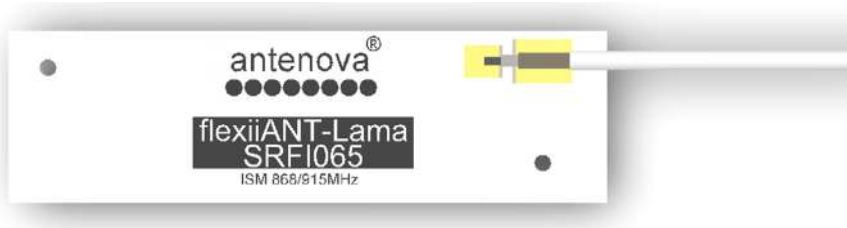

## 5. RF characteristics

---

	863-870MHZ	902-928MHZ
PEAK GAIN	0.82dBi	1.33dBi
AVERAGE GAIN (LINEAR)	-2.84dBi	-2.78dBi
AVERAGE EFFICIENCY	52%	52%
MAXIMUM RETURN LOSS	-15dB	-15dB
MAXIMUM VSWR	1.5:1	1.5:1

*All data measured on SRFI065-100 in a loaded condition adhered to a plastic carrier in free space.*

## 6. RF performance

### 6.1. Return loss

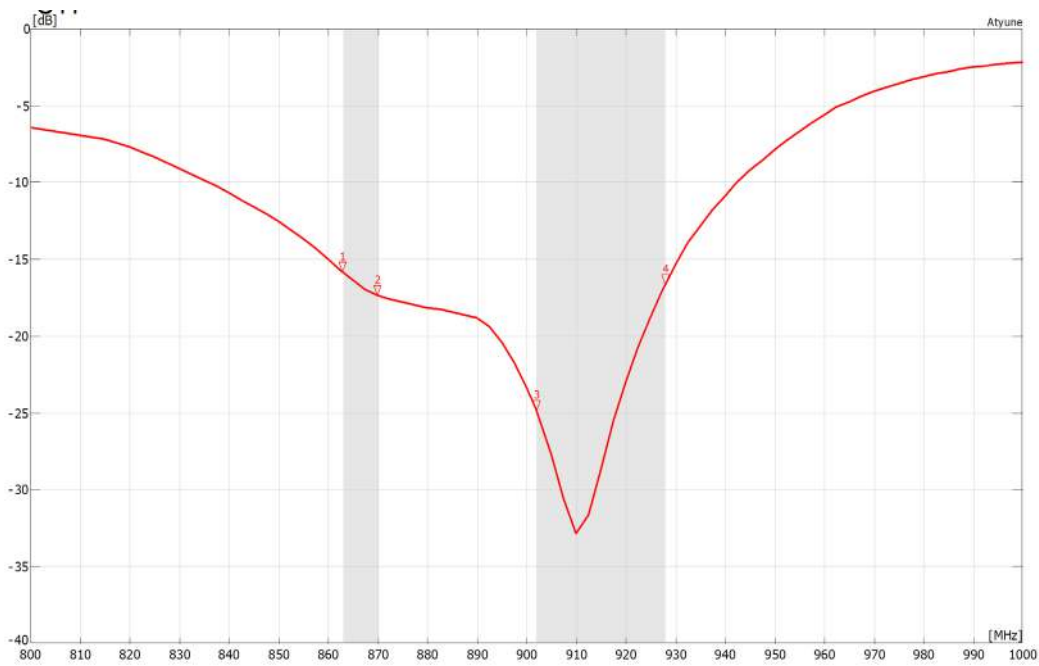

### 6.2. VSWR

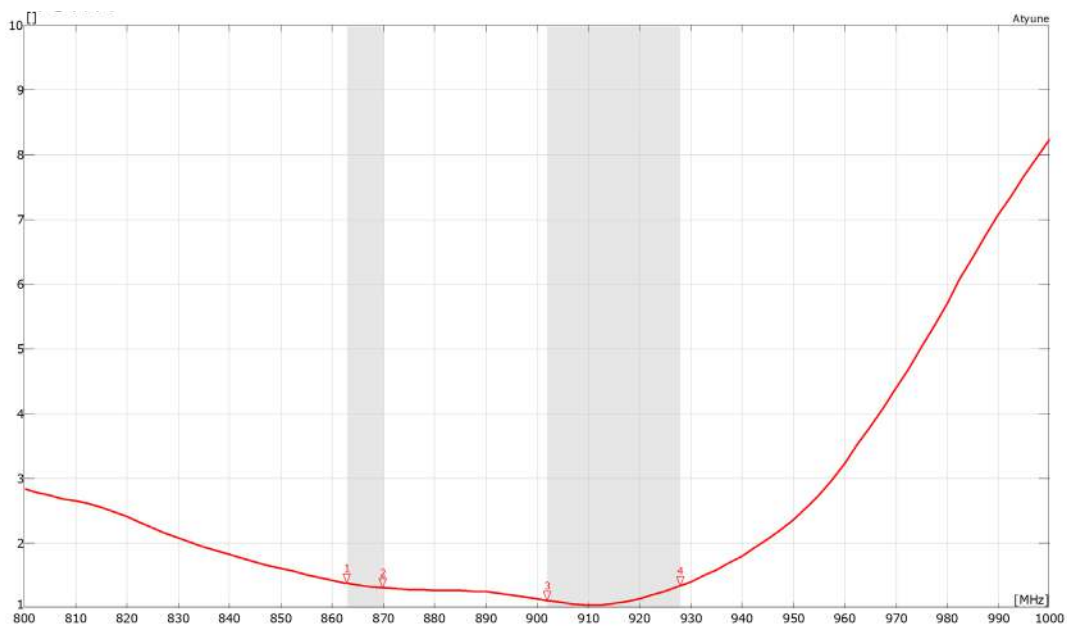

All data measured on SRFI065-100 in a loaded condition adhered to a plastic carrier in free space.

6.3. Efficiency

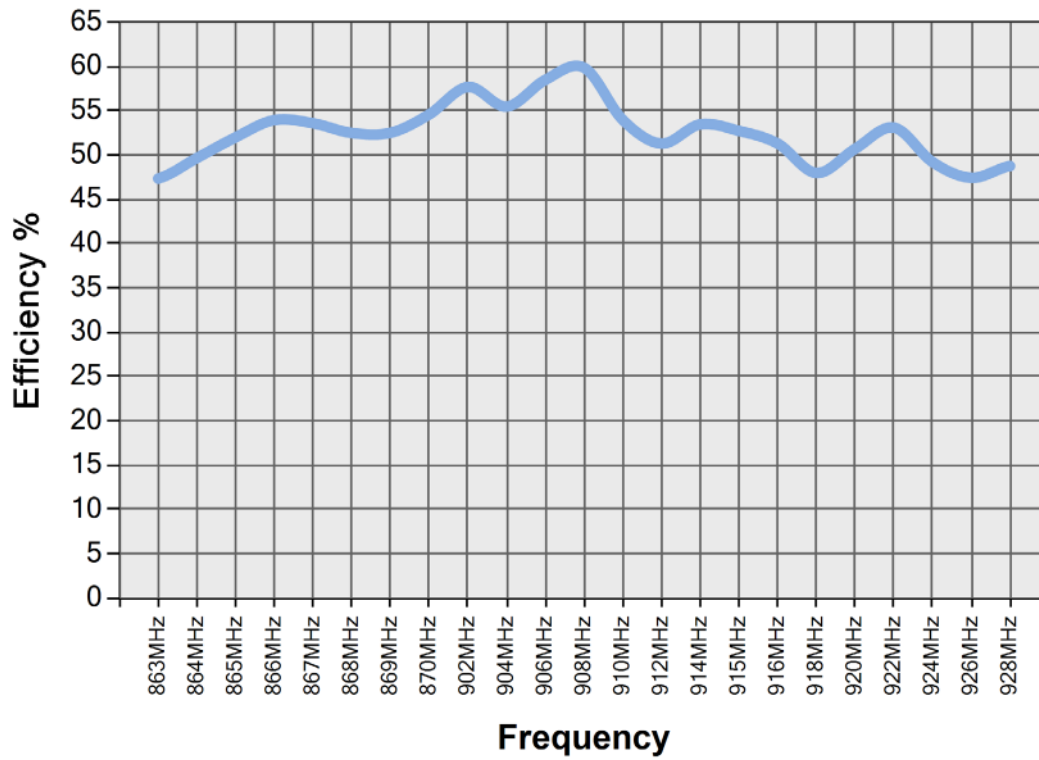

All data measured on SRFI065-100 in a loaded condition adhered to a plastic carrier in free space.

### 6.4. Antenna pattern

#### 6.4.1. 863 MHz – 870 MHz

3D pattern at 868MHz

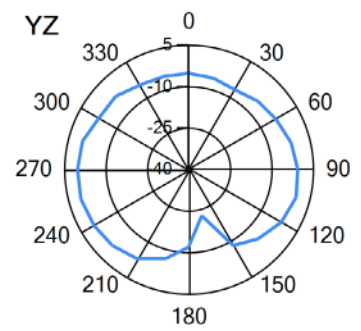
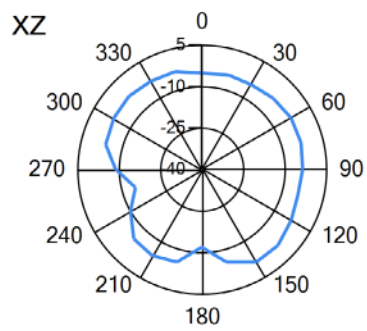
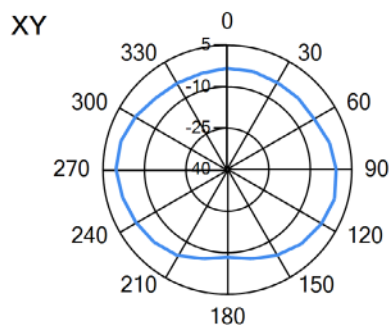
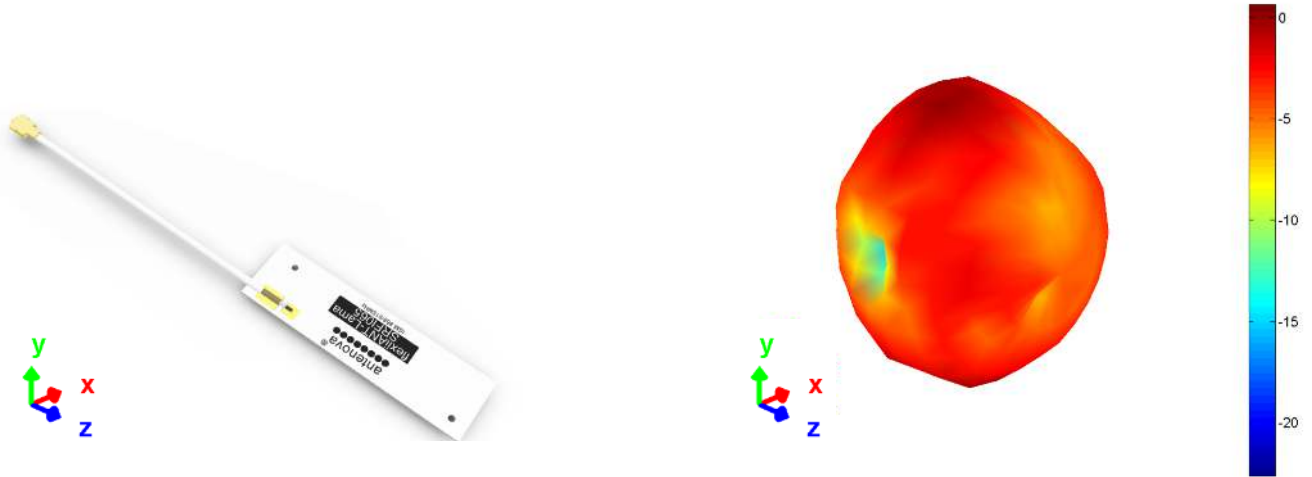

— 868MHz

6.4.1. 902 MHz – 928 MHz

3D pattern at 915MHz

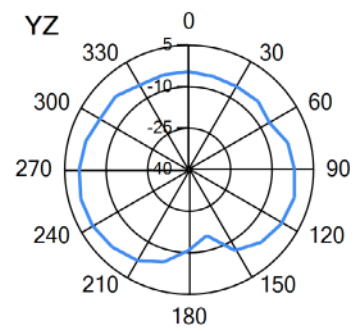
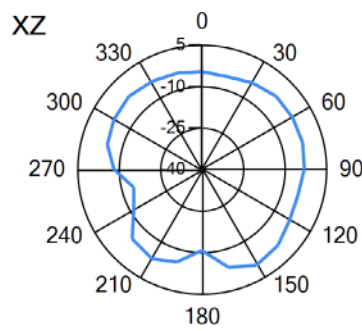
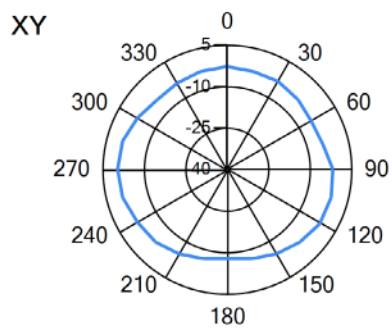
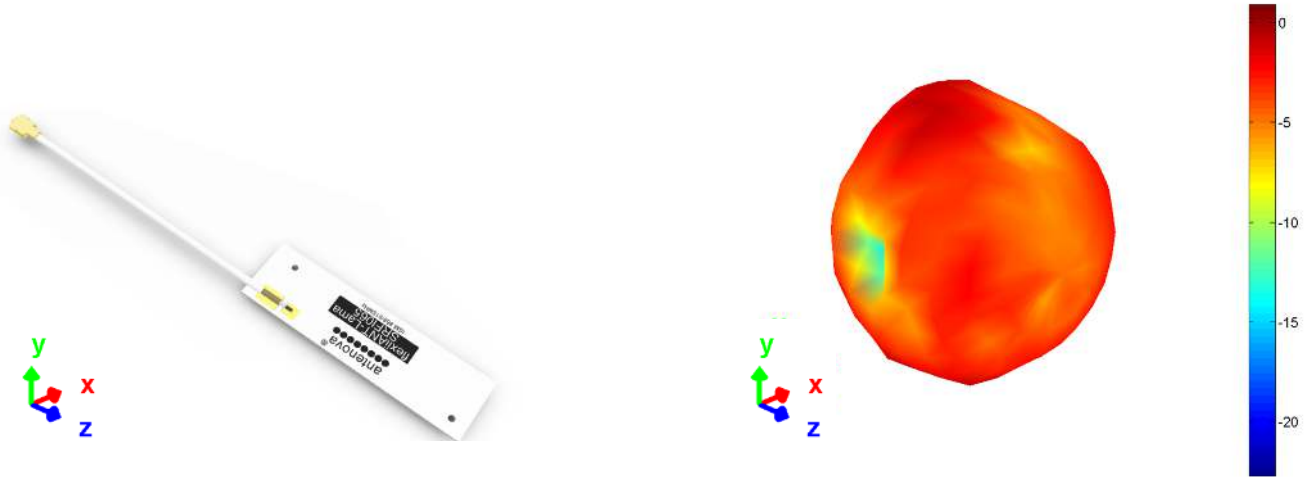

— 915MHz



## 7. Antenna dimensions

### 7.1. Dimensions FPC section

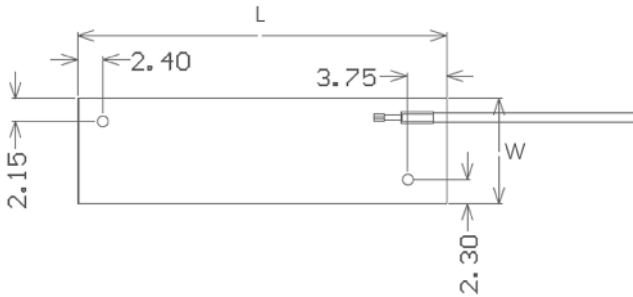

L	W	T
Length	Width	Thickness
35.0 ±0.1	10.0 ±0.1	0.15 (nominal)

All dimensions in (mm)

### 7.2. Dimensions assembled

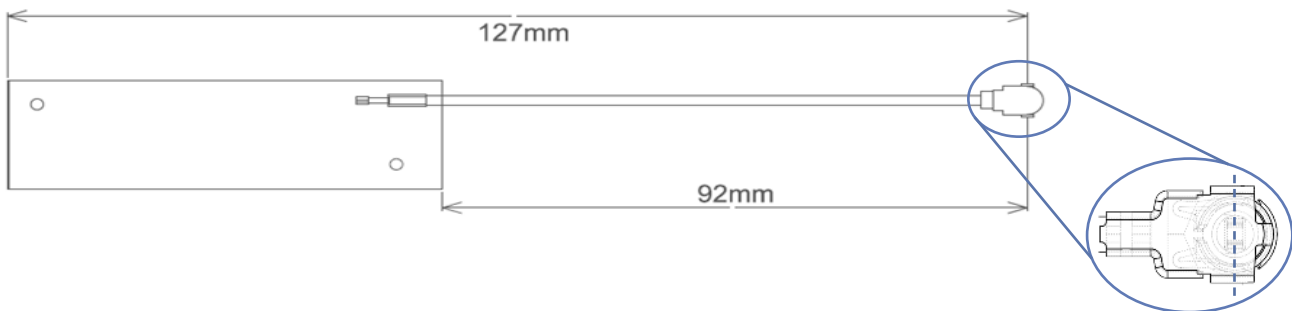

SRFI065-100
Length
127.0 ±2.0

All dimensions in (mm)

Standard cable length for this antenna is 100mm

7.3. I-PEX connector MHF1 (20278-112R-13)

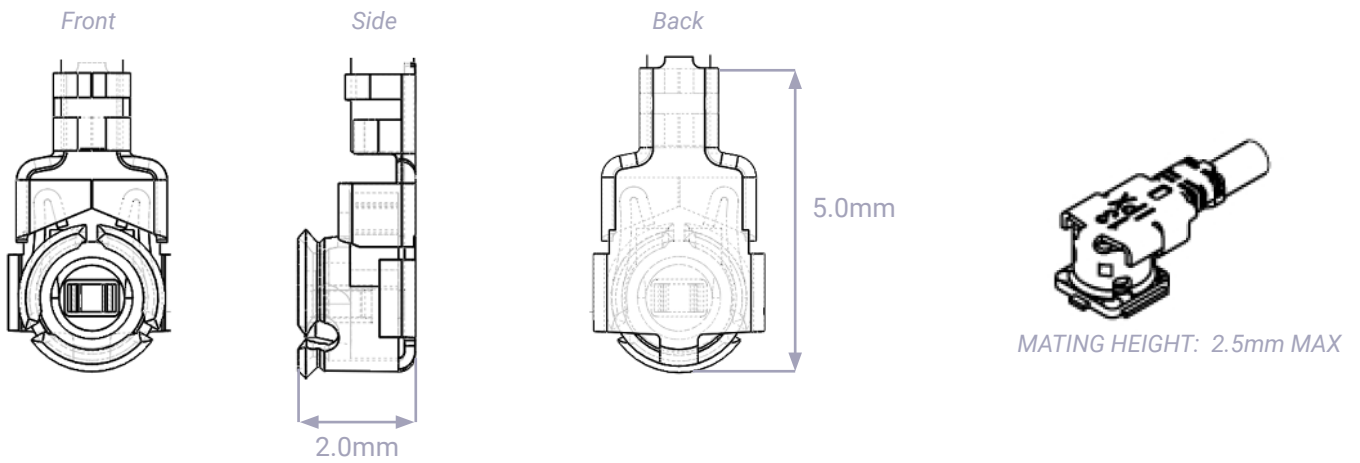

	I-PEX
MATERIAL	Copper Alloy
PLATING	Ag

All dimensions in (mm)

7.4. Assembly



## 8. Electrical interface

---

### 8.1. Host interface

---

The host PCB requires the mating connector which is the I-PEX MHF (UFL) receptacle. The location should be close to the chip/modules pin for the RF. Any feed from this receptacle should be maintained at 50Ω impedance

### 8.2. Transmission line

---

- Must have a characteristic impedance of 50Ω.
- Length should be kept to a minimum.
- Is recommended to be a co-planar waveguide: log on to [Antenova.com](https://www.antenova.com) and try our [Transmission line calculator](#) to easily calculate the dimensions most suited to your requirements.
- Should have DC blocking capacitor (e.g. 220pF) placed in line to protect the RF front end.

## 9. Mechanical fixing

---

The antenna uses 3M 468MP adhesive on the reverse side of the FPC. The antenna has an easy access split line to peel off to reveal the adhesive side. It is designed for a one time fix to a clean smooth surface. The antenna is keyed with two 1mm locating holes for easy positioning.

*FPC back side*

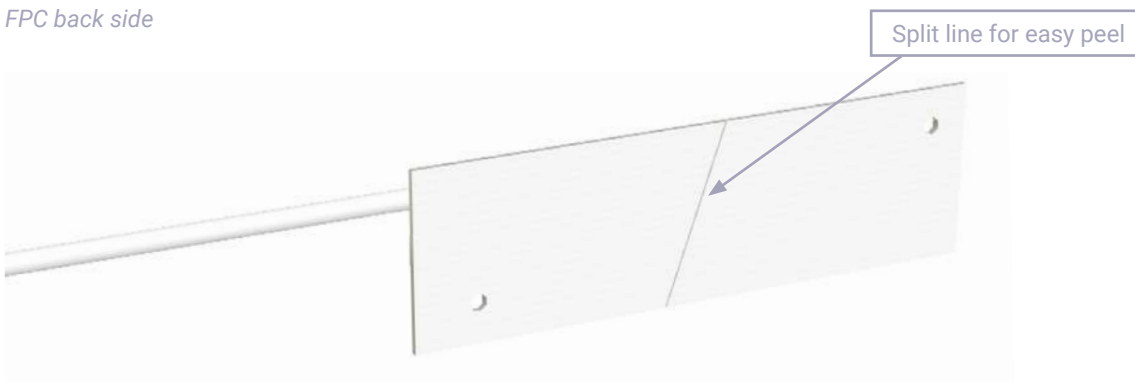

## 10. Antenna integration guide

---

We recommend the following during the design phase to maximise antenna performance and minimize noise:

- Minimum 4 layer PCB
- Route signals and power internally where possible
- Flood all layers with ground
- Knit ground on all layers together with plenty of vias

Follow placement guidance carefully, in addition Antenova provide technical support to help you through all stages of your design. Register for an account on <https://ask.antenova.com/> to access technical support.

### 10.1. Antenna placement

---

For FPC antennas the host PCB size is not critical to performance, however consideration must be given to placement. Using six spatial directions, as shown below, the antenna should ideally maintain a minimum of three directions free from obstruction in order to radiate effectively. Where there are obstructions (e.g. PCB, metal parts, battery etc.) a minimum clearance should still be maintained. These minimum clearances are described later in this section.

*Six spatial directions relative to FPC*

*Example with 5 spatial directions clear*

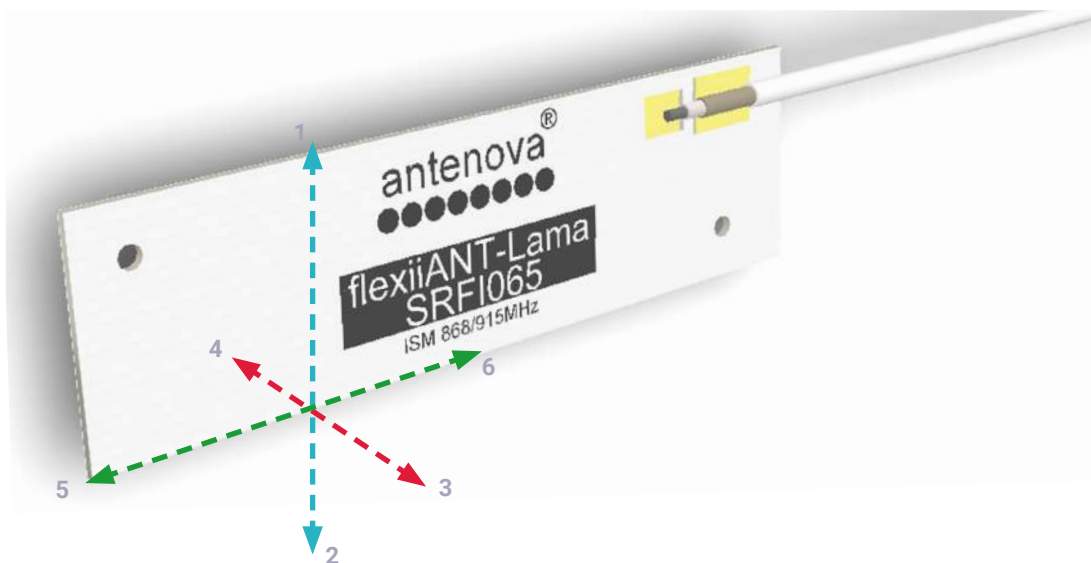

## 10.2. Orientation of FPC

---

The orientation of the FPC with respect to the host PCB should be defined depending on the unit. The proximity of the GND will have an influence on the antenna so the PCB location relative to the antenna should be considered.

The FPC will normally be placed in one of the three following options for orientation. In each option a distance (d) is the critical dimension to consider. The diagram below shows the minimum value of (d) for each. Other obstructions may increase this dimension.

### *Vertical mounted*

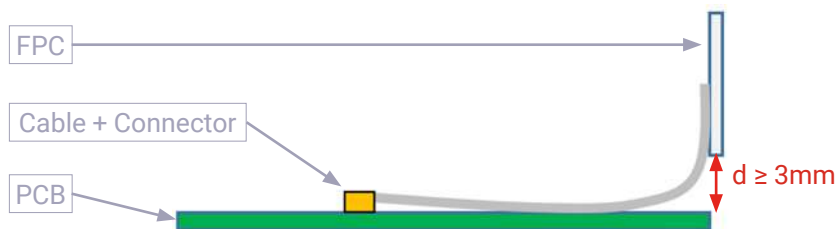

### *Co-planar to PCB*

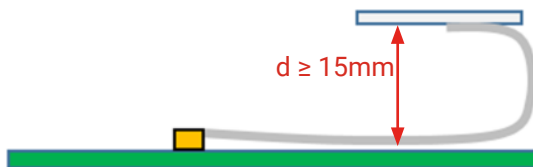

### *Planar to PCB (Same plane)*



## 11. Hazardous material regulation conformance

---

The antenna has been tested to conform to RoHS and REACH requirements. A certificate of conformance is available from Antenova's website.

## 12. Packaging

---

The antennas are stored within a plastic bag of 100 pcs.

*100 units per bag (Labelled)*



### 12.1. Optimal storage conditions

TEMPERATURE	-10°C to 40°C
HUMIDITY	Less than 75% RH
SHELF LIFE	18 Months
STORAGE PLACE	Away from corrosive gas and direct sunlight
PACKAGING	Antennas should be stored in unopened sealed manufacturer's plastic packaging.

Note: The shelf life of the antenna is 18 months, provided the bag of 100 pieces remains factory- sealed.

### 12.2. Label information



### Quality statements

Antenova’s products conform to REACH and RoHS legislation. For our statements regarding these and other quality standards, please see antenova.com.



Antenova reserves all rights to the contents of this document. Antenova gives no warranties based solely on the accuracy or completeness of the contents of this document and reserves the right to make changes to the specifications of the products described herein at any time and without notice.

### Datasheet version

1.01 released Apr 22th 2022

# Antenna design, integration and test resources

Product designers – the details contained in this datasheet will help you to complete your embedded antenna design. Please follow our technical advice carefully to obtain optimum antenna performance.

We aim to support our customers to create high performance wireless products. You will find a wealth of design resources, calculators and case studies to aid your design on our website.

Antenova's design laboratories are equipped with the latest antenna design tools and test chambers. We provide antenna design, test and technical integration services to help you complete your design and obtain the required certifications.

If you cannot find the antenna you require in our product range, please contact us to discuss creating a custom antenna to meet your exact requirements.

Share knowledge with RF experts around the world.

**ask.antenova** is a global forum for designers and engineers working with wireless technology.

[VISIT ASK.ANTENOVA](https://www.ask.antenova.com)

Visit [antenova.com](https://www.antenova.com)

Order antenna samples and evaluation boards, and read our antenna resources

[VISIT ANTENOVA.COM](https://www.antenova.com)

Request a volume quotation for antennas:

[sales@antenova.com](mailto:sales@antenova.com)

Global headquarters

**Antenova Ltd, 2nd Floor Titan Court, 3 Bishop Square, Hatfield, AL10 9NA**

**+44 (0) 1707 927589**