

UNCONTROLLED DOCUMENT

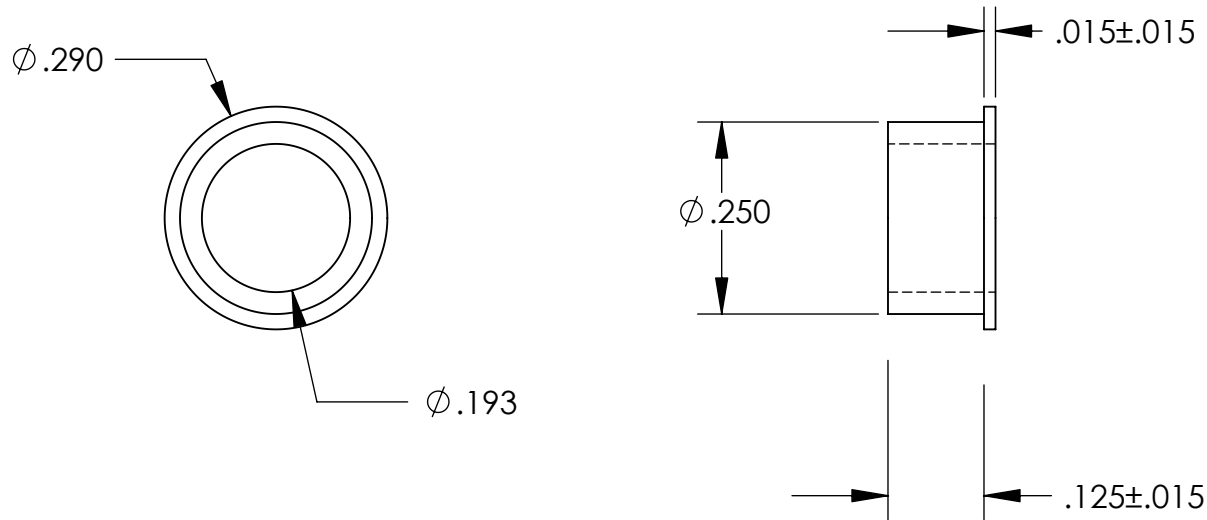

TOLERANCES UNLESS NOTED

- $\pm .005$ ON DIMENSIONS THRU $.625$
- $\pm .008$ ON DIMENSIONS $.626$ THRU 1.000
- $\pm .010$ ON DIMENSIONS 1.001 THRU 1.500
- $\pm .015$ ON DIMENSIONS LARGER THAN 1.500
- $\pm .015$ ON FRACTIONAL DIMENSIONS

WE RESERVE THE RIGHT
TO DISCONTINUE ITEMS,
CHANGE SPECIFICATIONS
OR DESIGN AT ANY TIME
WITHOUT NOTICE AND
WITHOUT INCURRING
ANY OBLIGATIONS

PROPERTY OF		
MICRO PLASTICS INC.		
CATALOG DRAWING SHOULDER WASHER MICRO P/N 12SWS0219 DWG. # 12SWS0219 FILE SERVER\ENG\WEB		
MATERIAL:		6/6 NYLON
DATE	SCALE	TA
	4:1	