

IRDC2085S-DF DEMO BOARD EVALUATION PROCEDURE

International Rectifier • 233 Kansas Street, El Segundo, CA 90245 USA

Overview

This document describes how to connect and evaluate the supplied IRDC2085S-DF demo board. The demo board incorporates a new DC Bus Converter chipset in a fixed-frequency, open-loop isolated half-bridge DC-DC converter with 6:1 input to output voltage conversion ratio. The chipset consists of a primary side IC (IR2085S), two 80V primary side FETs (IRF7493), two 30V secondary side FETs (IRF6618), a primary side biasing FET (IRF7380) and a secondary side gate clamp FET (IRF9956). The front side of the demo board is shown in Fig. 1.

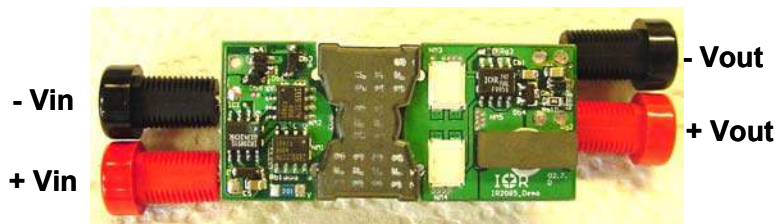

***IRDC2085S-DF 150W DC Bus Demo Board**

Fig. 1 Front side of the DC Bus Converter demo board with IR2085S ChipSet with marked input and output pins. This version of the Demo Board employs DirectFET Power MOSFETs for secondary synchronous rectification *

IRDC2085S-DF Quick Evaluation Procedure

To evaluate the operation and performance of the IRDC2085S-DF demo board, connect a power supply to its input terminals, and a power load to its output terminals. Input and output terminals are marked in Fig. 1. To duplicate the performance data reported on page two, approximately 400 LFM of airflow is needed across the module.

The circuit will start to operate as soon as the primary Vcc reaches about 9V – typically at 12Vin. At this low input voltage, the output voltage will be only about 2V, and the secondary Vcc will be insufficient to fully enhance the secondary side synchronous rectifier MOSFETs. To avoid excessive body diode conduction losses, output current during slow input voltage ramp-up should be set at less than 2A.

IRDC2085S-DF Demo Board Description and circuit capability

The circuit is designed to deliver continuous 20A output current in 36V – 60V input voltage range, with 400 LFM of airflow. Output voltage for this input voltage range will vary from 6V to 10V, and the total available output power from the module will range from around 120W at 36V to up to 200W at 60V input.

The circuit design is optimized in order to demonstrate true performance of the IR2085S control IC, IRF7493 primary FETs and IRF6618 secondary DirectFETs. Therefore, no test pins are available on the board. To probe the circuit waveforms use an oscilloscope probe with minimal length for the ground pin and connect directly to the pins of the IC / MOSFET device.

To measure circuit efficiency, voltage and current at the input and output of the demo board need to be accurately measured. Use of calibrated shunts for input and output current measurements is strongly recommended, as is use of a thermal camera for thermal performance evaluation

A complete schematic of the demo board is shown in Fig. 2. Typical efficiency and a thermal image for 150W output power at 48V_{in} are shown in Fig. 3. Inputs and outputs of two or more modules can be connected in parallel to provide required output power higher than 150W. Due to natural output voltage droop associated with open-loop operation, no additional circuitry is required for relatively accurate current sharing (in the range of +/- 10%).

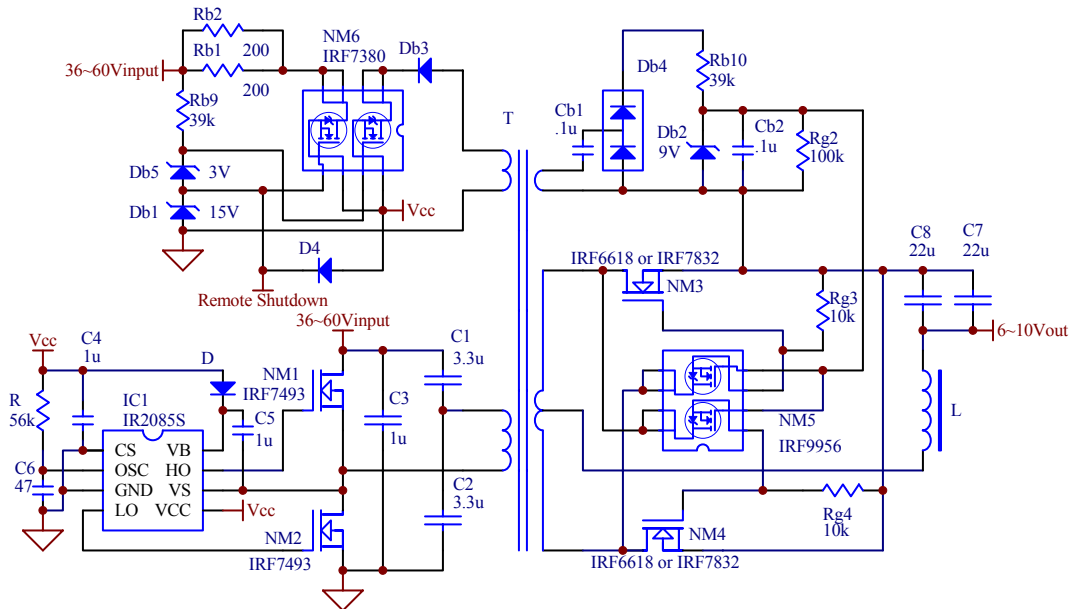

Fig. 2 Complete schematic of IRDC2085S-DF Demo Board

IRF7493 Primary Side and IRF6618 Secondary

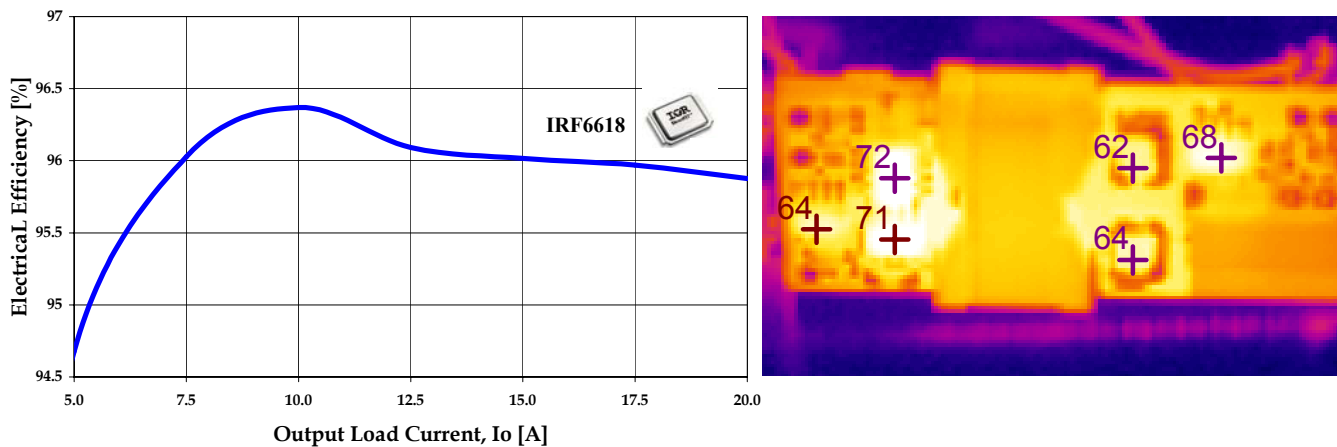
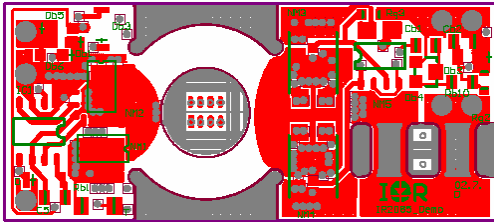

Fig. 3 Efficiency and Thermal image at 48V_{in}, 150W out max, @ 400LFM

*IR2085S demo board has (2) versions:

- IRDC2085S-DF (uses IRF6618 DirectFET MOSFETs for secondary synchronous rectifiers NM3 & NM4)
- IRDC2085S-S (uses IRF7832 SO8 MOSFET for secondary synchronous rectifiers NM3 & NM4)

IRDC2085S-DF Demo Board PCB Layout (Total of 8 layers)



Top Layer

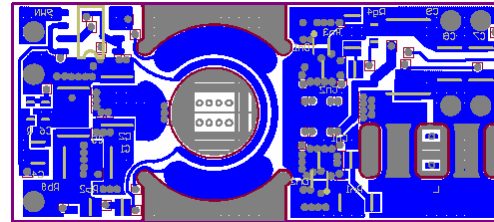

Bottom Layer

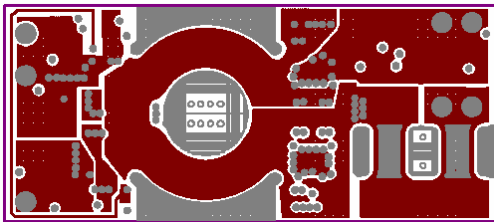

Layer #1

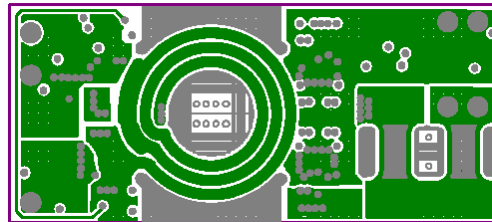

Layer #2

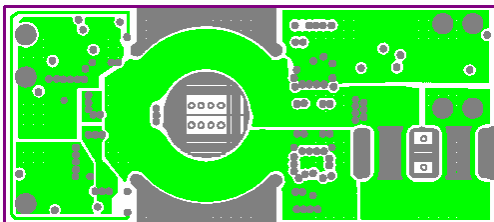

Layer #3

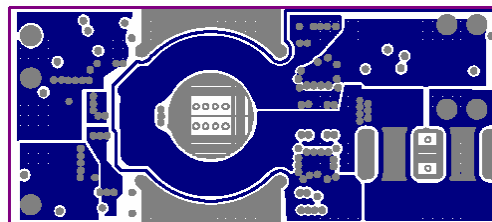

Layer #4

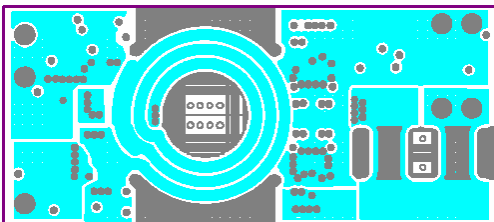

Layer #5

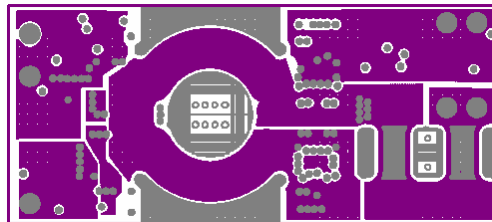

Layer #6

Note : The above Gerber file is available upon request

IRDC2085S-DF DC Bus Converter Demo Board BOM List

Item No	Ref. Designator	Description	Part Number	Value	Package	Vendor
1	IC1	Controller IC	IR2085S	100V, +/- 1.0A	SO8	IR
2	NM1, NM2	Single N-Channel Power MOSFET	IRF7493	80VN, 15mOhm	SO8	IR
3	NM3, NM4	Single N-Channel Power MOSFET	IRF6618	30VN, 2.2mOhm	DirectFET	IR
4	NM5	Dual N-Channel Power MOSFET	IRF9956	30VN, 100mOhm	SO8	IR
5	NM6	Dual N-Channel Power MOSFET	IRF7380	80VN, 73mOhm	SO8	IR
6	Db4	Dual Rectifier Diode	BAT54S	30V	SOT23	IR
7	D, Db3	Rectifier Diode	BAV16WDICT-ND	75V	SOD123	Digi-key
8	Db1, Db6	Zener Diode	BZT52C15SDICT-ND	15V	SOD323	Digi-key
9	Db2	Zener Diode	BZT52C9V1SDICT-ND	9V	SOD323	Digi-key
10	Db5	Zener Diode	BZT52V3V0SDICT-ND	3V	SOD323	Digi-key
11	C1, C2	Ceramic cap	THCR50E1H335ZT	3.3u, 50V	1812	Digi-key
12	C3	Ceramic cap	ECJ5YB2A105M	1u, 100V	1812	Panasonic
13	C7, C8	Ceramic cap	GRM43E61C226KE01B	22u, 16V	1210	Digi-key
14	CB1,CB2	Ceramic cap	PCC1840CT-ND	0.1u, 25V	805	Digi-key
15	C4,C5	Ceramic cap	PCC2224CT-ND	1u, 16V	805	Digi-key
16	C6	Ceramic cap	PCC1470ACVCT-ND	47pf	603	Digi-key
17	Rg3, Rg4	Resistor	P10KGCT	10K	603	Digi-key
18	Rb9, Rb10	Resistor	P39KACT	39K	805	Digi-key
19	R	Resistor	P51KGCT	51K	603	Digi-key
20	Rg2	Resistor	P100KGCT	100K	603	Digi-key
21	Rb1, Rb2	Resistor	P200ECT	200	1206	Digi-key
22	Tr_a, Tr_	PQ Transformer Core, grinded	PQ20/16-3F3	Window width = 2.4mm grinded		Feroxube
23	2.4 mil Gap	PQ core center gaped(cut to fit) material	200FN919	Kapton Polyimide Film		Dupont
24	Lo_a	Inductor Core, non-gaped half	E14/3.5/5-3F3			Feroxube
25	Lo_a	Inductor Core, gapped half	E14/3.5/5-3F3-A160-E			Feroxube
26	PCB	PCB (8 layers: 3 Oz Cu top & bottom layers, 4 Oz Cu center layers, 2.125"x0.8125")				
27	Tab	For input & output connection	3125-2-00-01-00-00-08-0			Mill-Max
28	Connector	Banana Jack, Insulated Nylon, Red & Black	J151-ND			Digi-key