

## LM4897 Boomer® Audio Power Amplifier Series 1.1 Watt Audio Power Amplifier with Fade-In and Fade-Out

Check for Samples: [LM4897](#)

### FEATURES

- No Output Coupling Capacitors, Snubber Networks or Bootstrap Capacitors Required
- Unity Gain Stable
- Ultra Low Current Shutdown Mode
- Fade-In/Fade-Out
- BTL Output Can Drive Capacitive Loads up to 100pF
- Advanced Pop and Click Circuitry Eliminates Noises During Turn-On and Turn-Off Transitions
- 2.6V - 5.5V Operation
- Available in a Space-Saving SOIC Package

### KEY SPECIFICATIONS

- Improved PSRR at 5V, 3V, & 217Hz: 62dB (typ)
- Higher  $P_O$  at 5V, THD+N = 1%: 1.1W (typ)
- Higher  $P_O$  at 3V, THD+N = 1%: 350mW (typ)
- Shutdown Current: 0.1 $\mu$ A (typ)

### APPLICATIONS

- Mobile Phones
- PDAs
- Portable Electronic Devices

### Connection Diagrams

Mini Small Outline (VSSOP) Package

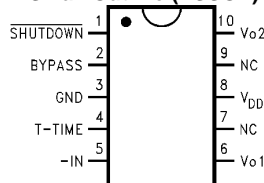

Figure 1. Top View  
See package Number DGS0010A

### DESCRIPTION

The LM4897 is an audio power amplifier primarily designed for demanding applications in mobile phones and other portable communication device applications. It is capable of delivering 1.1W of continuous average power to an 8 $\Omega$  BTL load with less than 1% distortion (THD+N) from a +5V<sub>DC</sub> power supply.

The LM4897 contains advanced pop and click circuitry that eliminate noises which would otherwise occur during turn-on and turn-off transitions. It also contains a fade-in/fade-out feature that eliminates unnatural sound generated by asserting/de-asserting the SHUTDOWN pin. The LM4897 is unity-gain stable and can be configured by external gain-setting resistors.

The LM4897 features a low-power consumption global shutdown mode, which is achieved by driving the shutdown pin with logic low. Additionally, the LM4897 features an internal thermal shutdown protection mechanism.

Boomer audio power amplifiers were designed specifically to provide high quality output power with a minimal amount of external components. The LM4897 does not require output coupling capacitors or bootstrap capacitors, and therefore is ideally suited for lower-power portable applications where minimal space and power consumption are primary requirements.



Please be aware that an important notice concerning availability, standard warranty, and use in critical applications of Texas Instruments semiconductor products and disclaimers thereto appears at the end of this data sheet.

All trademarks are the property of their respective owners.

## Typical Application

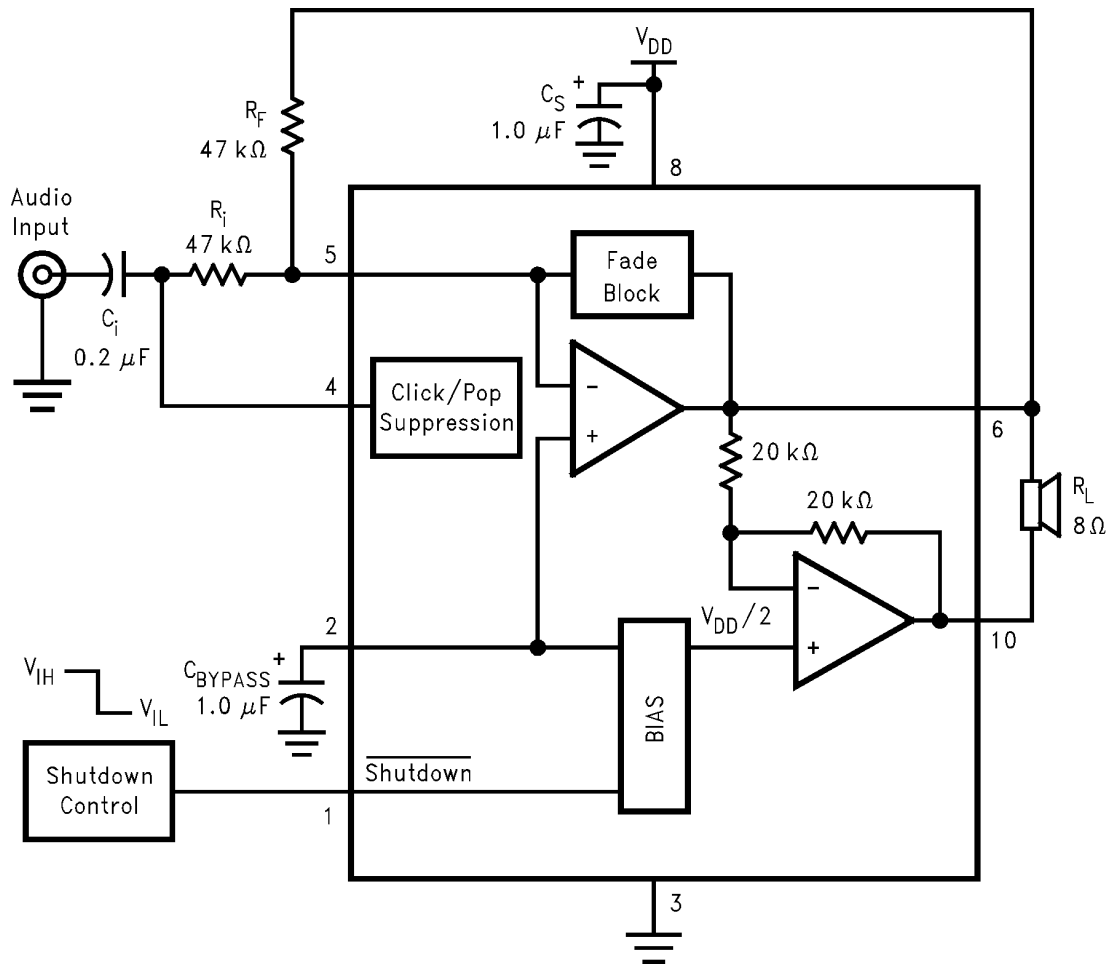

Figure 2. Typical Audio Amplifier Application Circuit



These devices have limited built-in ESD protection. The leads should be shorted together or the device placed in conductive foam during storage or handling to prevent electrostatic damage to the MOS gates.

### Absolute Maximum Ratings<sup>(1)(2)</sup>

Supply Voltage	6.0V
Storage Temperature	-65°C to +150°C
Input Voltage	-0.3V to $V_{DD} + 0.3V$
Power Dissipation <sup>(3)</sup>	Internally Limited
ESD Susceptibility <sup>(4)</sup>	2000V
ESD Susceptibility <sup>(5)</sup>	200V
Junction Temperature	150°C
Thermal Resistance	
$\theta_{JC}$ (DGS0010A)	56°C/W
$\theta_{JA}$ (DGS0010A)	190°C/W

- (1) [Absolute Maximum Ratings](#) indicate limits beyond which damage to the device may occur. [Operating Ratings](#) indicate conditions for which the device is functional, but do not ensure specific performance limits. Electrical Characteristics state DC and AC electrical specifications under particular test conditions which specify performance limits. This assumes that the device is within the [Operating Ratings](#). Specifications are not ensured for parameters where no limit is given, however, the typical value is a good indication of device performance.
- (2) If Military/Aerospace specified devices are required, please contact the Texas Instruments Sales Office/ Distributors for availability and specifications.
- (3) The maximum power dissipation must be derated at elevated temperatures and is dictated by  $T_{JMAX}$ ,  $\theta_{JA}$ , and the ambient temperature  $T_A$ . The maximum allowable power dissipation is  $P_{DMAX} = (T_{JMAX} - T_A) / \theta_{JA}$  or the number given in [Absolute Maximum Ratings](#), whichever is lower. For the LM4897, see power derating curves (in the [Typical Performance Characteristics](#) section) for additional information.
- (4) Human body model, 100pF discharged through a 1.5k $\Omega$  resistor.
- (5) Machine Model, 220pF–240pF discharged through all pins.

### Operating Ratings

Temperature Range	
$T_{MIN} \leq T_A \leq T_{MAX}$	-40°C $\leq$ $T_A$ $\leq$ 85°C
Supply Voltage	2.6V $\leq$ $V_{DD}$ $\leq$ 5.5V

### Electrical Characteristics $V_{DD} = 5.0V^{(1)(2)}$

The following specifications apply for the circuit shown in [Figure 2](#) unless otherwise specified. Limits apply for  $T_A = 25^\circ C$ .

Symbol	Parameter	Conditions	LM4897		Units (Limits)
			Typical <sup>(3)</sup>	Limit <sup>(4)(5)</sup>	
$I_{DD}$	Quiescent Power Supply Current	$V_{IN} = 0V$ , 8 $\Omega$ BTL	5	9	mA (max)
$I_{SD}$	Shutdown Current	$V_{shutdown} = GND$	0.1	2	$\mu A$ (max)
$V_{OS}$	Output Offset Voltage		4	30	mV (max)
$P_o$	Output Power	THD+N = 1% (max), $f = 1kHz$	1.1	0.9	W (min)
THD+N	Total Harmonic Distortion+Noise	$P_o = 0.4W_{rms}$ , $f = 1kHz$	0.1		%
PSRR	Power Supply Rejection Ratio	$V_{ripple} = 200mV_{pp}$ sine wave, $C_B = 1.0\mu F$ Input terminated with 10 $\Omega$ to GND	63 ( $f = 1kHz$ ) 62 ( $f = 217Hz$ )	55 55	dB (min)
$V_{SDIH}$	Shutdown High Input Voltage			1.4	V (min)
$V_{SDIL}$	Shutdown Low Input Voltage			0.4	V (max)
$V_{ON}$	Output Noise	A-Weighted, Measured across 8 $\Omega$ BTL Input terminated with 10 $\Omega$ to ground	26		$\mu V_{RMS}$
$T_{ON}$	Turn-On Time	$C_{BYPASS} = 1\mu F$	25	35	ms (max)

- (1) All voltages are measured with respect to the ground pin, unless otherwise specified.
- (2) [Absolute Maximum Ratings](#) indicate limits beyond which damage to the device may occur. [Operating Ratings](#) indicate conditions for which the device is functional, but do not ensure specific performance limits. Electrical Characteristics state DC and AC electrical specifications under particular test conditions which specify performance limits. This assumes that the device is within the [Operating Ratings](#). Specifications are not ensured for parameters where no limit is given, however, the typical value is a good indication of device performance.
- (3) Typicals are measured at 25°C and represent the parametric norm.
- (4) Limits are specified to AOQL (Average Outgoing Quality Level).
- (5) Exposure to direct sunlight will increase  $I_{SD}$  by a maximum of 2 $\mu A$ .

### Electrical Characteristics $V_{DD} = 3.0V^{(1)(2)}$

The following specifications apply for the circuit shown in [Figure 2](#) unless otherwise specified. Limits apply for  $T_A = 25^\circ C$ .

Symbol	Parameter	Conditions	LM4897		Units (Limits)
			Typical <sup>(3)</sup>	Limit <sup>(4)(5)</sup>	
$I_{DD}$	Quiescent Power Supply Current	$V_{IN} = 0V$ , 8 $\Omega$ BTL	4	8	mA (max)
$I_{SD}$	Shutdown Current	$V_{shutdown} = GND$	0.1	2	$\mu A$ (max)
$P_o$	Output Power	THD+N = 1% (max), $f = 1kHz$	350	320	mW (min)
$V_{OS}$	Output Offset Voltage		4	30	mV (max)
THD+N	Total Harmonic Distortion+Noise	$P_o = 0.15W_{rms}$ , $f = 1kHz$	0.1		%
PSRR	Power Supply Rejection Ratio	$V_{ripple} = 200mV_{pp}$ sine wave, $C_B = 1.0\mu F$ Input terminated with 10 $\Omega$ to ground	63 ( $f = 1kHz$ ) 62 ( $f = 217Hz$ )	55 55	dB (min)
$V_{SDIH}$	Shutdown High Input Voltage			1.4	V (min)
$V_{SDIL}$	Shutdown Low Input Voltage			0.4	V (max)
$V_{ON}$	Output Voltage Noise	A-Weighted, Measured across 8 $\Omega$ BTL Input terminated with 10 $\Omega$ to ground	26		$\mu V_{RMS}$

- (1) All voltages are measured with respect to the ground pin, unless otherwise specified.
- (2) [Absolute Maximum Ratings](#) indicate limits beyond which damage to the device may occur. [Operating Ratings](#) indicate conditions for which the device is functional, but do not ensure specific performance limits. Electrical Characteristics state DC and AC electrical specifications under particular test conditions which specify performance limits. This assumes that the device is within the [Operating Ratings](#). Specifications are not ensured for parameters where no limit is given, however, the typical value is a good indication of device performance.
- (3) Typicals are measured at 25°C and represent the parametric norm.
- (4) Limits are specified to AOQL (Average Outgoing Quality Level).
- (5) Exposure to direct sunlight will increase  $I_{SD}$  by a maximum of 2 $\mu A$ .

## Electrical Characteristics $V_{DD} = 2.6V^{(1)(2)(3)(4)(5)}$

The following specifications apply for the circuit shown in [Figure 2](#) unless otherwise specified. Limits apply for  $T_A = 25^\circ C$ .

Symbol	Parameter	Conditions	LM4897		Units (Limits)
			Typical <sup>(6)</sup>	Limit <sup>(7)(8)</sup>	
$I_{DD}$	Quiescent Power Supply Current	$V_{IN} = 0V, 8\Omega$ BTL	3.5	7	mA (max)
$I_{SD}$	Shutdown Current	$V_{shutdown} = GND$	0.1	2	$\mu A$ (max)
$V_{OS}$	Output Offset Voltage		4	30	mV (max)
$P_o$	Output Power	THD+N = 1% (max), $f = 1kHz$			mW (min)
		$R_L = 8\Omega$	250		
THD+N	Total Harmonic Distortion+Noise	$P_o = 0.1W_{rms}, f = 1kHz$	0.1		%
PSRR	Power Supply Rejection Ratio	$V_{ripple} = 200mV_{pp}$ sine wave, $C_B = 1.0\mu F$ Input terminated with $10\Omega$ to GND	55 ( $f = 1kHz$ ) 55 ( $f = 217Hz$ )		dB

- (1) All voltages are measured with respect to the ground pin, unless otherwise specified.
- (2) [Absolute Maximum Ratings](#) indicate limits beyond which damage to the device may occur. [Operating Ratings](#) indicate conditions for which the device is functional, but do not ensure specific performance limits. Electrical Characteristics state DC and AC electrical specifications under particular test conditions which specify performance limits. This assumes that the device is within the [Operating Ratings](#). Specifications are not ensured for parameters where no limit is given, however, the typical value is a good indication of device performance.
- (3) If the product is in shutdown mode, and  $V_{DD}$  exceeds 6V (to a max of  $8V V_{DD}$ ), then most of the excess current will flow through the ESD protection circuits. If the source impedance limits the current to a max of 10ma, then the part will be protected. If the part is enabled when  $V_{DD}$  is above 6V, circuit performance will be curtailed or the part may be permanently damaged.
- (4) All bumps have the same thermal resistance and contribute equally when used to lower thermal resistance.
- (5) Maximum power dissipation ( $P_{DMAX}$ ) in the device occurs at an output power level significantly below full output power.  $P_{DMAX}$  can be calculated using [APPLICATION INFORMATION](#) shown in the [APPLICATION INFORMATION](#) section. It may also be obtained from the power dissipation graphs.
- (6) Typical values are measured at  $25^\circ C$  and represent the parametric norm.
- (7) Limits are specified to AOQL (Average Outgoing Quality Level).
- (8) Exposure to direct sunlight will increase  $I_{SD}$  by a maximum of  $2\mu A$ .

## External Components Description

(See [Figure 2](#))

Components	Functional Description
1. $R_i$	Inverting input resistance which sets the closed-loop gain in conjunction with $R_f$ . This resistor also forms a high pass filter with $C_i$ at $f_C = 1/(2\pi R_i C_i)$ .
2. $C_i$	Input coupling capacitor which blocks the DC voltage at the amplifiers input terminals. Also creates a highpass filter with $R_i$ at $f_C = 1/(2\pi R_i C_i)$ . Refer to the section, <a href="#">Proper Selection of External Components</a> , for an explanation of how to determine the value of $C_i$ .
3. $R_f$	Feedback resistance which sets the closed-loop gain in conjunction with $R_i$ .
4. $C_S$	Supply bypass capacitor which provides power supply filtering. Refer to the <a href="#">Power Supply Bypassing</a> section for information concerning proper placement and selection of the supply bypass capacitor.
5. $C_B$	Bypass pin capacitor which provides half-supply filtering. Refer to the section, <a href="#">Proper Selection of External Components</a> , for information concerning proper placement and selection of $C_B$ .

**TYPICAL PERFORMANCE CHARACTERISTICS**

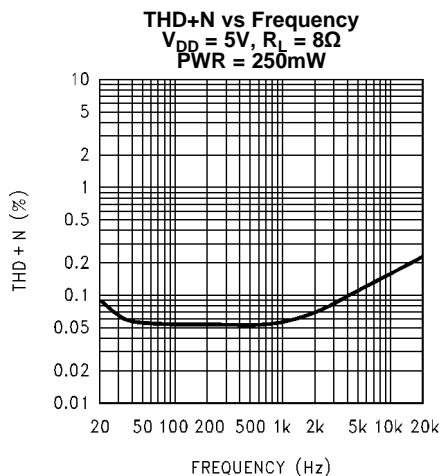

Figure 3.

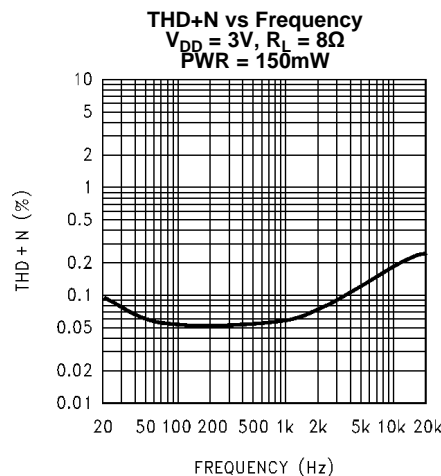

Figure 4.

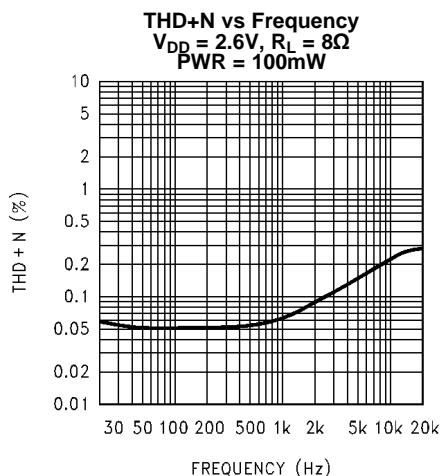

Figure 5.

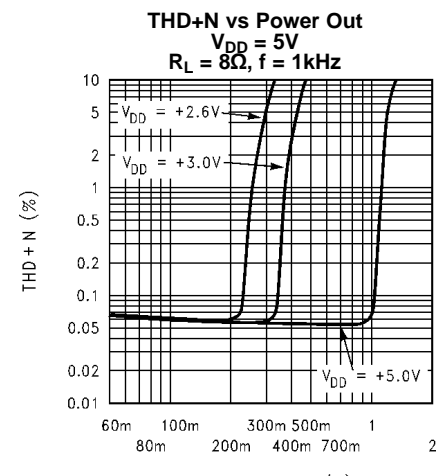

Figure 6.

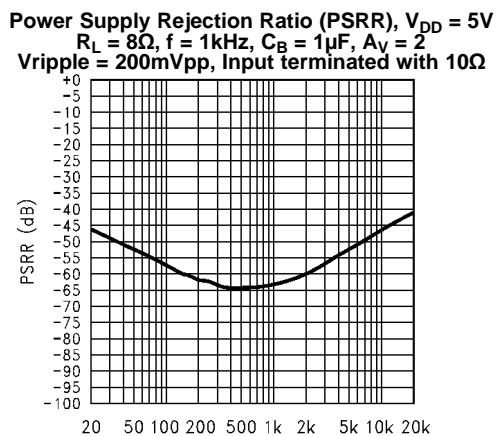

Figure 7.

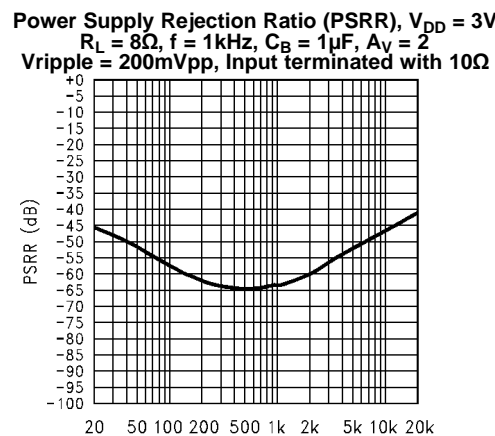

Figure 8.

**TYPICAL PERFORMANCE CHARACTERISTICS (continued)**

**Power Supply Rejection Ratio (PSRR),  $V_{DD} = 2.6V$**   
 $R_L = 8\Omega$ ,  $f = 1kHz$ ,  $C_B = 1\mu F$ ,  $A_V = 2$   
 Ripple = 200mVpp, Input terminated with  $10\Omega$

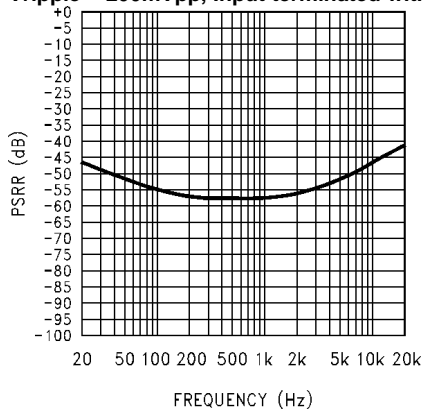

Figure 9.

**Power Dissipation vs Output Power**  
 $V_{DD} = 5V$ ,  $R_L = 8\Omega$ ,  $f = 1kHz$   
 $THD+N \leq 1.0\%$ ,  $BW < 80kHz$

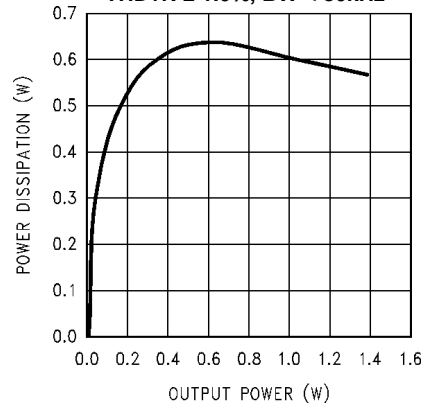

Figure 10.

**Power Dissipation vs Output Power**  
 $V_{DD} = 3V$ ,  $R_L = 8\Omega$ ,  $f = 1kHz$   
 $THD+N \leq 1.0\%$ ,  $BW < 80kHz$

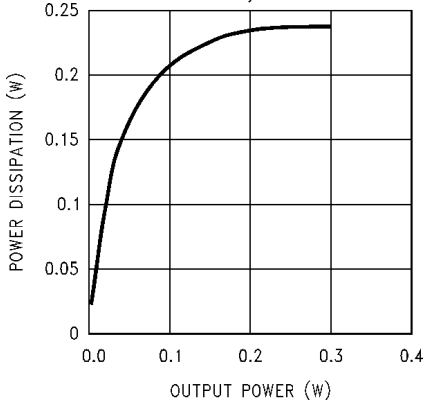

Figure 11.

**Power Dissipation vs Output Power**  
 $V_{DD} = 2.6V$ ,  $f = 1kHz$   
 $THD+N \leq 1.0\%$ ,  $BW < 80kHz$

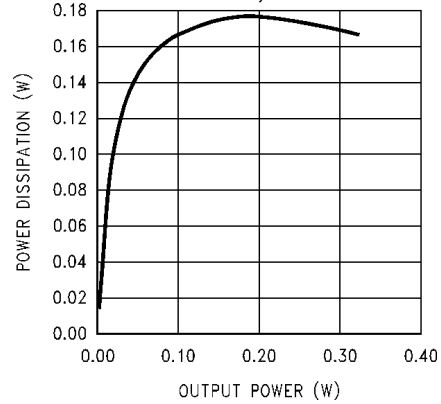

Figure 12.

**Power Derating - VSSOP  $P_{DMAX} = 670mW$**   
 $V_{DD} = 5V$ ,  $R_L = 8\Omega$

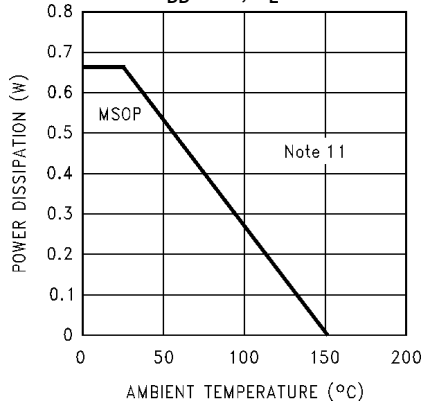

Figure 13.

**Output Power vs Supply Voltage**

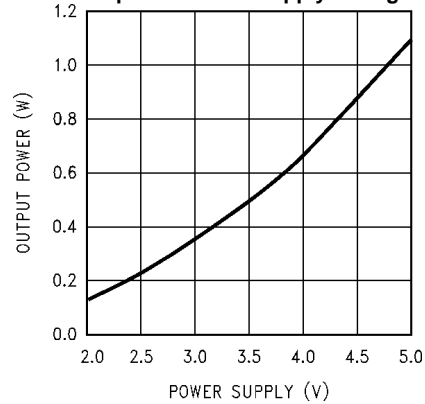

Figure 14.

**TYPICAL PERFORMANCE CHARACTERISTICS (continued)**

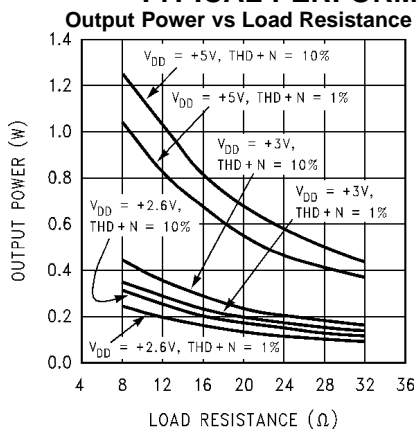

Figure 15.

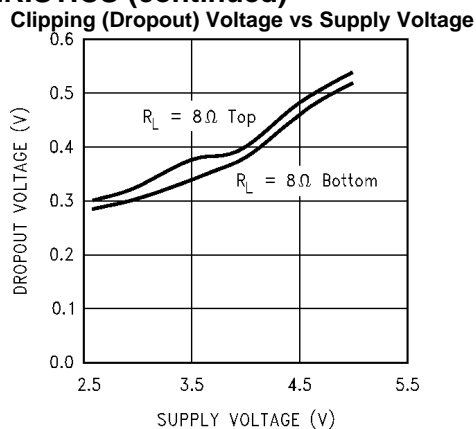

Figure 16.

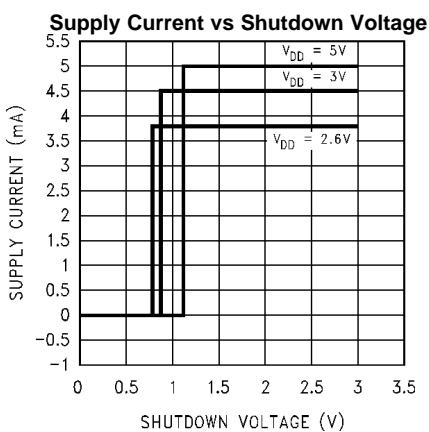

Figure 17.

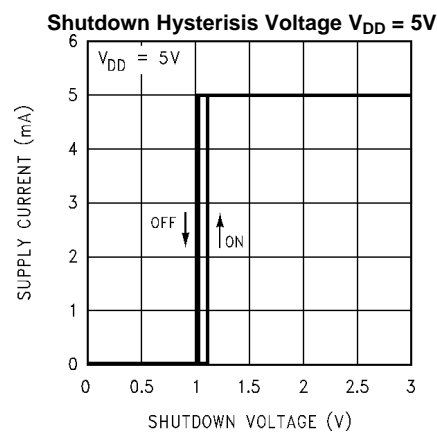

Figure 18.

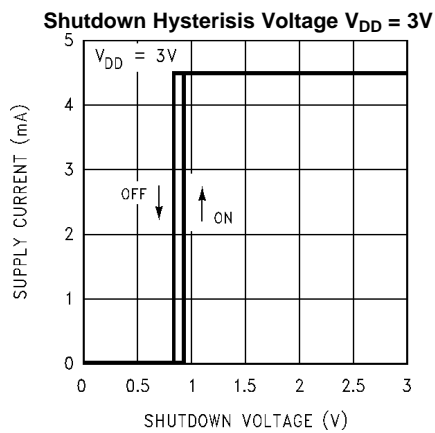

Figure 19.

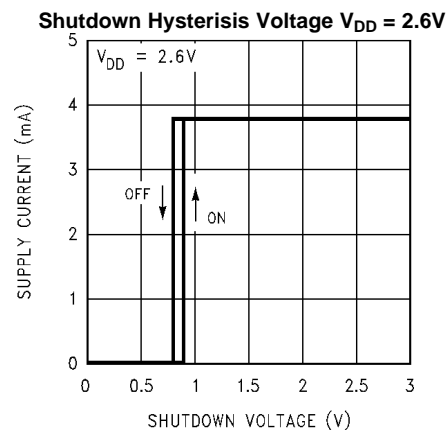

Figure 20.



**TYPICAL PERFORMANCE CHARACTERISTICS (continued)**

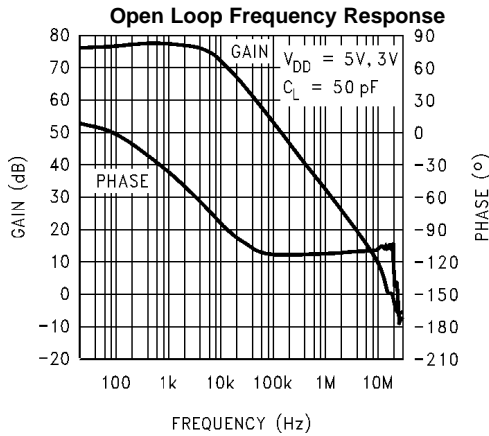

Figure 21.

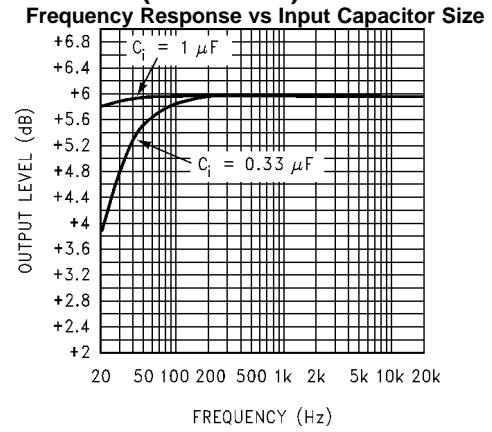

Figure 22.

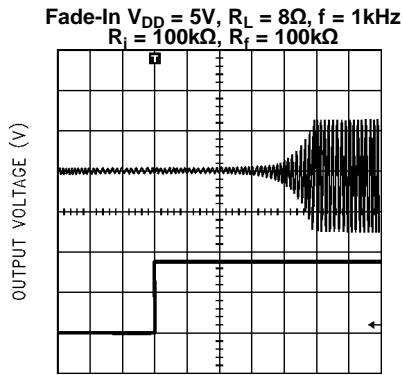

Figure 23.

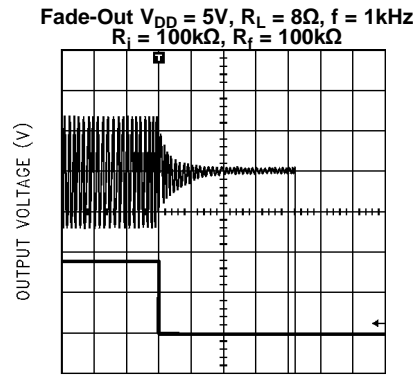

Figure 24.

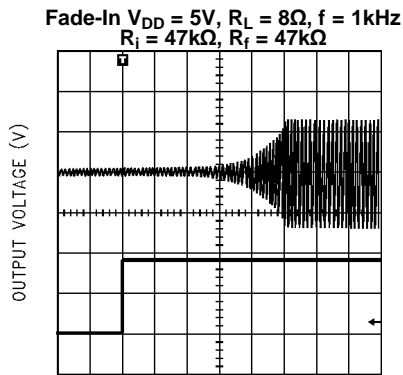

Figure 25.

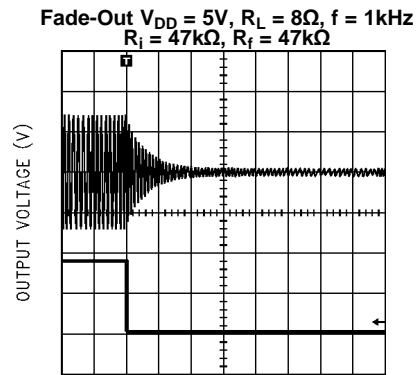
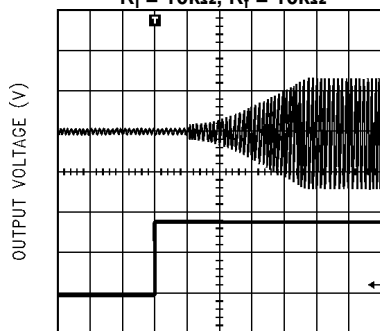

Figure 26.

### TYPICAL PERFORMANCE CHARACTERISTICS (continued)

Fade-In  $V_{DD} = 5V$ ,  $R_L = 8\Omega$ ,  $f = 1kHz$   
 $R_i = 10k\Omega$ ,  $R_f = 10k\Omega$



TIME (ms)  
**Figure 27.**

Fade-Out  $V_{DD} = 5V$ ,  $R_L = 8\Omega$ ,  $f = 1kHz$   
 $R_i = 10k\Omega$ ,  $R_f = 10k\Omega$

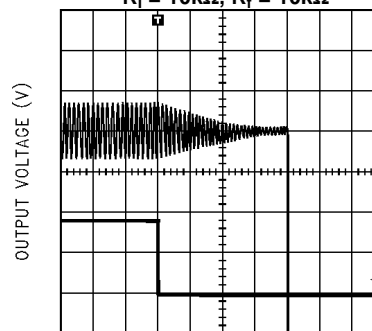

TIME (ms)  
**Figure 28.**

Fade-In  $V_{DD} = 5V$ ,  $R_L = 8\Omega$ ,  $f = 1kHz$   
 $R_i = 9.4k\Omega$ ,  $R_f = 47k\Omega$

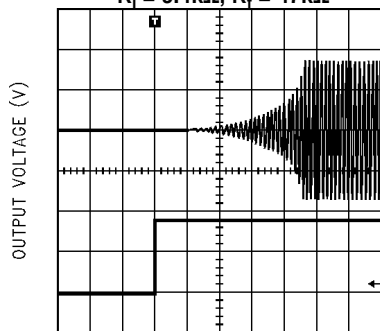

TIME (ms)  
**Figure 29.**

Fade-Out  $V_{DD} = 5V$ ,  $R_L = 8\Omega$ ,  $f = 1kHz$   
 $R_i = 9.4k\Omega$ ,  $R_f = 47k\Omega$

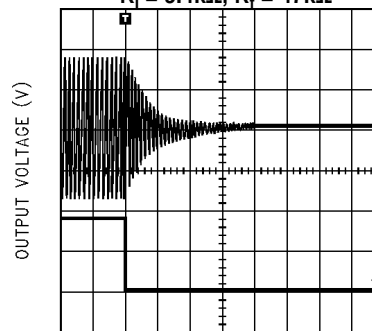

TIME (ms)  
**Figure 30.**

## APPLICATION INFORMATION

### BRIDGE CONFIGURATION EXPLANATION

As shown in [Figure 2](#), the LM4897 has two operational amplifiers internally, allowing for a few different amplifier configurations. The first amplifier's gain is externally configurable, while the second amplifier is internally fixed in a unity-gain, inverting configuration. The closed-loop gain of the first amplifier is set by selecting the ratio of  $R_f$  to  $R_i$  while the second amplifier's gain is fixed by the two internal 20k $\Omega$  resistors. [Figure 2](#) shows that the output of amplifier one serves as the input to amplifier two which results in both amplifiers producing signals identical in magnitude, but out of phase by 180°. Consequently, the differential gain for the IC is:

$$A_{VD} = 2 \times (R_f/R_i) \quad (1)$$

By driving the load differentially through outputs Vo1 and Vo2, an amplifier configuration commonly referred to as “bridged mode” is established. Bridged mode operation is different from the classical single-ended amplifier configuration where one side of the load is connected to ground.

A bridge amplifier design has a few distinct advantages over the single-ended configuration, as it provides differential drive to the load, thus doubling output swing for a specified supply voltage. Four times the output power is possible as compared to a single-ended amplifier under the same conditions. This increase in attainable output power assumes that the amplifier is not current limited or clipped. In order to choose an amplifier's closed-loop gain without causing excessive clipping, please refer to the [Audio Power Amplifier Design](#) section.

A bridge configuration, such as the one used in LM4897, also creates a second advantage over single-ended amplifiers. Since the differential outputs, Vo1 and Vo2, are biased at half-supply, no net DC voltage exists across the load. This eliminates the need for an output coupling capacitor which is required in a single supply, single-ended amplifier configuration. Without an output coupling capacitor, the half-supply bias across the load would result in both increased internal IC power dissipation and also possible loudspeaker damage.

### POWER DISSIPATION

Power dissipation is a major concern when designing a successful amplifier, whether the amplifier is bridged or single-ended. A direct consequence of the increased power delivered to the load by a bridge amplifier is an increase in internal power dissipation. Since the LM4897 has two operational amplifiers in one package, the maximum internal power dissipation is 4 times that of a single-ended amplifier. The maximum power dissipation for a given application can be derived from the power dissipation graphs or from [Equation 2](#):

$$P_{DMAX} = 4 \times (V_{DD})^2 / (2\pi^2 R_L) \quad (2)$$

It is critical that the maximum junction temperature ( $T_{JMAX}$ ) of 150°C is not exceeded.  $T_{JMAX}$  can be determined from the power derating curves by using  $P_{DMAX}$  and the PC board foil area. By adding additional copper foil, the thermal resistance of the application can be reduced from a free air value of 150°C/W, resulting in higher  $P_{DMAX}$ . Additional copper foil can be added to any of the leads connected to the LM4897. It is especially effective when connected to  $V_{DD}$ , GND, and the output pins. Refer to the application information on the LM4897 reference design board for an example of good heat sinking. If  $T_{JMAX}$  still exceeds 150°C, then additional changes must be made. These changes can include reduced supply voltage, higher load impedance, or reduced ambient temperature. Internal power dissipation is a function of output power. Refer to the [Typical Performance Characteristics](#) curves for power dissipation information for different output powers and output loading.

### POWER SUPPLY BYPASSING

As with any amplifier, proper supply bypassing is critical for low noise performance and high power supply rejection. The capacitor location on both the bypass and power supply pins should be as close to the device as possible. Typical applications employ a 5V regulator with 10 $\mu$ F tantalum or electrolytic capacitor and a ceramic bypass capacitor which aid in supply stability. This does not eliminate the need for bypassing the supply nodes of the LM4897. The selection of a bypass capacitor, especially  $C_B$ , is dependent upon PSRR requirements, click and pop performance (as explained in the section, [Proper Selection of External Components](#)), system cost, and size constraints.

## SHUTDOWN FUNCTION

In order to reduce power consumption while not in use, the LM4897 contains a shutdown pin to externally turn off the amplifier's bias circuitry. This shutdown feature turns the amplifier off when a logic low is placed on the shutdown pin. By switching the shutdown pin to ground, the LM4897 supply current draw will be minimized in idle mode. While the device will be disabled with shutdown pin voltages less than  $0.4V_{DC}$ , the idle current may be greater than the typical value of  $0.1\mu A$ . (Idle current is measured with the shutdown pin tied to ground).

In many applications, a microcontroller or microprocessor output is used to control the shutdown circuitry to provide a quick, smooth transition into shutdown. Another solution is to use a single-pole, single-throw switch in conjunction with an external pull-up resistor. When the switch is closed, the shutdown pin is connected to ground which disables the amplifier. If the switch is open, then the external pull-up resistor to  $V_{DD}$  will enable the LM4897. This scheme ensures that the shutdown pin will not float thus preventing unwanted state changes.

## PROPER SELECTION OF EXTERNAL COMPONENTS

Proper selection of external components in applications using integrated power amplifiers is critical to optimize device and system performance. While the LM4897 is tolerant of external component combinations, consideration to component values must be used to maximize overall system quality.

The LM4897 is unity-gain stable which gives the designer maximum system flexibility. The LM4897 should be used in low gain configurations to minimize THD+N values, and maximize the signal to noise ratio. Low gain configurations require large input signals to obtain a given output power. Input signals equal to or greater than  $1 V_{rms}$  are available from sources such as audio codecs. Please refer to the section, [Audio Power Amplifier Design](#), for a more complete explanation of proper gain selection.

Besides gain, one of the major considerations is the closed-loop bandwidth of the amplifier. To a large extent, the bandwidth is dictated by the choice of external components shown in [Figure 2](#). The input coupling capacitor,  $C_i$ , forms a first order high pass filter which limits low frequency response. This value should be chosen based on needed frequency response for a few distinct reasons.

### Selection Of Input Capacitor Size

Large input capacitors are both expensive and space hungry for portable designs. Clearly, a certain sized capacitor is needed to couple in low frequencies without severe attenuation. But in many cases the speakers used in portable systems, whether internal or external, have little ability to reproduce signals below 100Hz to 150Hz. Thus, using a large input capacitor may not increase actual system performance.

In addition to system cost and size, click and pop performance is effected by the size of the input coupling capacitor,  $C_i$ . A larger input coupling capacitor requires more charge to reach its quiescent DC voltage (nominally  $1/2 V_{DD}$ ). This charge comes from the output via the feedback and is apt to create pops upon device enable. Thus, by minimizing the capacitor size based on necessary low frequency response, turn-on pops can be minimized.

Besides minimizing the input capacitor size, careful consideration should be paid to the bypass capacitor value. Bypass capacitor,  $C_B$ , is the most critical component to minimize turn-on pops since it determines how fast the LM4897 turns on. The slower the LM4897's outputs ramp to their quiescent DC voltage (nominally  $1/2 V_{DD}$ ), the smaller the turn-on pop. Choosing  $C_B$  equal to  $1.0\mu F$  along with a small value of  $C_i$  (in the range of  $0.1\mu F$  to  $0.39\mu F$ ), should produce a virtually clickless and popless shutdown function. While the device will function properly, (no oscillations or motorboating), with  $C_B$  equal to  $0.1\mu F$ , the device will be much more susceptible to turn-on clicks and pops. Thus, a value of  $C_B$  equal to  $1.0\mu F$  is recommended in all but the most cost sensitive designs.

## AUDIO POWER AMPLIFIER DESIGN

### A 1W/8Ω Audio Amplifier

Given:	
Power Output	1 Wrms
Load Impedance	8Ω
Input Level	1 Vrms
Input Impedance	20kΩ
Bandwidth	100Hz – 20kHz ± 0.2 dB

A designer must first determine the minimum supply rail to obtain the specified output power. By extrapolating from the Output Power vs Supply Voltage graphs in the [Typical Performance Characteristics](#) section, the supply rail can be easily found. A second way to determine the minimum supply rail is to calculate the required  $V_{\text{opeak}}$  using [Equation 2](#) and add the output voltage. Using this method, the minimum supply voltage would be:

$$(V_{\text{opeak}} + (V_{\text{ODTOP}} + V_{\text{ODBOT}}))$$

where

- $V_{\text{ODBOT}}$  and  $V_{\text{ODTOP}}$  are extrapolated from the Dropout Voltage vs Supply Voltage curve (in the [Typical Performance Characteristics](#) section), and
- $V_{\text{opeak}} = \sqrt{(2R_L P_O)}$  (3)

5V is a standard voltage, in most applications, chosen for the supply rail. Extra supply voltage creates headroom that allows the LM4897 to reproduce peaks in excess of 1W without producing audible distortion. At this time, the designer must make sure that the power supply choice along with the output impedance does not violate the conditions explained in the [Power Dissipation](#) section.

Once the power dissipation equations have been addressed, the required differential gain can be determined from [Equation 4](#):

$$A_{VD} \geq \sqrt{(P_O R_L)} / (V_{IN}) = V_{\text{orms}} / V_{\text{inrms}}$$

where

- $A_{VD} = (R_f / R_i)^2$  (4)

From [Equation 4](#), the minimum  $A_{VD}$  is 2.83; use  $A_{VD} = 3$ .

Since the desired input impedance was 20kΩ, and with a  $A_{VD}$  of 3, a ratio of 1.5:1 of  $R_f$  to  $R_i$  results in an allocation of  $R_i = 20\text{k}\Omega$  and  $R_f = 30\text{k}\Omega$ . The final design step is to address the bandwidth requirements which must be stated as a pair of -3dB frequency points. Five times away from a -3dB point is 0.17dB down from passband response which is better than the required ±0.25dB specified:

$$f_L = 100\text{Hz} / 5 = 20\text{Hz} \quad (5)$$

$$f_H = 20\text{kHz} * 5 = 100\text{kHz} \quad (6)$$

As stated in the [External Components](#) section,  $R_i$  in conjunction with  $C_i$  create a highpass filter:

$$C_i \geq 1 / (2\pi * 20\text{k}\Omega * 20\text{Hz}) = 0.397\mu\text{F}; \text{ use } 0.39\mu\text{F} \quad (7)$$

The high frequency pole is determined by the product of the desired frequency pole,  $f_H$ , and the differential gain,  $A_{VD}$ . With a  $A_{VD} = 3$  and  $f_H = 100\text{kHz}$ , the resulting GBWP = 300kHz which is much smaller than the LM4897 GBWP of 10 MHz. This figure displays that if a designer has a need to design an amplifier with a higher differential gain, the LM4897 can still be used without running into bandwidth limitations.

LM4897 FADE-IN / FADE-OUT

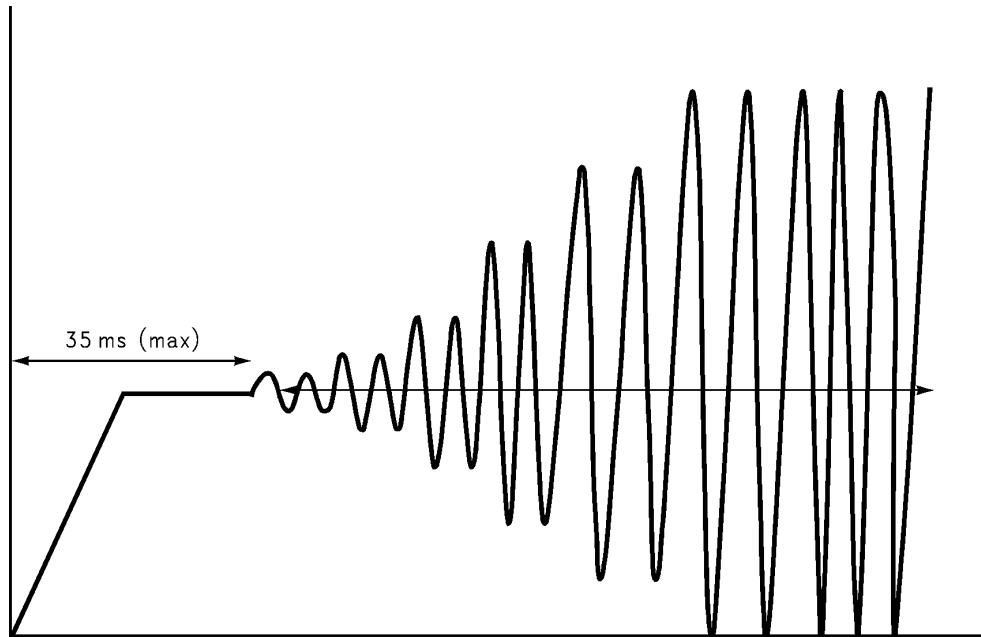

Figure 31. Fade-In Behavior

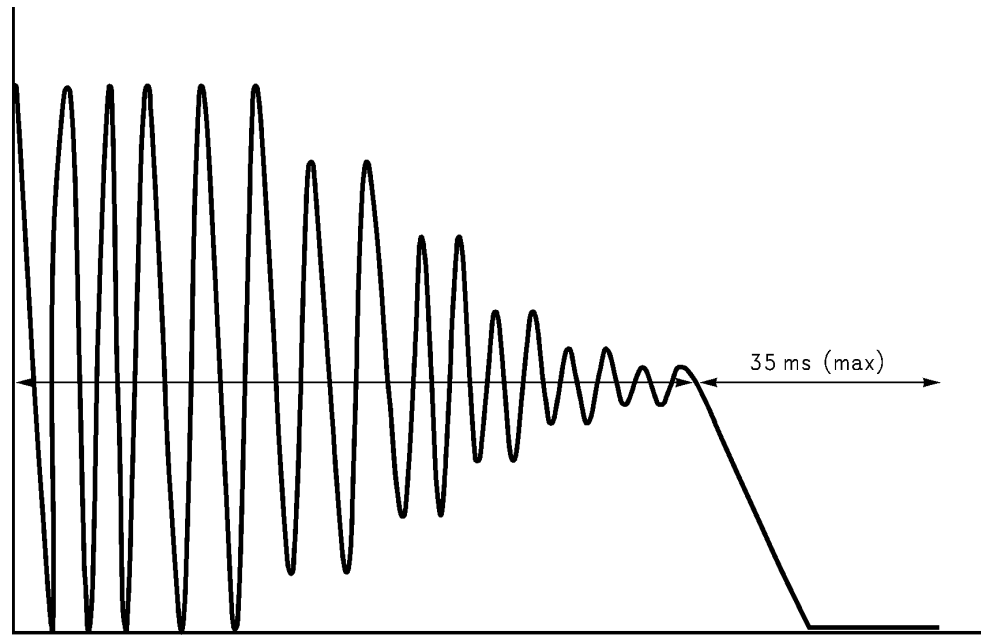

Figure 32. Fade-Out Behavior

LM4897 VSSOP DEMO BOARD ARTWORK

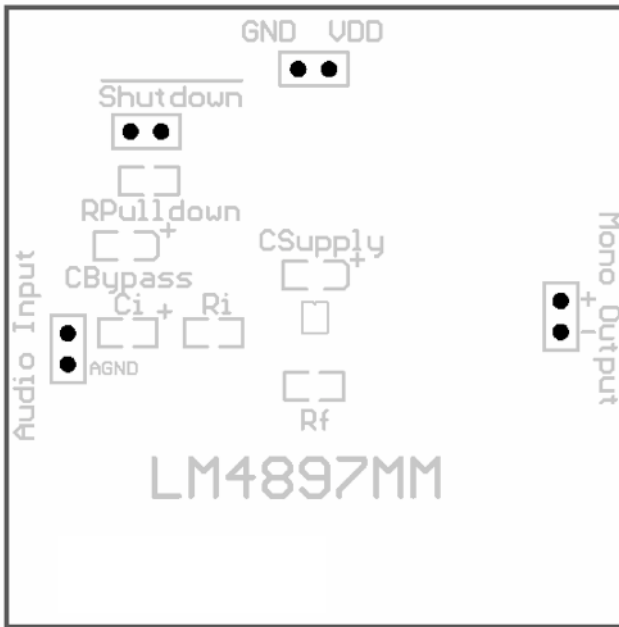

Figure 33. Top Overlay

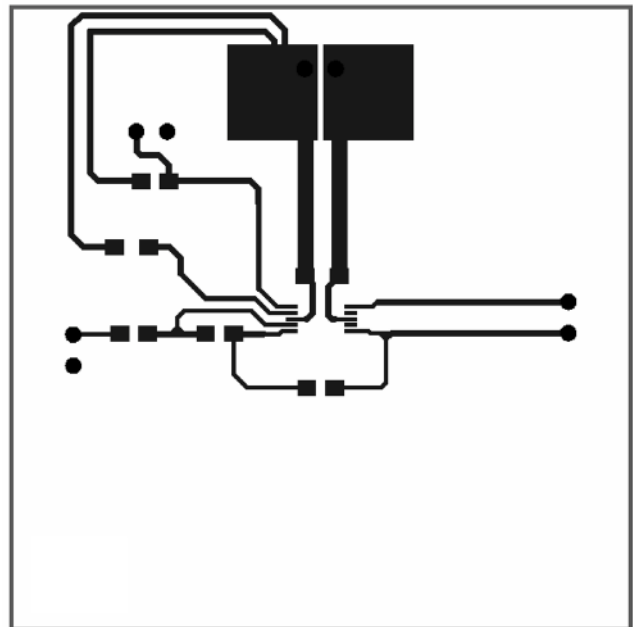

Figure 34. Top Layer

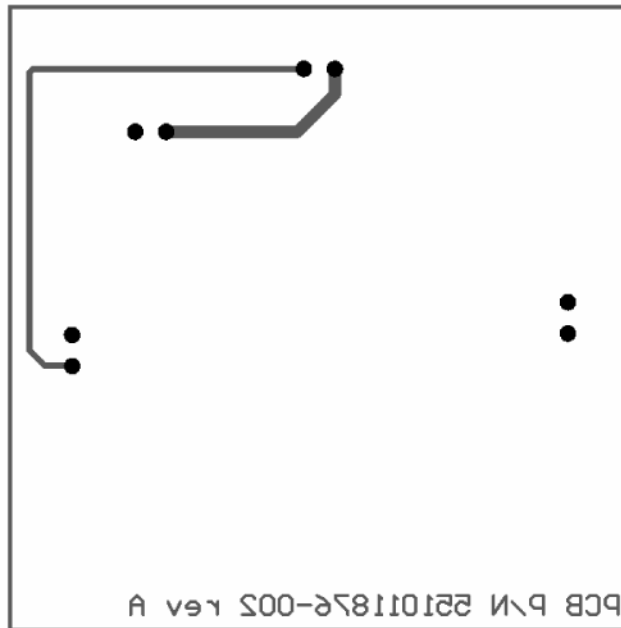

Figure 35. Bottom Layer

---

## REVISION HISTORY

Changes from Revision D (April 2013) to Revision E	Page
• Changed layout of National Data Sheet to TI format .....	<a href="#">15</a>

---



## IMPORTANT NOTICE

Texas Instruments Incorporated and its subsidiaries (TI) reserve the right to make corrections, enhancements, improvements and other changes to its semiconductor products and services per JESD46, latest issue, and to discontinue any product or service per JESD48, latest issue. Buyers should obtain the latest relevant information before placing orders and should verify that such information is current and complete. All semiconductor products (also referred to herein as "components") are sold subject to TI's terms and conditions of sale supplied at the time of order acknowledgment.

TI warrants performance of its components to the specifications applicable at the time of sale, in accordance with the warranty in TI's terms and conditions of sale of semiconductor products. Testing and other quality control techniques are used to the extent TI deems necessary to support this warranty. Except where mandated by applicable law, testing of all parameters of each component is not necessarily performed.

TI assumes no liability for applications assistance or the design of Buyers' products. Buyers are responsible for their products and applications using TI components. To minimize the risks associated with Buyers' products and applications, Buyers should provide adequate design and operating safeguards.

TI does not warrant or represent that any license, either express or implied, is granted under any patent right, copyright, mask work right, or other intellectual property right relating to any combination, machine, or process in which TI components or services are used. Information published by TI regarding third-party products or services does not constitute a license to use such products or services or a warranty or endorsement thereof. Use of such information may require a license from a third party under the patents or other intellectual property of the third party, or a license from TI under the patents or other intellectual property of TI.

Reproduction of significant portions of TI information in TI data books or data sheets is permissible only if reproduction is without alteration and is accompanied by all associated warranties, conditions, limitations, and notices. TI is not responsible or liable for such altered documentation. Information of third parties may be subject to additional restrictions.

Resale of TI components or services with statements different from or beyond the parameters stated by TI for that component or service voids all express and any implied warranties for the associated TI component or service and is an unfair and deceptive business practice. TI is not responsible or liable for any such statements.

Buyer acknowledges and agrees that it is solely responsible for compliance with all legal, regulatory and safety-related requirements concerning its products, and any use of TI components in its applications, notwithstanding any applications-related information or support that may be provided by TI. Buyer represents and agrees that it has all the necessary expertise to create and implement safeguards which anticipate dangerous consequences of failures, monitor failures and their consequences, lessen the likelihood of failures that might cause harm and take appropriate remedial actions. Buyer will fully indemnify TI and its representatives against any damages arising out of the use of any TI components in safety-critical applications.

In some cases, TI components may be promoted specifically to facilitate safety-related applications. With such components, TI's goal is to help enable customers to design and create their own end-product solutions that meet applicable functional safety standards and requirements. Nonetheless, such components are subject to these terms.

No TI components are authorized for use in FDA Class III (or similar life-critical medical equipment) unless authorized officers of the parties have executed a special agreement specifically governing such use.

Only those TI components which TI has specifically designated as military grade or "enhanced plastic" are designed and intended for use in military/aerospace applications or environments. Buyer acknowledges and agrees that any military or aerospace use of TI components which have **not** been so designated is solely at the Buyer's risk, and that Buyer is solely responsible for compliance with all legal and regulatory requirements in connection with such use.

TI has specifically designated certain components as meeting ISO/TS16949 requirements, mainly for automotive use. In any case of use of non-designated products, TI will not be responsible for any failure to meet ISO/TS16949.

### Products

Audio	<a href="http://www.ti.com/audio">www.ti.com/audio</a>
Amplifiers	<a href="http://amplifier.ti.com">amplifier.ti.com</a>
Data Converters	<a href="http://dataconverter.ti.com">dataconverter.ti.com</a>
DLP® Products	<a href="http://www.dlp.com">www.dlp.com</a>
DSP	<a href="http://dsp.ti.com">dsp.ti.com</a>
Clocks and Timers	<a href="http://www.ti.com/clocks">www.ti.com/clocks</a>
Interface	<a href="http://interface.ti.com">interface.ti.com</a>
Logic	<a href="http://logic.ti.com">logic.ti.com</a>
Power Mgmt	<a href="http://power.ti.com">power.ti.com</a>
Microcontrollers	<a href="http://microcontroller.ti.com">microcontroller.ti.com</a>
RFID	<a href="http://www.ti-rfid.com">www.ti-rfid.com</a>
OMAP Applications Processors	<a href="http://www.ti.com/omap">www.ti.com/omap</a>
Wireless Connectivity	<a href="http://www.ti.com/wirelessconnectivity">www.ti.com/wirelessconnectivity</a>

### Applications

Automotive and Transportation	<a href="http://www.ti.com/automotive">www.ti.com/automotive</a>
Communications and Telecom	<a href="http://www.ti.com/communications">www.ti.com/communications</a>
Computers and Peripherals	<a href="http://www.ti.com/computers">www.ti.com/computers</a>
Consumer Electronics	<a href="http://www.ti.com/consumer-apps">www.ti.com/consumer-apps</a>
Energy and Lighting	<a href="http://www.ti.com/energy">www.ti.com/energy</a>
Industrial	<a href="http://www.ti.com/industrial">www.ti.com/industrial</a>
Medical	<a href="http://www.ti.com/medical">www.ti.com/medical</a>
Security	<a href="http://www.ti.com/security">www.ti.com/security</a>
Space, Avionics and Defense	<a href="http://www.ti.com/space-avionics-defense">www.ti.com/space-avionics-defense</a>
Video and Imaging	<a href="http://www.ti.com/video">www.ti.com/video</a>

### TI E2E Community

[e2e.ti.com](http://e2e.ti.com)