

## CPDU5V0U-HF

### RoHS Device

### Halogen Free



### Features

- Uni-directional ESD protection.
- IEC 61000-4-2 (ESD) ;  $\pm 30$ KV(contact)
- Working voltage:5V
- Surface mount package.
- High component density.

### Mechanical data

- Case: 0603/SOD-523F standard package , molded plastic.
- Terminals: Gold plated, solderable per MIL-STD-750, method 2026.
- Mounting position: Any.
- Weight: 0.003 grams(approx.).

### Circuit Diagram

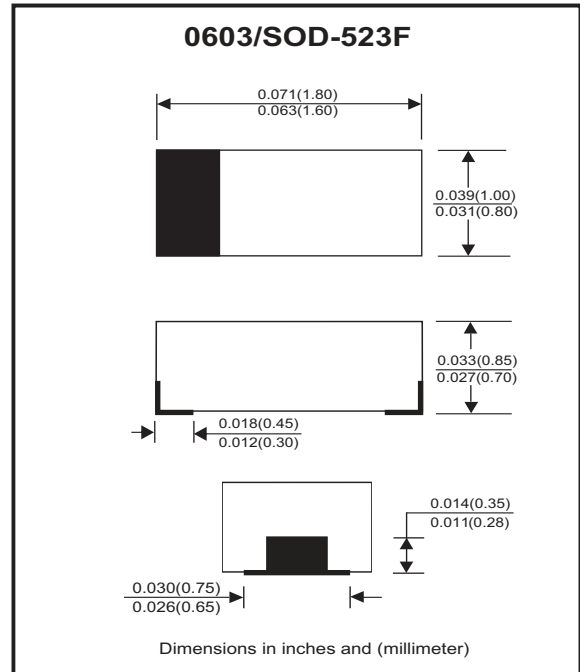

### Maximum Rating (at $T_A=25^\circ\text{C}$ unless otherwise noted)

Parameter	Conditions	Symbol	Value	Unit
Peak pulse power	$T_P = 8/20\mu\text{s}$	$P_{PP}$	180	W
Peak pulse current	$T_P = 8/20\mu\text{s}$	$I_{PP}$	15	A
ESD capability	IEC 61000-4-2(air)	ESD	$\pm 30$	kV
	IEC 61000-4-2(contact)	ESD	$\pm 30$	
Operation temperature range		$T_j$	$-40 \sim +125$	$^\circ\text{C}$
Storage temperature range		$T_{STG}$	$-55 \sim +150$	$^\circ\text{C}$

### Electrical Characteristics (at $T_A=25^\circ\text{C}$ unless otherwise noted)

Parameter	Conditions	Symbol	Min	Typ	Max	Unit
Working peak reverse voltage		$V_{RWM}$			5.0	V
Forward voltage	$I_F = 10\text{mA}$	$V_F$		0.8	1.2	V
Breakdown voltage	$I_T = 1\text{mA}$	$V_{BR}$	6			V
Reverse leakage current	$V_{RWM} = 5\text{V}$	$I_R$		0.2	2.0	$\mu\text{A}$
Clamping voltage	$I_{PP} = 1\text{A}, T_P = 8/20\mu\text{s}$	$V_C$		8	7.6	V
	$I_{PP} = 5\text{A}, T_P = 8/20\mu\text{s}$			10	9.4	
	$I_{PP} = 15\text{A}, T_P = 8/20\mu\text{s}$				12	
Junction capacitance	$V_R = 0\text{V}, f = 1\text{MHz}$	$C_J$		130		pF

Company reserves the right to improve product design , functions and reliability without notice.

REV:E

## RATING AND CHARACTERISTIC CURVES (CPDU5V0U-HF)

Fig.1- 8/20us Peak Pulse Current Wave Form Acc. IEC 61000-4-5

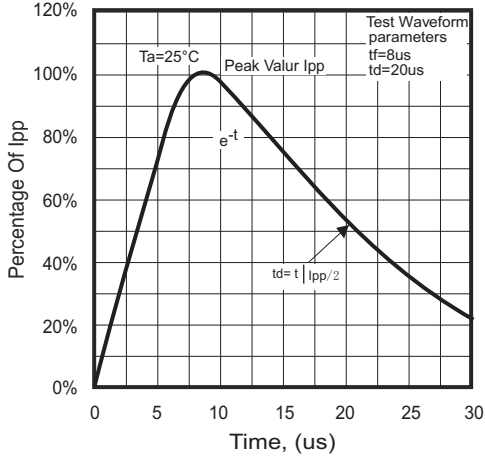

Fig.2 - Power Rating Derating Curve

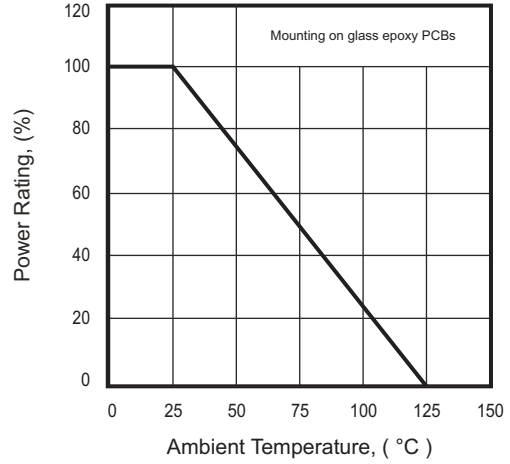

Fig.3 - Clamping Voltage Vs. Peak Pulse Current

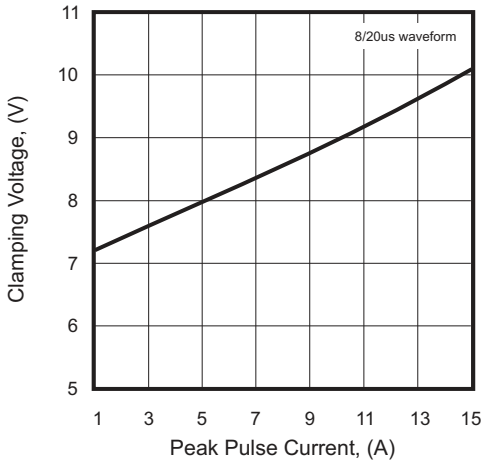

Fig.4 - Forward Characteristic

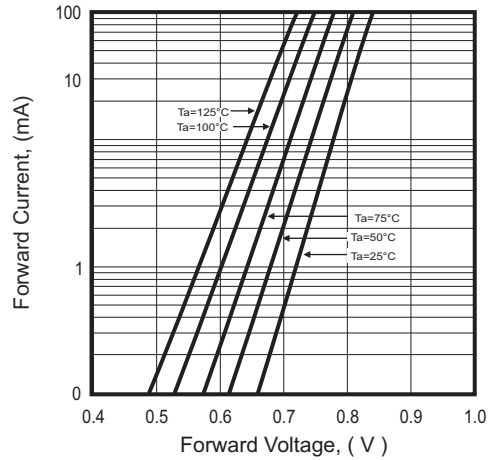
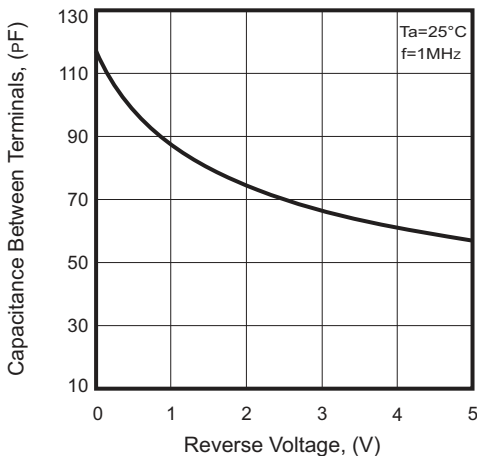
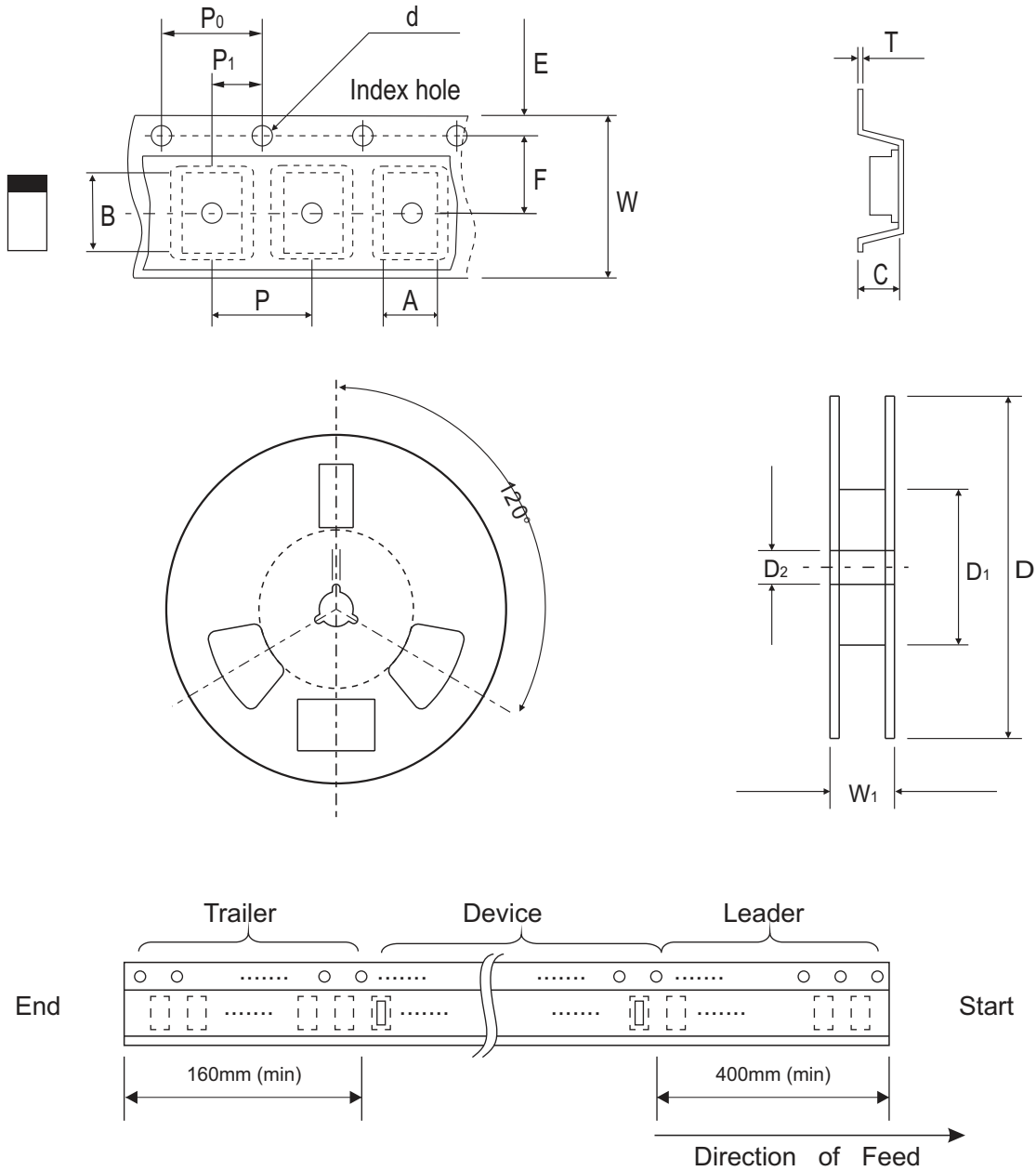

Fig.5 - Capacitance Between Terminals Characteristics



## Reel Taping Specification



0603 (SOD-523F)	SYMBOL	A	B	C	d	D	D <sub>1</sub>	D <sub>2</sub>
	(mm)	1.16 ± 0.10	1.90 ± 0.10	0.95 ± 0.10	1.50 + 0.10 - 0	178.00 ± 1.00	60.00 ± 0.50	13.50 ± 0.20
	(inch)	0.046 ± 0.004	0.075 ± 0.004	0.037 ± 0.004	0.059 + 0.004 - 0	7.008 ± 0.039	2.362 ± 0.020	0.531 ± 0.008

0603 (SOD-523F)	SYMBOL	E	F	P	P <sub>0</sub>	P <sub>1</sub>	T	W	W <sub>1</sub>
	(mm)	1.75 ± 0.10	3.50 ± 0.05	4.00 ± 0.10	4.00 ± 0.10	2.00 ± 0.05	0.22 + 0.10 - 0.05	8.00 ± 0.20	12.00 + 0.50 - 0
	(inch)	0.069 ± 0.004	0.138 ± 0.002	0.157 ± 0.004	0.157 ± 0.004	0.079 ± 0.002	0.009 + 0.004 - 0.002	0.315 ± 0.008	0.472 + 0.020 - 0

Company reserves the right to improve product design, functions and reliability without notice.

## Marking Code

Part Number	Marking Code
CPDU5V0U-HF	E05



## Suggested PAD Layout

SIZE	0603/SOD-523F	
	(mm)	(inch)
A	1.70	0.067
B	0.60	0.024
C	0.80	0.031
D	2.30	0.091
E	1.10	0.043

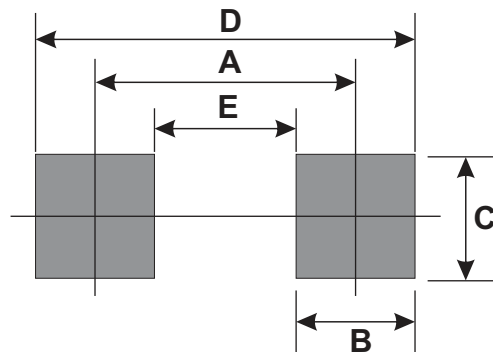

## Standard Packaging

Case Type	Qty Per Reel	Reel Size
	(Pcs)	(inch)
0603/SOD-523F	4,000	7