

 ABRACON CORPORATION <small>he Power of Linking Together</small>	AB18X5 Real-Time Clock with Power Management Family	 RoHS Compliant
Date of Issue: October 16, 2014	3.0 x 3.0 mm	 ESD Sensitive
<i>Page 1 of 37</i>	Abraccon Drawing #453568	Revision: C

Features

- Ultra-low supply current (all at 3V):
 - 14 nA with RC oscillator
 - 22 nA with RC oscillator and Autocalibration
 - 55 nA with crystal oscillator
- Baseline timekeeping features:
 - 32.768 kHz crystal oscillator with integrated load capacitor/resistor
 - Counters for hundredths, seconds, minutes, hours, date, month, year, century, and week-day
 - Alarm capability on all counters
 - Programmable output clock generation (32.768 kHz to 1 year)
 - Countdown timer with repeat function
 - Automatic leap year calculation
- Advanced timekeeping features:
 - Integrated power optimized RC oscillator
 - Advanced crystal calibration to ± 2 ppm
 - Advanced RC calibration to ± 16 ppm
 - Automatic calibration of RC oscillator to crystal oscillator
 - Watchdog timer with hardware reset
 - 256 bytes of general purpose RAM
- Power management features:
 - Integrated $\sim 1\Omega$ power switch for off-chip components such as a host MCU
 - System sleep manager for managing host processor wake/sleep states
 - External reset signal monitor
 - Reset output generator
 - Supercapacitor trickle charger with programmable charging current
 - Automatic switchover to VBAT
 - External interrupt monitor
 - Programmable low battery detection threshold
 - Programmable analog voltage comparator
- I²C (up to 400 kHz) and 3-wire or 4-wire SPI (up to 2 MHz) serial interfaces available
- Operating voltage 1.5-3.6 V
- Clock and RAM retention voltage 1.5-3.6 V
- Operating temperature -40 to 85 °C
- All inputs include Schmitt Triggers
- 3x3 mm QFN-16 package



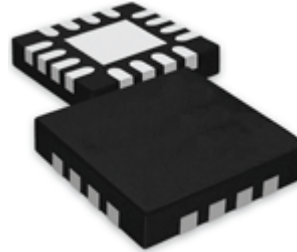

Applications

- Smart cards
- Wireless sensors and tags
- Medical electronics
- Utility meters
- Data loggers
- Appliances
- Handsets
- Consumer electronics
- Communications equipment

Description

The ABRACON AB18X5 Real-Time Clock with Power Management family provides a groundbreaking combination of ultra-low power coupled with a highly sophisticated feature set. With power requirements significantly lower than any other industry RTC (as low as 14 nA), these are the first semiconductors based on innovative SPOT™ (Subthreshold Power Optimized Technology) CMOS platform. The AB18X5 includes on-chip oscillators to provide minimum power consumption, full RTC functions including battery backup and programmable counters and alarms for timer and watchdog functions, and either an I²C or SPI serial interface for communication with a host controller. An integrated power switch and a sophisticated system sleep manager with counter, timer, alarm, and interrupt capabilities allows the AB18X5 to be used as a supervisory component in a host microcontroller based system.

Disclaimer: AB18X5 series of devices are based on innovative SPOT technology, proprietary to Ambiq Micro.



 ABRACON CORPORATION <i>the Power of Linking Together</i>	AB18X5 Real-Time Clock with Power Management Family	 RoHS Compliant
Date of Issue: October 16, 2014	3.0 x 3.0 mm	 ESD Sensitive
<i>Page 2 of 37</i>	Abracon Drawing #453568	Revision: C

1. Family Summary

The AB18X5 family consists of several members (see Table 1). All devices are supplied in a standard 3x3 mm QFN-16 package. Members of the software and pin compatible AB08X5 RTC family are also listed.

Table 1: Family Summary

Part #	Baseline Timekeeping		Advanced Timekeeping				Power Management				Interface
	XT Osc	Number of GP Outputs	RC Osc	Calib/ Auto-calib	Watch-dog	RAM (B)	VBAT Switch	Reset Mgmt	Ext Int	Power Switch and Sleep FSM	
AB1805	■	4	■	■	■	256	■	■	■	■	I ² C
AB1815	■	3	■	■	■	256	■	■	■	■	SPI
Software and Pin Compatible AB08X5 Family Components											
AB0805	■	3	■	■	■	256	■		■		I ² C
AB0815	■	2	■	■	■	256	■		■		SPI

 ABRACON CORPORATION <i>the Power of Linking Together</i>	AB18X5 Real-Time Clock with Power Management Family	 RoHS Compliant
Date of Issue: October 16, 2014	3.0 x 3.0 mm	 ESD Sensitive
<i>Page 3 of 37</i>	Abracorn Drawing #453568	Revision: C

2. Functional Description

Figure 1 illustrates the AB18X5 functional design.

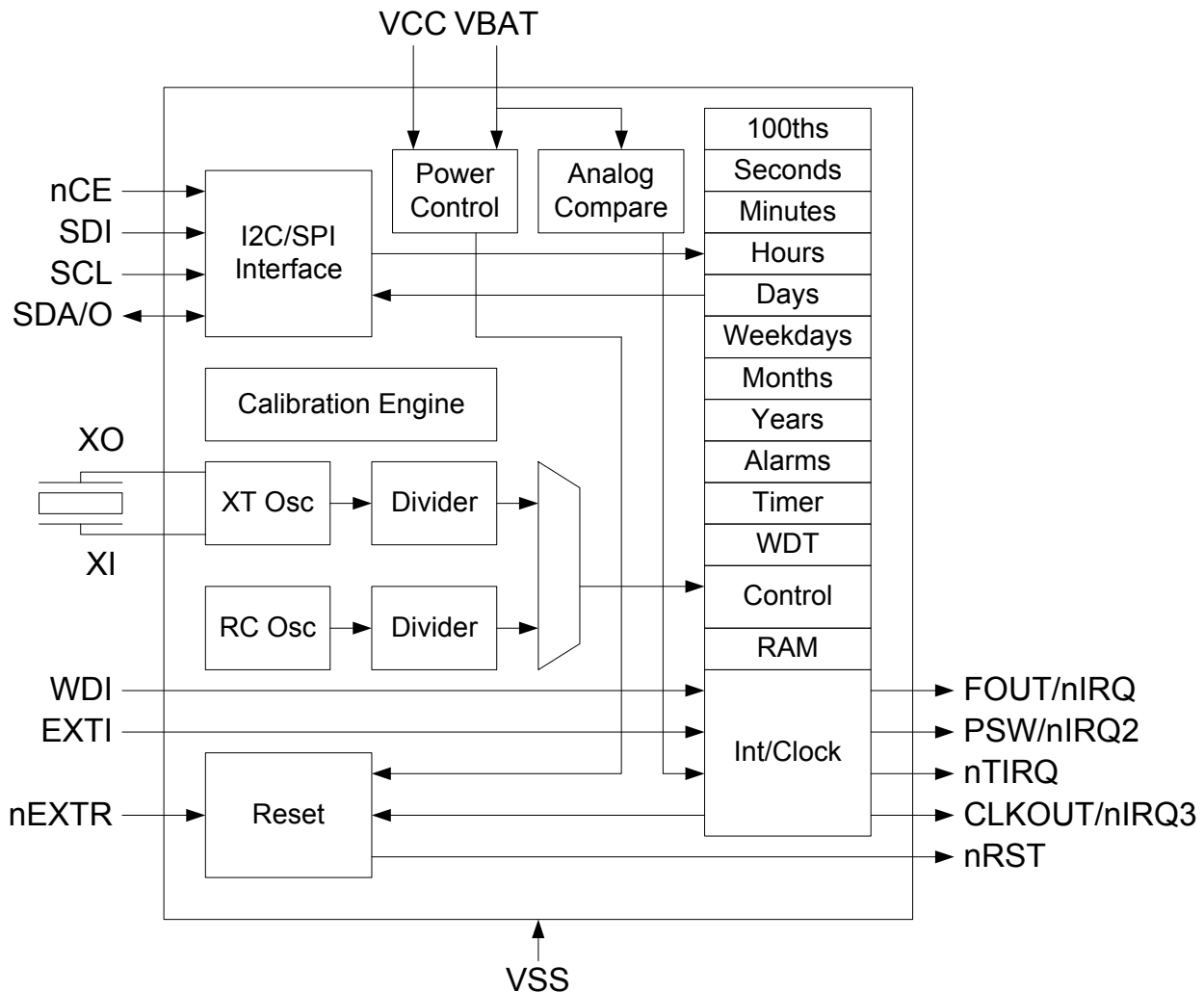





Figure 1. Detailed Block Diagram

AB18X5 serves as a companion part for host processors including microcontrollers, radios, and digital signal processors. It tracks time as in a typical RTC product and additionally provides unique power management functionality that makes it ideal for highly energy-constrained applications. To support such operation, the AB18X5 includes 3 distinct feature groups: 1) baseline timekeeping features, 2) advanced timekeeping features, and 3) power management features. Functions from each feature group may be controlled via I/O offset mapped registers. These registers are accessed using either an I²C serial interface (e.g., in the AB1805) or a SPI serial interface (e.g., in the AB1815). Each feature group is described briefly below and in greater detail in subsequent sections.

The baseline timekeeping feature group supports the standard 32.786 kHz crystal (XT) oscillation mode for maximum frequency accuracy with an ultra-low current draw of 55 nA. The baseline timekeeping feature group also includes a standard set of counters monitoring hundredths of a second up through centuries. A



	AB18X5 Real-Time Clock with Power Management Family	
Date of Issue: October 16, 2014	3.0 x 3.0 mm	
<i>Page 4 of 37</i>	Abracon Drawing #453568	Revision: C

complement of countdown timers and alarms may additionally be set to initiate interrupts or resets on several of the outputs.

The advanced timekeeping feature group supports two additional oscillation modes: 1) RC oscillator mode, and 2) Autocalibration mode. At only 14 nA, the temperature-compensated RC oscillator mode provides an even lower current draw than the XT oscillator for applications with reduced frequency accuracy requirements. A proprietary calibration algorithm allows the AB18X5 to digitally tune the RC oscillator frequency and the XT oscillator frequency with accuracy as low as 2 ppm at a given temperature. In Autocalibration mode, the RC oscillator is used as the primary oscillation source and is periodically calibrated against the XT oscillator. Autocalibration may be done automatically every 8.5 minutes or 17 minutes and may also be initiated via software. This mode enables average current draw of only 22 nA with frequency accuracy similar to the XT oscillator. The advanced timekeeping feature group also includes a rich set of input and output configuration options that enables the monitoring of external interrupts (e.g., pushbutton signals), the generation of clock outputs, and watchdog timer functionality.

Power management features built into the AB18X5 enable it to operate as a backup device in both line-powered and battery-powered systems. An integrated power control module automatically detects when main power (VCC) falls below a threshold and switches to backup power (VBAT). 256B of ultra-low leakage RAM enable the storage of key parameters when operating on backup power.

The AB18X5 is the first RTC to incorporate a number of more advanced power management features. In particular, the AB18X5 includes a finite state machine (integrated with the Power Control block in Figure 1) that can control a host processor as it transitions between sleep/reset states and active states. Digital outputs can be configured to control the reset signal or interrupt input of the host controller. The AB18X5 additionally integrates a power switch with $\sim 1 \Omega$ impedance that can be used to cut off ground current on the host microcontroller and reduce sleep current to < 1 nA. The AB18X5 parts can wake up a sleeping system using internally generated timing interrupts or externally generated interrupts generated by digital inputs (e.g., using a pushbutton) or an analog comparator. The aforementioned functionality enables users to seamlessly power down host processors, leaving only the energy-efficient AB18X5 chip awake. The AB18X5 also includes voltage detection on the backup power supply.

 ABRACON CORPORATION <i>the Power of Linking Together</i>	AB18X5 Real-Time Clock with Power Management Family	 RoHS Compliant
Date of Issue: October 16, 2014	3.0 x 3.0 mm	 ESD Sensitive
<i>Page 5 of 37</i>	Abracon Drawing #453568	Revision: C

3. AB18X5 Application Examples

The AB18X5 enables a variety of system implementations in which the AB18X5 can control power usage by other elements in the system. This is typically used when the entire system is powered from a battery and minimizing total power usage is critical. The backup RAM in the AB18X5 can be used to hold key MCU parameters when it is powered down.

3.1 VSS Power Switched

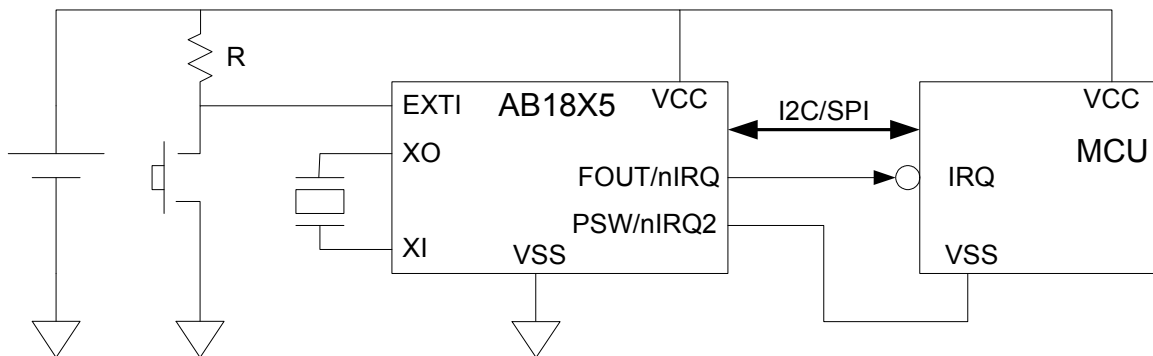

In the recommended implementation, the internal power switch of the AB18X5 is used to completely turn off the MCU and/or other system elements. In this case the PSW/nIRQ2 output is configured to generate the Sleep function. Under normal circumstances, the PSW/nIRQ2 pin is pulled to VSS with less than 1 ohm of resistance, so that the MCU receives full power. The MCU initiates a SLP operation, and when the AB18X5 enters Sleep Mode the PSW/nIRQ2 pin is opened and power is completely removed from the MCU. This results in significant additional power savings relative to the other alternatives. A variety of interrupts, including alarms, timers and external interrupts created by a pushbutton as shown, may be used to exit Sleep Mode and restore MCU power. The RAM of the AB18X5 may be used to retain critical MCU parameters.

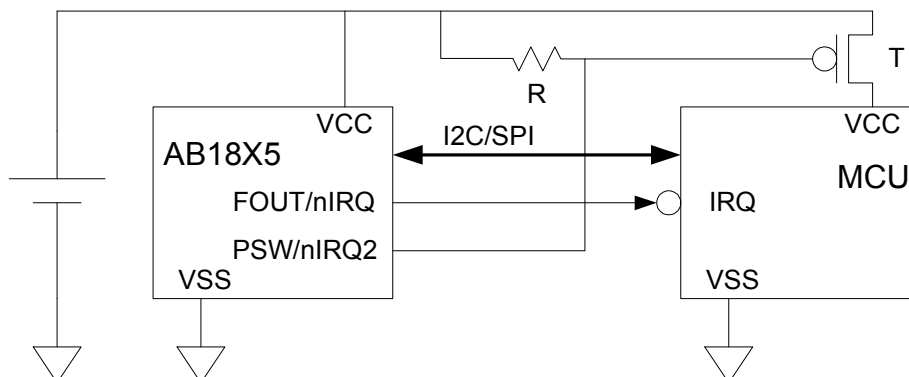

3.2 VCC Power Switched

An external transistor switch T may also be used to turn off power to the MCU. This implementation allows switching higher current and maintains a common ground. R can be on the order of megohms, so that negligible current is drawn when the circuit is active and PSW/nIRQ2 is low.



 ABRACON CORPORATION <i>the Power of Linking Together</i>	AB18X5 Real-Time Clock with Power Management Family	 RoHS Compliant
Date of Issue: October 16, 2014	3.0 x 3.0 mm	 ESD Sensitive
<i>Page 6 of 37</i>	Abracorn Drawing #453568	Revision: C

3.3 Reset Driven

In another implementation the AB18X5 controls the system MCU using the reset function rather than switching power. Since many MCUs use much less power when reset, this implementation can save system power in some cases.

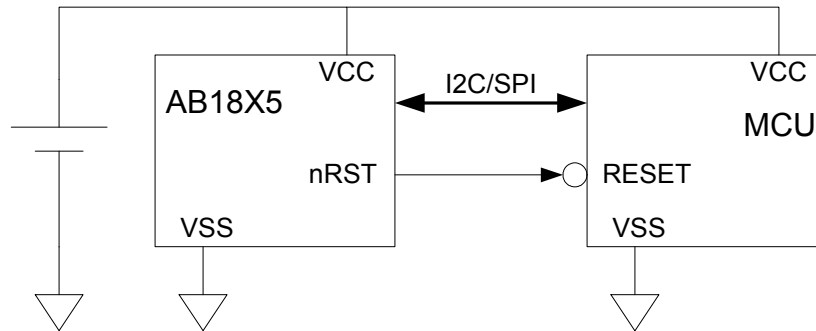

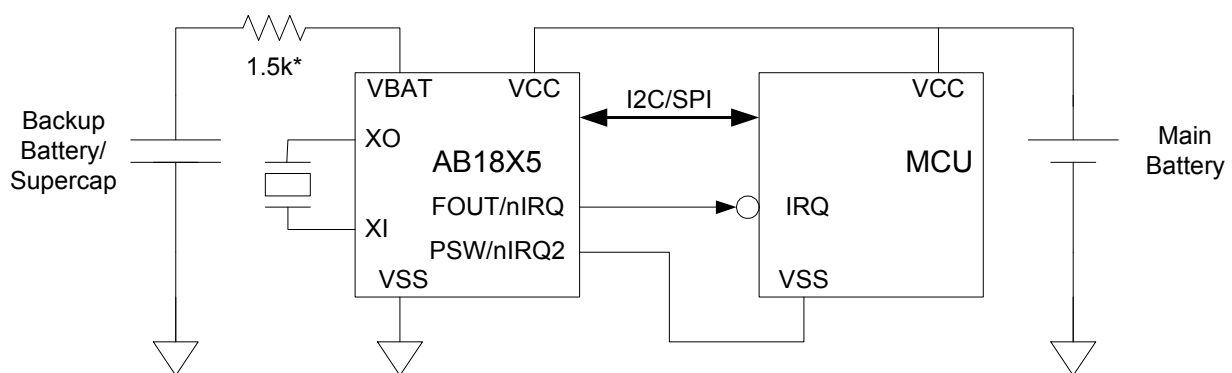

3.4 Battery Backup

In many systems the main power supply is a battery, so the AB18X5 can minimize its current draw by powering down the MCU and other peripherals. This battery may be replaceable, and a supercapacitor charged via the AB18X5 trickle charger can maintain system time and key parameters when the main battery is removed.



* Total battery series impedance = 1.5k ohms, which may require an external resistor

 ABRACON CORPORATION <i>he Power of Linking Together</i>	AB18X5 Real-Time Clock with Power Management Family	 RoHS Compliant
Date of Issue: October 16, 2014	3.0 x 3.0 mm	 ESD Sensitive
<i>Page 7 of 37</i>	Abracon Drawing #453568	Revision: C

4. Package Pins

4.1 Pin Configuration and Connections

Figure 2 and Table 2 show the QFN-16 pin configurations for the AB18X5 parts. Pins labeled NC must be left unconnected. The thermal pad, pin 17, on the QFN-16 packages must be connected to VSS.

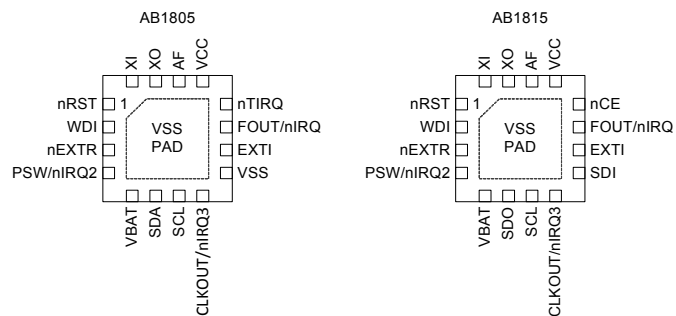





Figure 2. Pin Configuration Diagram

Table 2: Pin Connections

Pin Name	Pin Type	Function	Pin Number	
			AB1805	AB1815
VSS	Power	Ground	9,17	17
VCC	Power	System power supply	13	13
XI	XT	Crystal input	16	16
XO	XT	Crystal output	15	15
AF	Output	Autocalibration filter	14	14
VBAT	Power	Battery power supply	5	5
SCL	Input	I ² C or SPI interface clock	7	7
SDO	Output	SPI data output		6
SDI	Input	SPI data input		9
nCE	Input	SPI chip select		12
SDA	Input	I ² C data input/output	6	
EXTI	Input	External interrupt input	10	10
WDI	Input	Watchdog reset input	2	2
nEXTR	Input	External reset input	3	3
FOUT/nIRQ	Output	Int 1/function output	11	11
nIRQ2	Output	Int 2 output	4	4
CLKOUT/nIRQ3	Output	Int 3/clock output	8	8
nTIRQ	Output	Timer interrupt output	12	
nRST	Output	Reset output	1	1

 ABRACON CORPORATION <i>he Power of Linking Together</i>	AB18X5 Real-Time Clock with Power Management Family	 RoHS Compliant
Date of Issue: October 16, 2014	3.0 x 3.0 mm	 ESD Sensitive
<i>Page 8 of 37</i>	Abrakon Drawing #453568	Revision: C

4.2 Pin Descriptions

Table 3 provides a description of the pin connections.

Table 3: Pin Descriptions

Pin Name	Description
VSS	Ground connection. In the QFN-16 packages the ground slug on the bottom of the package must be connected to VSS.
VCC	Primary power connection. If a single power supply is used, it must be connected to VCC.
VBAT	Battery backup power connection. If a backup battery is not present, VBAT must be connected directly to VSS, but it may also be used to provide the analog input to the internal comparator (see Analog-Comparator).
XI	Crystal oscillator input connection.
XO	Crystal oscillator output connection.
AF	Autocalibration filter connection. A 47pF ceramic capacitor must be placed between this pin and VSS for improved Autocalibration mode timing accuracy.
SCL	I/O interface clock connection. It provides the SCL input in both I ² C and SPI interface parts. A pull-up resistor is required on this pin.
SDA (only available in I ² C environments)	I/O interface I ² C data connection. A pull-up resistor is required on this pin.
SDO (only available in SPI environments)	I/O interface SPI data output connection.
SDI	I/O interface SPI data input connection.
nCE (only available in SPI environments)	I/O interface SPI chip select input connection. It is an active low signal. A pull-up resistor is recommended to be connected to this pin to ensure it is not floating. A pull-up resistor also prevents inadvertent writes to the RTC during power transitions.
EXTI	External interrupt input connection. It may be used to generate an External 1 interrupt with polarity selected by the EX1P bit if enabled by the EX1E bit. The value of the EXTI pin may be read in the EXIN register bit. This pin does not have an internal pull-up or pull-down resistor and so one must be added externally. It must not be left floating or the RTC may consume higher current. Instead, it must be connected directly to either VCC or VSS if not used.
WDI	Watchdog Timer reset input connection. It may also be used to generate an External 2 interrupt with polarity selected by the EX2P bit if enabled by the EX2E bit. The value of the WDI pin may be read in the WDIN register bit. This pin does not have an internal pull-up or pull-down resistor and so one must be added externally. It must not be left floating or the RTC may consume higher current. Instead, it must be connected directly to either VCC or VSS if not used.
nEXTR	External reset input connection. If nEXTR is low and the RS1E bit is set, the nRST output will be driven to its asserted value as determined by the RSP bit. This pin does not have an internal pull-up or pull-down resistor and so one must be added externally. It must not be left floating or the RTC may consume higher current. Instead, it must be connected directly to either VCC or VSS if not used.
FOUT/nIRQ	Primary interrupt output connection. This pin is an open drain output. An external pull-up resistor must be added to this pin. It should be connected to the host device and is used to indicate when the RTC can be accessed via the serial interface. FOUT/nIRQ may be configured to generate several signals as a function of the OUT1S field(see 0x11 - Control2). FOUT/nIRQ is also asserted low on a power up until the AB18X5 has exited the reset state and is accessible via the I/O interface. <ul style="list-style-type: none"> 1. FOUT/nIRQ can drive the value of the OUT bit. 2. FOUT/nIRQ can drive the inverse of the combined interrupt signal IRQ (see Interrupts). 3. FOUT/nIRQ can drive the square wave output (see 0x13 - SQW) if enabled by SQWE. 4. FOUT/nIRQ can drive the inverse of the alarm interrupt signal AIRQ (see Interrupts).







 ABRACON CORPORATION <i>the Power of Linking Together</i>	AB18X5 Real-Time Clock with Power Management Family	 RoHS Compliant
Date of Issue: October 16, 2014	3.0 x 3.0 mm	 ESD Sensitive
<i>Page 9 of 37</i>	Abracon Drawing #453568	Revision: C

Table 3: Pin Descriptions

Pin Name	Description
PSW/nIRQ2	<p>Secondary interrupt output connection. It is an open drain output. This pin can be left floating if not used. PSW/nIRQ2 may be configured to generate several signals as a function of the OUT2S field (see 0x11 - Control2). This pin will be configured as an ~1 Ω switch if the PWR2 bit is set.</p> <ol style="list-style-type: none"> 1. PSW/nIRQ2 can drive the value of the OUTB bit. 2. PSW/nIRQ2 can drive the square wave output (see 0x13 - SQW) if enabled by SQWE. 3. PSW/nIRQ2 can drive the inverse of the combined interrupt signal IRQ(see Interrupts). 4. PSW/nIRQ2 can drive the inverse of the alarm interrupt signal AIRQ(see Interrupts). 5. PSW/nIRQ2 can drive either sense of the timer interrupt signal TIRQ. 6. PSW/nIRQ2 can function as the power switch output for controlling the power of external devices (see Sleep Control).
nTIRQ (only available in I ² C environments)	<p>Timer interrupt output connection. It is an open drain output. nTIRQ always drives the active low nTIRQ signal. If this pin is used, an external pull-up resistor must be added to this pin. If the pin is not used, it can be left floating.</p>
CLKOUT/nIRQ3	<p>Square Wave output connection. It is a push-pull output, and may be configured to generate one of two signals.</p> <ol style="list-style-type: none"> 1. CLKOUT/nIRQ3 can drive the value of the OUT bit. 2. CLKOUT/nIRQ3 can drive the square wave output (see 0x13 - SQW) if enabled by SQWE.
nRST	<p>External reset output connection. It is an open drain output. If this pin is used, an external pull-up resistor must be added to this pin. If the pin is not used, it can be left floating. The polarity is selected by the RSP bit, which will initialize to 0 on power up to produce an active low output. See Autocalibration Fail Interrupt ACIRQ for details of the generation of nRST.</p>

 ABRACON CORPORATION <i>the Power of Linking Together</i>	AB18X5 Real-Time Clock with Power Management Family	 RoHS Compliant
Date of Issue: October 16, 2014	3.0 x 3.0 mm	 ESD Sensitive
<i>Page 10 of 37</i>	Abracon Drawing #453568	Revision: C



5. Electrical Specifications

5.1 Absolute Maximum Ratings

Table 4 lists the absolute maximum ratings.

Table 4: Absolute Maximum Ratings

SYMBOL	PARAMETER	TEST CONDITIONS	MIN	TYP	MAX	UNIT
V _{CC}	System Power Voltage		-0.3		3.8	V
V _{BAT}	Battery Voltage		-0.3		3.8	V
V _I	Input voltage	VCC Power state	-0.3		V _{CC} + 0.3	V
V _I	Input voltage	VBAT Power state	-0.3		V _{BAT} + 0.3	V
V _O	Output voltage	VCC Power state	-0.3		V _{CC} + 0.3	V
V _O	Output voltage	VBAT Power state	-0.3		V _{BAT} + 0.3	V
I _I	Input current		-10		10	mA
I _O	Output current		-20		20	mA
I _{OPC}	PSW Output continuous current				50	mA
I _{OPP}	PSW Output pulsed current	1 second pulse			150	mA
V _{ESD}	ESD Voltage	CDM			±500	V
		HBM			±4000	V
I _{LU}	Latch-up Current				100	mA
T _{STG}	Storage Temperature		-55		125	°C
T _{OP}	Operating Temperature		-40		85	°C
T _{SLD}	Lead temperature	Hand soldering for 10 seconds			300	°C
T _{REF}	Reflow soldering temperature	Reflow profile per JEDEC J-STD-020D.1			260	°C

 ABRACON CORPORATION <i>he Power of Linking Together</i>	AB18X5 Real-Time Clock with Power Management Family	 RoHS Compliant
Date of Issue: October 16, 2014	3.0 x 3.0 mm	 ESD Sensitive
<i>Page 11 of 37</i>	Abracon Drawing #453568	Revision: C

5.2 Power Supply Parameters

Figure 3 and Table 5 describe the power supply and switchover parameters. See Power Control and Switching for a detailed description of the operations.

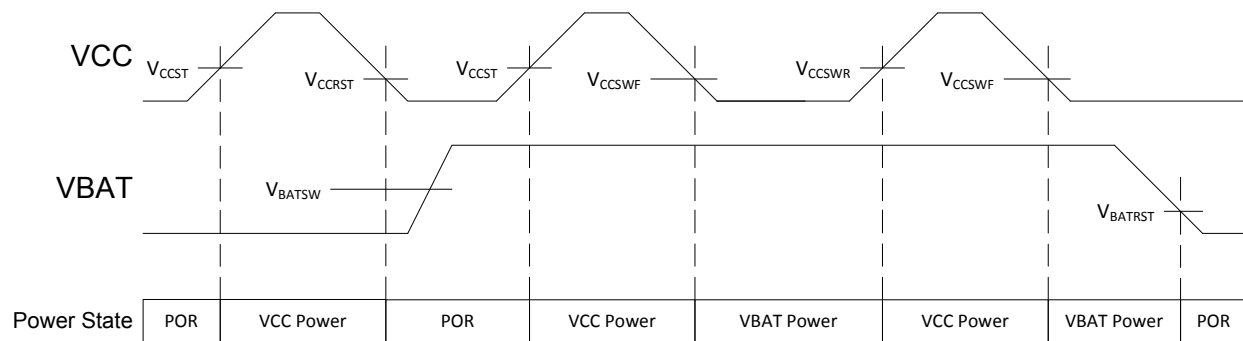

Figure 3. Power Supply Switchover



For Table 5, $T_A = -40\text{ }^{\circ}\text{C}$ to $85\text{ }^{\circ}\text{C}$, TYP values at $25\text{ }^{\circ}\text{C}$.

Table 5: Power Supply and Switchover Parameters

SYMBOL	PARAMETER	PWR	TYPE	POWER STATE	TEST CONDITIONS	MIN	TYP	MAX	UNIT
V_{CC}	System Power Voltage	VCC	Static	VCC Power	Clocks operating and RAM and registers retained	1.5		3.6	V
V_{CCIO}	VCC I/O Interface Voltage	VCC	Static	VCC Power	I ² C or SPI operation	1.5		3.6	V
V_{CCST}	VCC Start-up Voltage ⁽¹⁾	VCC	Rising	POR -> VCC Power		1.6			V
V_{CCRST}	VCC Reset Voltage	VCC	Falling	VCC Power -> POR	$V_{BAT} < V_{BAT,MIN}$ or no V_{BAT}		1.3	1.5	V
V_{CCSWR}	VCC Rising Switchover Threshold Voltage	VCC	Rising	VBAT Power -> VCC Power	$V_{BAT} \geq V_{BATRST}$		1.6	1.7	V
V_{CCSWF}	VCC Falling Switchover Threshold Voltage	VCC	Falling	VCC Power -> VBAT Power	$V_{BAT} \geq V_{BATSW,MIN}$	1.2	1.5		V
V_{CCSWH}	VCC Switchover Threshold Hysteresis ⁽²⁾	VCC	Hyst.	VCC Power <-> VBAT Power			70		mV
V_{CCFS}	VCC Falling Slew Rate to switch to VBAT state ⁽⁴⁾	VCC	Falling	VCC Power -> VBAT Power	$V_{CC} < V_{CCSW,MAX}$	0.7	1.4		V/ms
V_{BAT}	Battery Voltage	VBAT	Static	VBAT Power	Clocks operating and RAM and registers retained	1.4		3.6	V
V_{BATSW}	Battery Switchover Voltage Range ⁽⁵⁾	VBAT	Static	VCC Power -> VBAT Power		1.6		3.6	V







 ABRACON CORPORATION <i>the Power of Linking Together</i>	AB18X5 Real-Time Clock with Power Management Family	 RoHS Compliant
Date of Issue: October 16, 2014	3.0 x 3.0 mm	 ESD Sensitive
<i>Page 12 of 37</i>	Abracon Drawing #453568	Revision: C

Table 5: Power Supply and Switchover Parameters

SYMBOL	PARAMETER	PWR	TYPE	POWER STATE	TEST CONDITIONS	MIN	TYP	MAX	UNIT
V _{BATRST}	Falling Battery POR Voltage ⁽⁷⁾	VBAT	Falling	VBAT Power → POR	V _{CC} < V _{CCSWF}		1.1	1.4	V
V _{BMRG}	V _{BAT} Margin above V _{CC} ⁽³⁾	VBAT	Static	V _{BAT} Power		200			mV
V _{BATESR}	V _{BAT} supply series resistance ⁽⁶⁾	VBAT	Static	V _{BAT} Power		1.0	1.5		kΩ

⁽¹⁾ V_{CC} must be above V_{CCST} to exit the POR state, independent of the V_{BAT} voltage.
⁽²⁾ Difference between V_{CCSWR} and V_{CCSWF}.
⁽³⁾ V_{BAT} must be higher than V_{CC} by at least this voltage to ensure the AB18X5 remains in the VBAT Power state.
⁽⁴⁾ Maximum VCC falling slew rate to guarantee correct switchover to VBAT Power state. There is no V_{CC} falling slew rate requirement if switching to the VBAT power source is not required.
⁽⁵⁾ V_{BAT} voltage to guarantee correct transition to VBAT Power state when V_{CC} falls.
⁽⁶⁾ Total series resistance of the power source attached to the VBAT pin. The optimal value is 1.5kΩ, which may require an external resistor. VBAT power source ESR + external resistor value = 1.5kΩ.
⁽⁷⁾ V_{BATRST} is also the static voltage required on V_{BAT} for register data retention.

 ABRACON CORPORATION <i>he Power of Linking Together</i>	AB18X5 Real-Time Clock with Power Management Family	 RoHS Compliant
Date of Issue: October 16, 2014	3.0 x 3.0 mm	 ESD Sensitive
<i>Page 13 of 37</i>	Abracon Drawing #453568	Revision: C

5.3 Operating Parameters



Table 6 lists the operating parameters.



For Table 6, $T_A = -40\text{ }^{\circ}\text{C}$ to $85\text{ }^{\circ}\text{C}$, TYP values at $25\text{ }^{\circ}\text{C}$.

Table 6: Operating Parameters

SYMBOL	PARAMETER	TEST CONDITIONS	V_{CC}	MIN	TYP	MAX	UNIT
V_{T+}	Positive-going Input Threshold Voltage		3.0V		1.5	2.0	V
			1.8V		1.1	1.25	
V_{T-}	Negative-going Input Threshold Voltage		3.0V	0.8	0.9		V
			1.8V	0.5	0.6		
I_{LEAK}	Input leakage current		3.0V		0.02	80	nA
C_I	Input capacitance				3		pF
V_{OH}	High level output voltage on push-pull outputs		1.7V – 3.6V	$0.8 \cdot V_{CC}$			V
V_{OL}	Low level output voltage		1.7V – 3.6V			$0.2 \cdot V_{CC}$	V
I_{OH}	High level output current on push-pull outputs	$V_{OH} = 0.8 \cdot V_{CC}$	1.7V	-2	-3.8		mA
			1.8V	-3	-4.3		
			3.0V	-7	-11		
			3.6V	-8.8	-15		
I_{OL}	Low level output current	$V_{OL} = 0.2 \cdot V_{CC}$	1.7V	3.3	5.9		mA
			1.8V	6.1	6.9		
			3.0V	17	19		
			3.6V	18	20		
R_{DSON}	PSW output resistance to VSS	PSW Enabled	1.7V		1.7	5.8	Ω
			1.8V		1.6	5.4	
			3.0V		1.1	3.8	
			3.6V		1.05	3.7	
I_{OLEAK}	Output leakage current		1.7V – 3.6V		0.02	80	nA

 ABRACON CORPORATION <i>he Power of Linking Together</i>	AB18X5 Real-Time Clock with Power Management Family	 RoHS Compliant
Date of Issue: October 16, 2014	3.0 x 3.0 mm	 ESD Sensitive
<i>Page 14 of 37</i>	Abracon Drawing #453568	Revision: C

5.4 Oscillator Parameters

Table 7 lists the oscillator parameters.



For Table 7, $T_A = -40\text{ }^\circ\text{C}$ to $85\text{ }^\circ\text{C}$ unless otherwise indicated.
 $V_{CC} = 1.7$ to 3.6V , TYP values at $25\text{ }^\circ\text{C}$ and 3.0V .

Table 7: Oscillator Parameters

SYMBOL	PARAMETER	TEST CONDITIONS	MIN	TYP	MAX	UNIT
F_{XT}	XI and XO pin Crystal Frequency			32.768		kHz
F_{OF}	XT Oscillator failure detection frequency			8		kHz
C_{INX}	Internal XI and XO pin capacitance			1		pF
C_{EX}	External XI and XO pin PCB capacitance			1		pF
OA_{XT}	XT Oscillation Allowance	At $25\text{ }^\circ\text{C}$ using a 32.768 kHz crystal	270	320		k Ω
F_{RCC}	Calibrated RC Oscillator Frequency ⁽¹⁾	Factory Calibrated at $25\text{ }^\circ\text{C}$, $V_{CC} = 2.8\text{V}$		128		Hz
F_{RCU}	Uncalibrated RC Oscillator Frequency	Calibration Disabled (OFF-SETR = 0)	89	122	220	Hz
J_{RCCC}	RC Oscillator cycle-to-cycle jitter	Calibration Disabled (OFF-SETR = 0) – 128 Hz		2000		ppm
		Calibration Disabled (OFF-SETR = 0) – 1 Hz		500		
A_{XT}	XT mode digital calibration accuracy ⁽¹⁾	Calibrated at an initial temperature and voltage	-2		2	ppm
A_{AC}	Autocalibration mode timing accuracy, 512 second period, $T_A = -10\text{ }^\circ\text{C}$ to $60\text{ }^\circ\text{C}$ ⁽¹⁾	24 hour run time		35		ppm
		1 week run time		20		
		1 month run time		10		
		1 year run time		3		
T_{AC}	Autocalibration mode operating temperature ⁽²⁾		-10		60	$^\circ\text{C}$

⁽¹⁾ Timing accuracy is specified at $25\text{ }^\circ\text{C}$ after digital calibration of the internal RC oscillator and 32.768 kHz crystal. A typical 32.768 kHz tuning fork crystal has a negative temperature coefficient with a parabolic frequency deviation, which due to the crystal alone can result in a change of up to 150 ppm across the entire operating temperature range of $-40\text{ }^\circ\text{C}$ to $85\text{ }^\circ\text{C}$ in XT mode. Autocalibration mode timing accuracy is specified relative to XT mode timing accuracy from $-10\text{ }^\circ\text{C}$ to $60\text{ }^\circ\text{C}$.

⁽²⁾ Outside of this temperature range, the RC oscillator frequency change due to temperature may be outside of the allowable RC digital calibration range ($\pm 12\%$) for autocalibration mode. If this happens, an autocalibration failure will occur and the ACF interrupt flag is set. The AB18X5 should be switched to use the XT oscillator as its clock source. Please see the Autocalibration Fail section for more details.



 ABRACON CORPORATION <i>the Power of Linking Together</i>	AB18X5 Real-Time Clock with Power Management Family	 RoHS Compliant
Date of Issue: October 16, 2014	3.0 x 3.0 mm	 ESD Sensitive
<i>Page 15 of 37</i>	Abracorn Drawing #453568	Revision: C

Figure 4 shows the typical calibrated RC oscillator frequency variation vs. temperature. RC oscillator calibrated at 2.8V, 25°C.

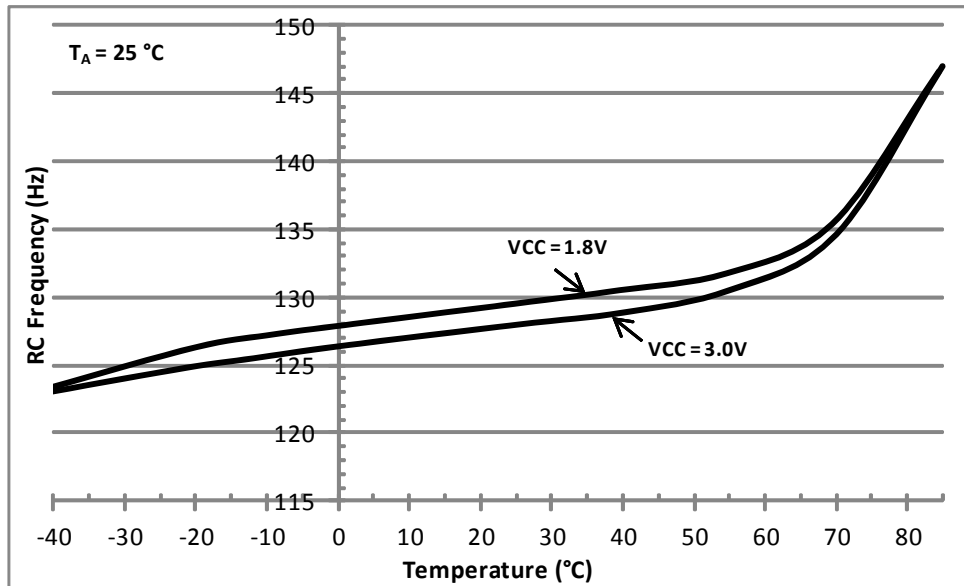

Figure 4. Calibrated RC Oscillator Typical Frequency Variation vs. Temperature

Figure 5 shows the typical uncalibrated RC oscillator frequency variation vs. temperature.

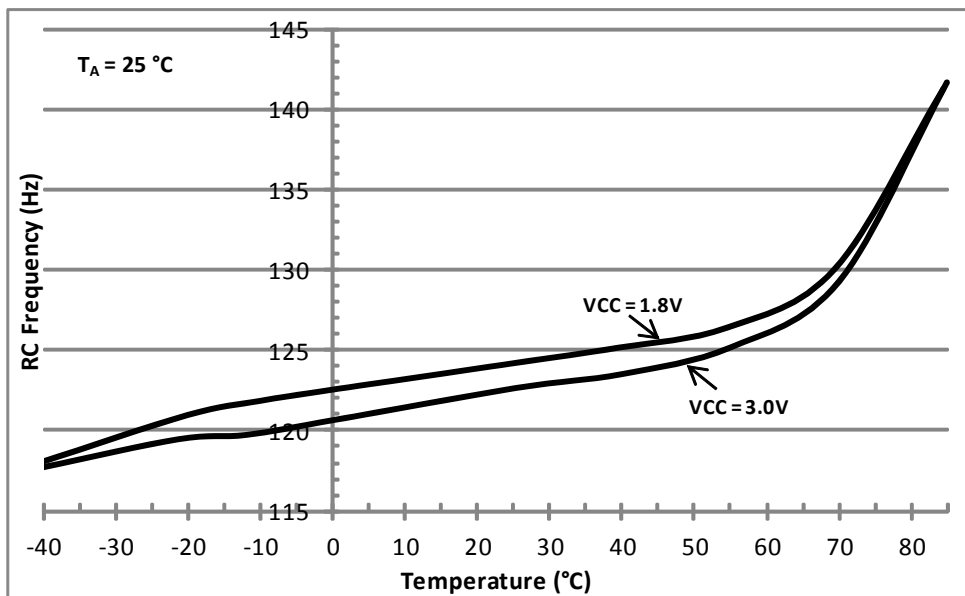





Figure 5. Uncalibrated RC Oscillator Typical Frequency Variation vs. Temperature

 ABRACON CORPORATION <i>the Power of Linking Together</i>	AB18X5 Real-Time Clock with Power Management Family	 RoHS Compliant
Date of Issue: October 16, 2014	3.0 x 3.0 mm	 ESD Sensitive
<i>Page 16 of 37</i>	Abracon Drawing #453568	Revision: C

5.5 V_{CC} Supply Current

Table 8 lists the current supplied into the VCC power input under various conditions.



For Table 8, T_A = -40 °C to 85 °C, V_{BAT} = 0 V to 3.6 V
TYP values at 25 °C, MAX values at 85 °C, VCC Power state

Table 8: V_{CC} Supply Current

SYMBOL	PARAMETER	TEST CONDITIONS	VCC	MIN	TYP	MAX	UNIT
I _{VCC:I2C}	V _{CC} supply current during I ² C burst read/write	400kHz bus speed, 2.2k pull-up resistors on SCL/SDA ⁽¹⁾	3.0V		6	10	μA
			1.8V		1.5	3	
I _{VCC:SPIW}	V _{CC} supply current during SPI burst write	2 MHz bus speed ⁽²⁾	3.0V		8	12	μA
			1.8V		4	6	
I _{VCC:SPIR}	V _{CC} supply current during SPI burst read	2 MHz bus speed ⁽²⁾	3.0V		23	37	μA
			1.8V		13	21	
I _{VCC:XT}	V _{CC} supply current in XT oscillator mode	Time keeping mode with XT oscillator running ⁽³⁾	3.0V		55	330	nA
			1.8V		51	290	
I _{VCC:RC}	V _{CC} supply current in RC oscillator mode	Time keeping mode with only the RC oscillator running (XT oscillator is off) ⁽³⁾	3.0V		14	220	nA
			1.8V		11	170	
I _{VCC:ACAL}	Average V _{CC} supply current in Autocalibrated RC oscillator mode	Time keeping mode with only RC oscillator running and Auto-calibration enabled. ACP = 512 seconds ⁽³⁾	3.0V		22	235	nA
			1.8V		18	190	
I _{VCC:CK32}	Additional V _{CC} supply current with CLKOUT at 32.786 kHz	Time keeping mode with XT oscillator running, 32.786 kHz square wave on CLKOUT ⁽⁴⁾	3.0V		3.6	8	μA
			1.8V		2.2	5	
I _{VCC:CK128}	Additional V _{CC} supply current with CLKOUT at 128 Hz	All time keeping modes, 128 Hz square wave on CLKOUT ⁽⁴⁾	3.0V		7	35	nA
			1.8V		2.5	20	

⁽¹⁾ Excluding external peripherals and pull-up resistor current. All other inputs (besides SDA and SCL) are at 0V or V_{CC}. AB1805 only. Test conditions: Continuous burst read/write, 0x55 data pattern, 25 μs between each data byte, 20 pF load on each bus pin.

⁽²⁾ Excluding external peripheral current. All other inputs (besides SDI, nCE and SCL) are at 0V or V_{CC}. AB1815 only. Test conditions: Continuous burst write, 0x55 data pattern, 25 μs between each data byte, 20 pF load on each bus pin.

⁽³⁾ All inputs and outputs are at 0 V or V_{CC}.

⁽⁴⁾ All inputs and outputs except CLKOUT are at 0 V or V_{CC}. 15 pF capacitive load on CLKOUT.



 ABRACON CORPORATION <i>the Power of Linking Together</i>	AB18X5 Real-Time Clock with Power Management Family	 RoHS Compliant
Date of Issue: October 16, 2014	3.0 x 3.0 mm	 ESD Sensitive
<i>Page 17 of 37</i>	Abracon Drawing #453568	Revision: C

Figure 6 shows the typical VCC power state operating current vs. temperature in XT mode.

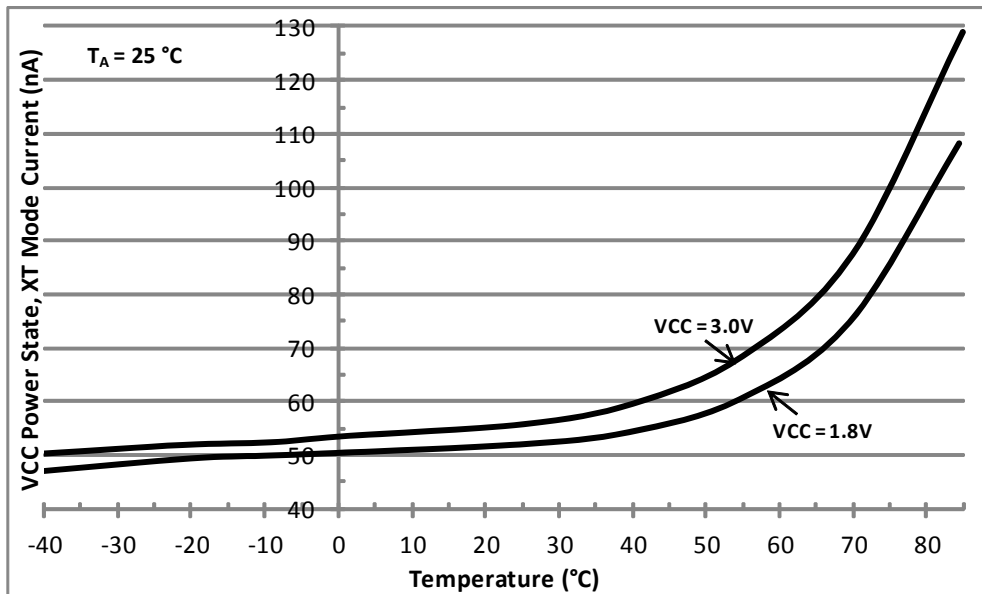

Figure 6. Typical VCC Current vs. Temperature in XT Mode

Figure 7 shows the typical VCC power state operating current vs. temperature in RC mode.

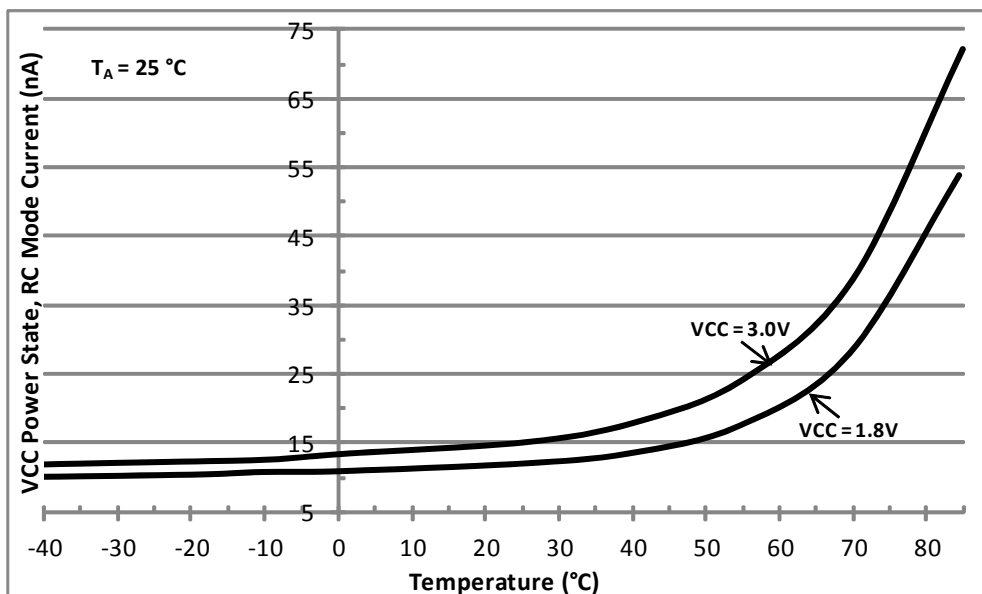

Figure 7. Typical VCC Current vs. Temperature in RC Mode



 ABRACON CORPORATION <i>the Power of Linking Together</i>	AB18X5 Real-Time Clock with Power Management Family	 RoHS Compliant
Date of Issue: October 16, 2014	3.0 x 3.0 mm	 ESD Sensitive
<i>Page 18 of 37</i>	Abracon Drawing #453568	Revision: C

Figure 8 shows the typical VCC power state operating current vs. temperature in RC Autocalibration mode.

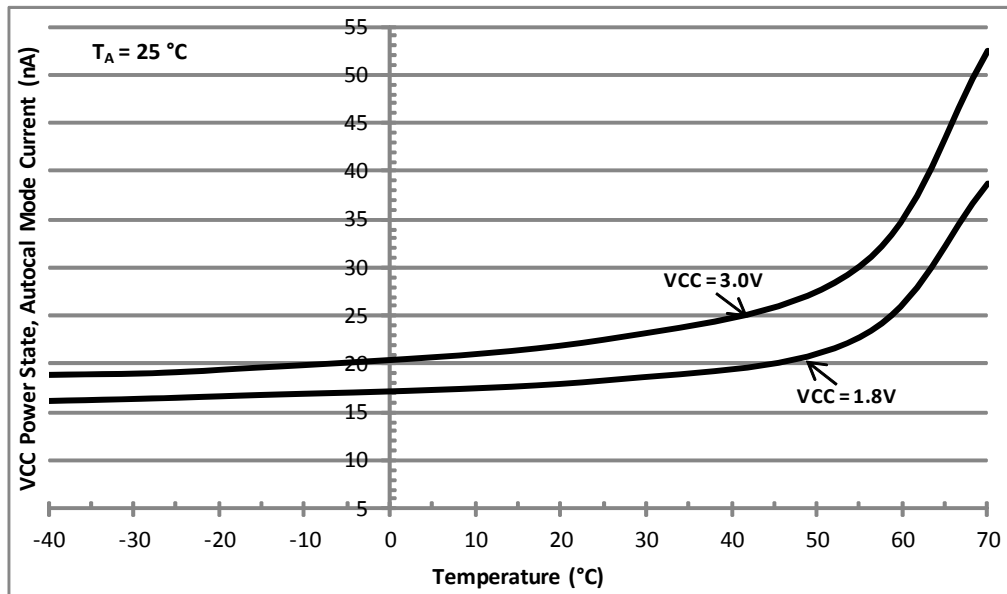

Figure 8. Typical VCC Current vs. Temperature in RC Autocalibration Mode

Figure 9 shows the typical VCC power state operating current vs. voltage for XT Oscillator and RC Oscillator modes and the average current in RC Autocalibrated mode.

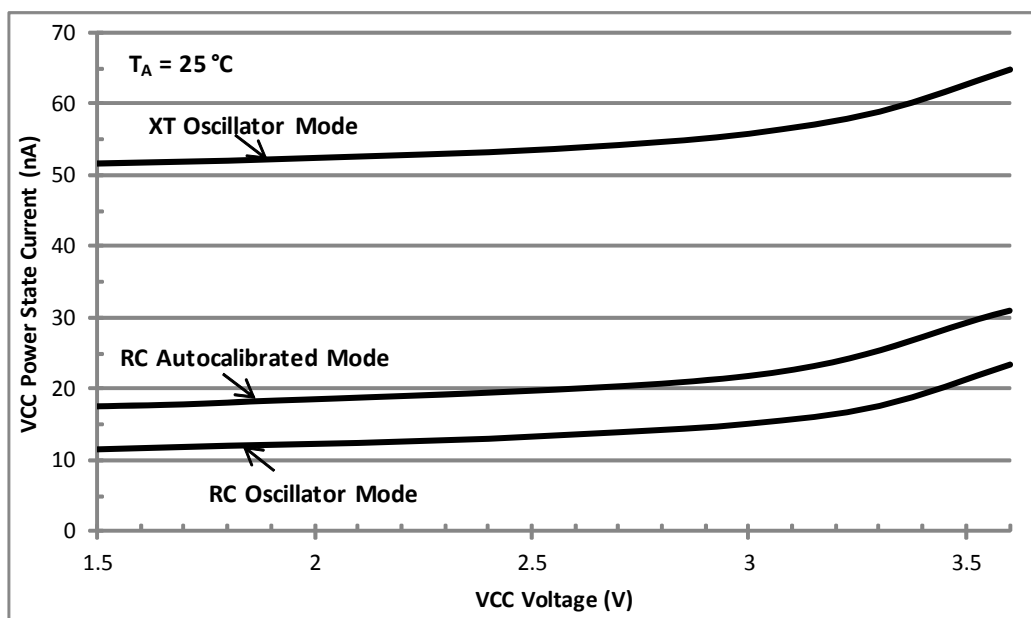

Figure 9. Typical VCC Current vs. Voltage, Different Modes of Operation



 ABRACON CORPORATION <i>the Power of Linking Together</i>	AB18X5 Real-Time Clock with Power Management Family	 RoHS Compliant
Date of Issue: October 16, 2014	3.0 x 3.0 mm	 ESD Sensitive
<i>Page 19 of 37</i>	Abracon Drawing #453568	Revision: C

Figure 10 shows the typical VCC power state operating current during continuous I²C and SPI burst read and write activity. Test conditions: T_A = 25 °C, 0x55 data pattern, 25 μs between each data byte, 20 pF load on each bus pin, pull-up resistor current not included.

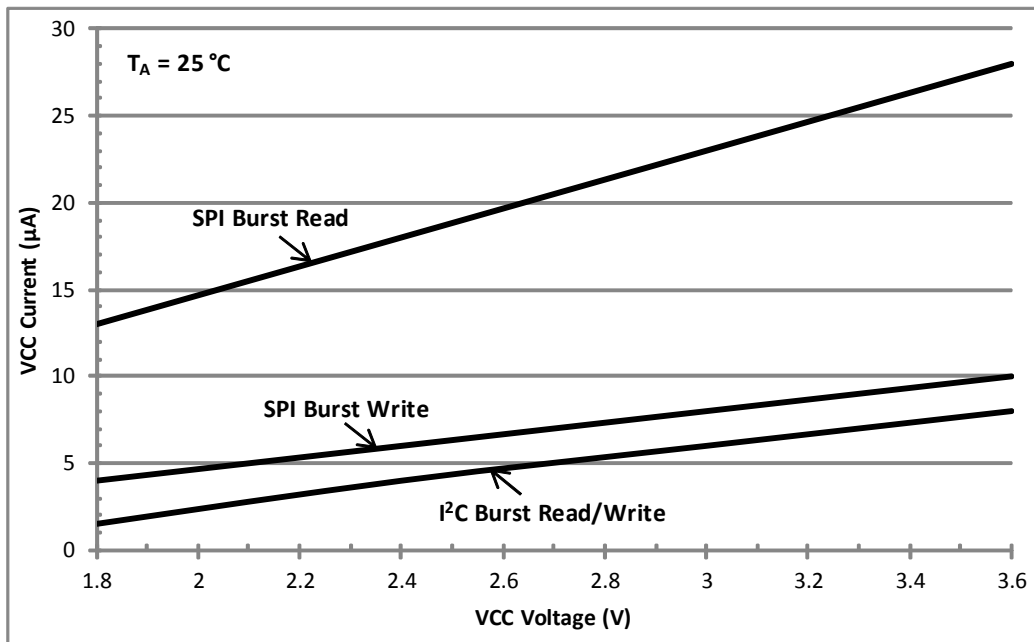

Figure 10. Typical VCC Current vs. Voltage, I²C and SPI Burst Read/Write



 ABRACON CORPORATION <i>the Power of Linking Together</i>	AB18X5 Real-Time Clock with Power Management Family	 RoHS Compliant
Date of Issue: October 16, 2014	3.0 x 3.0 mm	 ESD Sensitive
<i>Page 20 of 37</i>	Abracon Drawing #453568	Revision: C

Figure 11 shows the typical VCC power state operating current with a 32.768 kHz clock output on the CLKOUT pin. Test conditions: $T_A = 25\text{ }^\circ\text{C}$, All inputs and outputs except CLKOUT are at 0 V or VCC. 15 pF capacitive load on the CLKOUT pin.

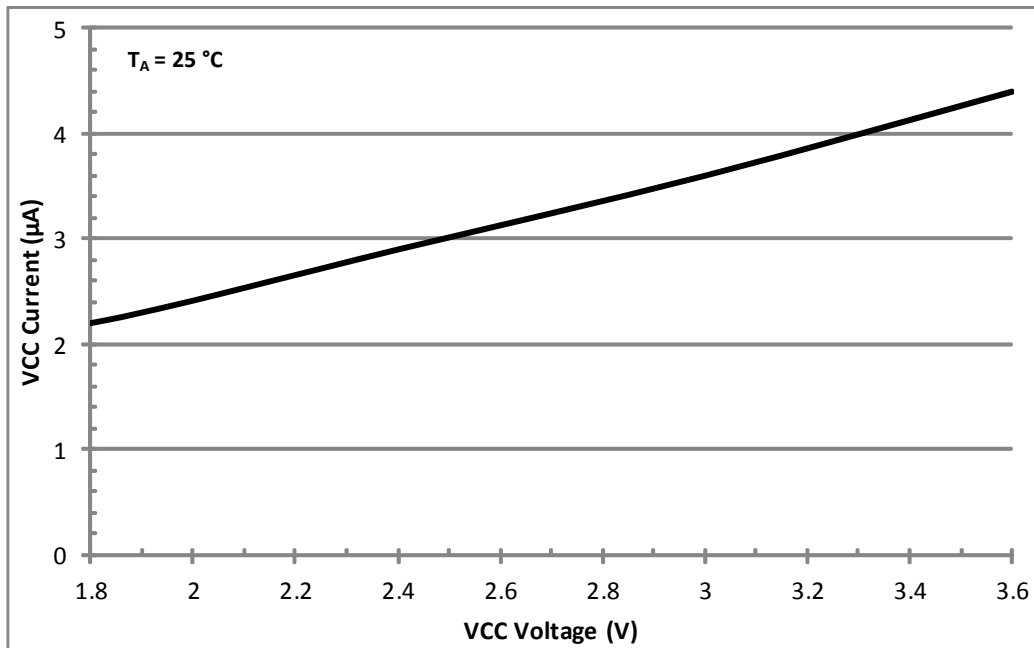





Figure 11. Typical VCC Current vs. Voltage, 32.768 kHz Clock Output

 ABRACON CORPORATION <i>the Power of Linking Together</i>	AB18X5 Real-Time Clock with Power Management Family	 RoHS Compliant
Date of Issue: October 16, 2014	3.0 x 3.0 mm	 ESD Sensitive
<i>Page 21 of 37</i>	Abracon Drawing #453568	Revision: C

5.6 VBAT Supply Current

Table 9 lists the current supplied into the VBAT power input under various conditions.



For Table 9, $T_A = -40\text{ }^{\circ}\text{C}$ to $85\text{ }^{\circ}\text{C}$, TYP values at $25\text{ }^{\circ}\text{C}$, MAX values at $85\text{ }^{\circ}\text{C}$, V_{BAT} Power state.

Table 9: V_{BAT} Supply Current

SYMBOL	PARAMETER	TEST CONDITIONS	V_{CC}	V_{BAT}	MIN	TYP	MAX	UNIT
$I_{VBAT:XT}$	VBAT supply current in XT oscillator mode	Time keeping mode with XT oscillator running ⁽¹⁾	$< V_{CCSWF}$	3.0V		56	330	nA
				1.8V		52	290	
$I_{VBAT:RC}$	VBAT supply current in RC oscillator mode	Time keeping mode with only the RC oscillator running (XT oscillator is off) ⁽¹⁾	$< V_{CCSWF}$	3.0V		16	220	nA
				1.8V		12	170	
$I_{VBAT:ACAL}$	Average VBAT supply current in Autocalibrated RC oscillator mode	Time keeping mode with the RC oscillator running. Autocalibration enabled. ACP = 512 seconds ⁽¹⁾	$< V_{CCSWF}$	3.0V		24	235	nA
				1.8V		20	190	
$I_{VBAT:VCC}$	VBAT supply current in VCC powered mode	V_{CC} powered mode ⁽¹⁾	1.7 - 3.6 V	3.0V	-5	0.6	20	nA
				1.8V	-10	0.5	16	

⁽¹⁾ Test conditions: All inputs and outputs are at 0 V or V_{CC} .

Figure 12 shows the typical VBAT power state operating current vs. temperature in XT mode.

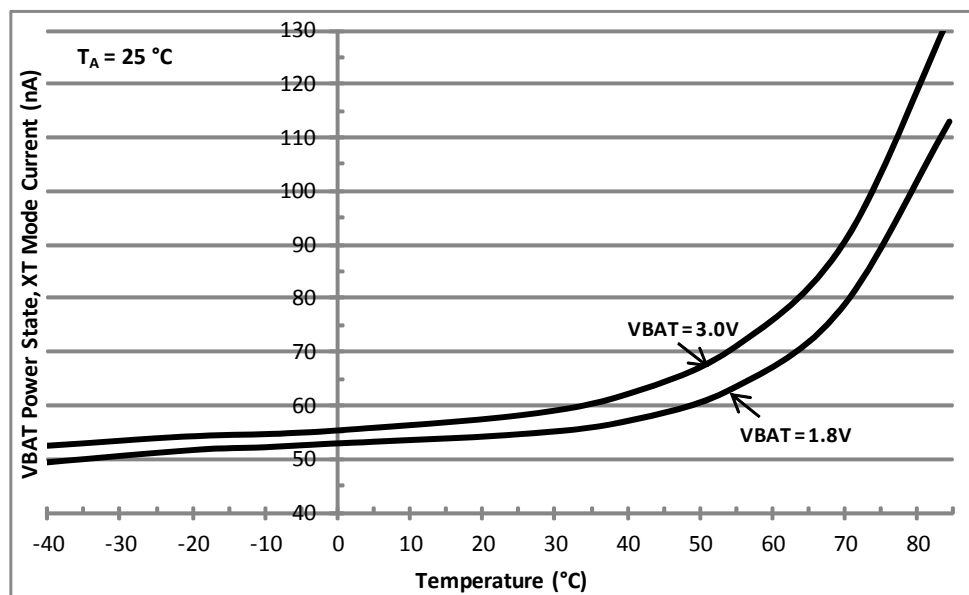

Figure 12. Typical VBAT Current vs. Temperature in XT Mode



 ABRACON CORPORATION <i>the Power of Linking Together</i>	AB18X5 Real-Time Clock with Power Management Family	 RoHS Compliant
Date of Issue: October 16, 2014	3.0 x 3.0 mm	 ESD Sensitive
<i>Page 22 of 37</i>	Abracon Drawing #453568	Revision: C

Figure 13 shows the typical VBAT power state operating current vs. temperature in RC mode.

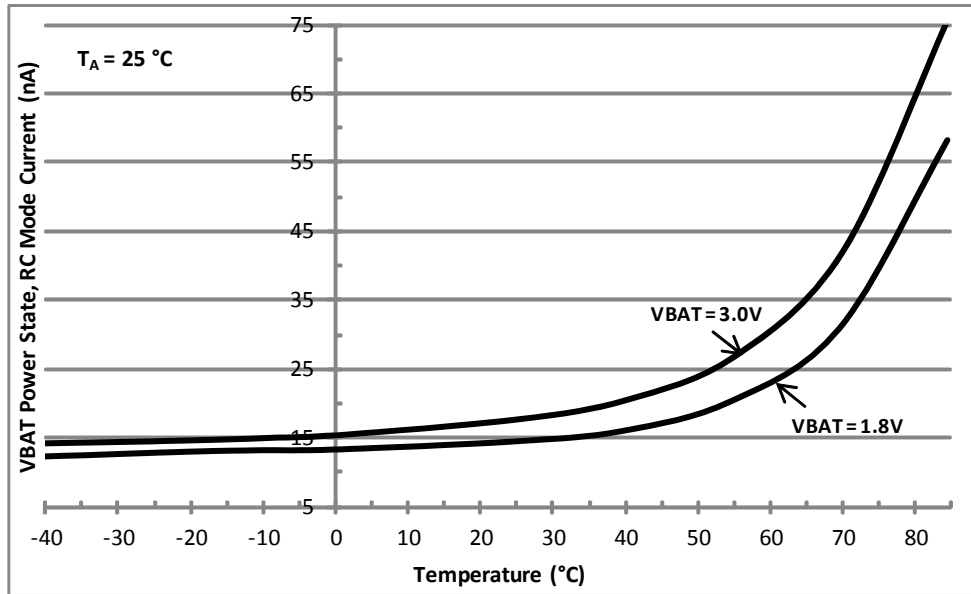

Figure 13. Typical VBAT Current vs. Temperature in RC Mode

Figure 14 shows the typical VBAT power state operating current vs. temperature in RC Autocalibration mode.

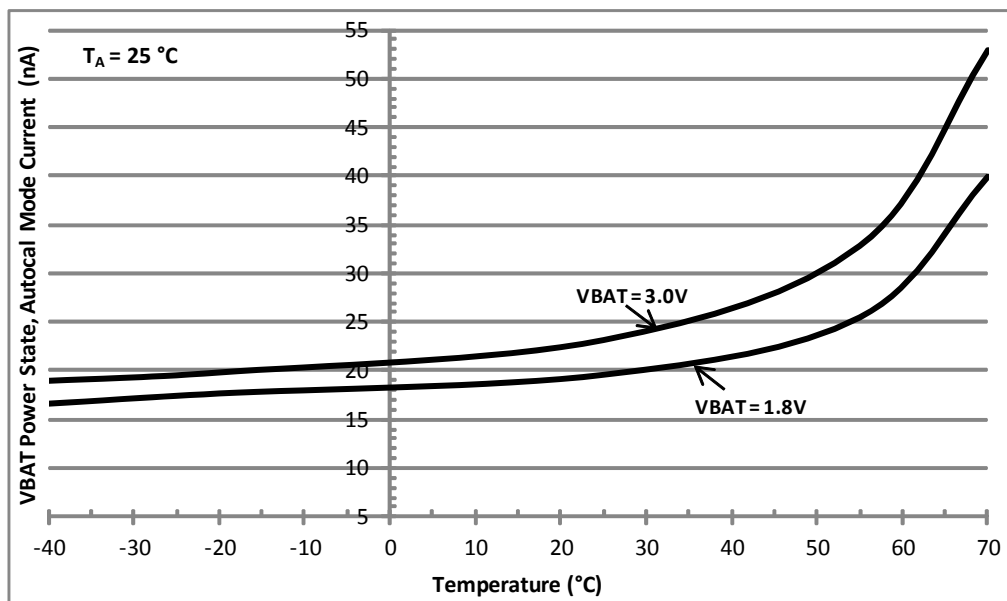

Figure 14. Typical VBAT Current vs. Temperature in RC Autocalibration Mode



 ABRACON CORPORATION <i>the Power of Linking Together</i>	AB18X5 Real-Time Clock with Power Management Family	 RoHS Compliant
Date of Issue: October 16, 2014	3.0 x 3.0 mm	 ESD Sensitive
<i>Page 23 of 37</i>	Abracon Drawing #453568	Revision: C

Figure 15 shows the typical VBAT power state operating current vs. voltage for XT Oscillator and RC Oscillator modes and the average current in RC Autocalibrated mode, VCC = 0 V.

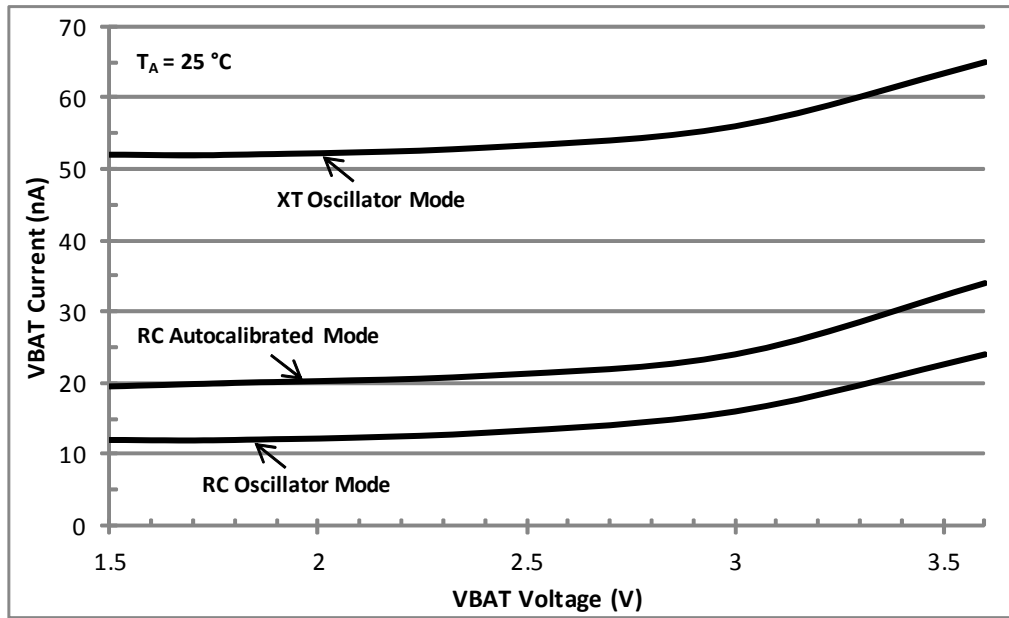

Figure 15. Typical VBAT Current vs. Voltage, Different Modes of Operation

Figure 16 shows the typical VBAT current when operating in the VCC power state, VCC = 1.7 V.

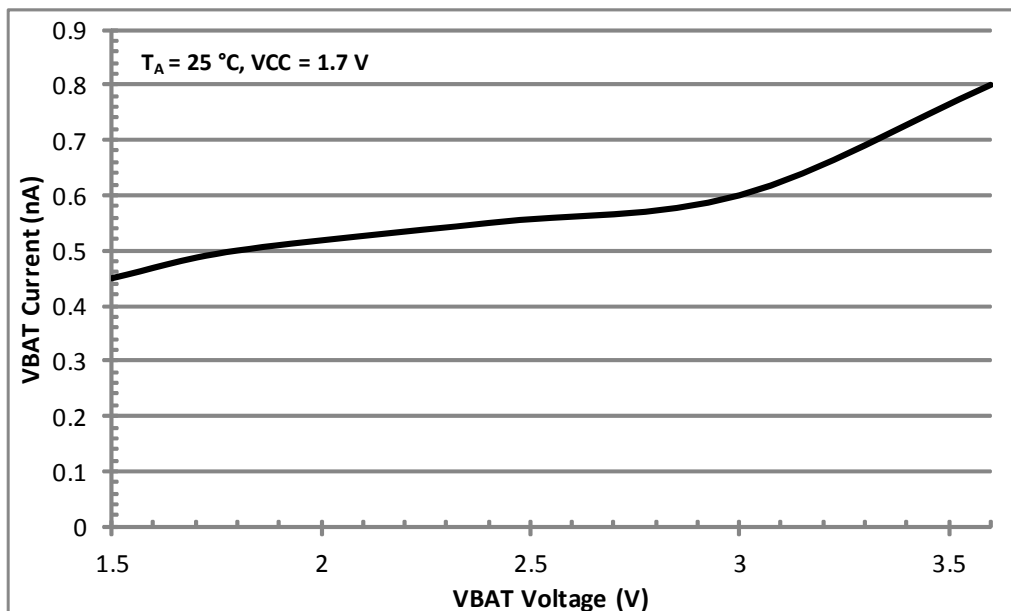





Figure 16. Typical VBAT Current vs. Voltage in VCC Power State

 ABRACON CORPORATION <i>the Power of Linking Together</i>	AB18X5 Real-Time Clock with Power Management Family	 RoHS Compliant
Date of Issue: October 16, 2014	3.0 x 3.0 mm	 ESD Sensitive
<i>Page 24 of 37</i>	Abrakon Drawing #453568	Revision: C

5.7 BREF Electrical Characteristics



Table 10 lists the parameters of the VBAT voltage thresholds. BREF values other than those listed in the table are not supported.



For Table 10, $T_A = -20\text{ }^{\circ}\text{C}$ to $70\text{ }^{\circ}\text{C}$, TYP values at $25\text{ }^{\circ}\text{C}$, $V_{CC} = 1.7$ to 3.6V .

Table 10: BREF Parameters

SYMBOL	PARAMETER	BREF	MIN	TYP	MAX	UNIT
V_{BRF}	VBAT falling threshold	0111	2.3	2.5	3.3	V
		1011	1.9	2.1	2.8	
		1101	1.6	1.8	2.5	
		1111		1.4		
V_{BRR}	VBAT rising threshold	0111	2.6	3.0	3.4	V
		1011	2.1	2.5	2.9	
		1101	1.9	2.2	2.7	
		1111		1.6		
V_{BRH}	VBAT threshold hysteresis	0111		0.5		V
		1011		0.4		
		1101		0.4		
		1111		0.2		
T_{BR}	VBAT analog comparator recommended operating temperature range	All values	-20		70	$^{\circ}\text{C}$

 ABRACON CORPORATION <i>the Power of Linking Together</i>	AB18X5 Real-Time Clock with Power Management Family	 RoHS Compliant
Date of Issue: October 16, 2014	3.0 x 3.0 mm	 ESD Sensitive
<i>Page 25 of 37</i>	Abracon Drawing #453568	Revision: C

5.8 I²C AC Electrical Characteristics

Figure 17 and Table 11 describe the I²C AC electrical parameters.

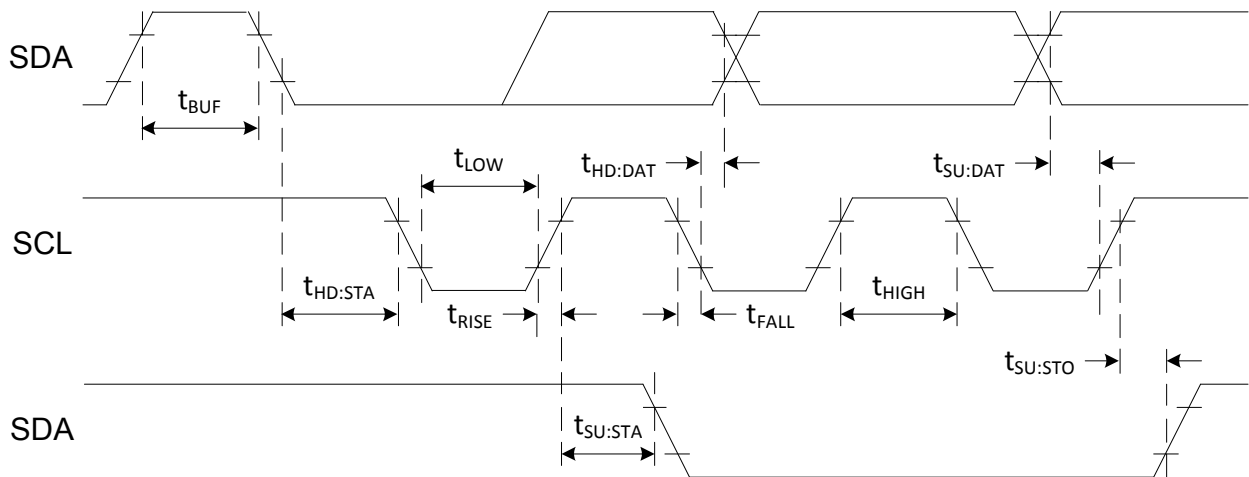





Figure 17. I²C AC Parameter Definitions



For Table 11, $T_A = -40\text{ }^{\circ}\text{C}$ to $85\text{ }^{\circ}\text{C}$, TYP values at $25\text{ }^{\circ}\text{C}$.

Table 11: I²C AC Electrical Parameters

SYMBOL	PARAMETER	VCC	MIN	TYP	MAX	UNIT
f_{SCL}	SCL input clock frequency	1.7V-3.6V	10		400	kHz
t_{LOW}	Low period of SCL clock	1.7V-3.6V	1.3			μs
t_{HIGH}	High period of SCL clock	1.7V-3.6V	600			ns
t_{RISE}	Rise time of SDA and SCL	1.7V-3.6V			300	ns
t_{FALL}	Fall time of SDA and SCL	1.7V-3.6V			300	ns
$t_{HD:STA}$	START condition hold time	1.7V-3.6V	600			ns
$t_{SU:STA}$	START condition setup time	1.7V-3.6V	600			ns
$t_{SU:DAT}$	SDA setup time	1.7V-3.6V	100			ns
$t_{HD:DAT}$	SDA hold time	1.7V-3.6V	0			ns
$t_{SU:STO}$	STOP condition setup time	1.7V-3.6V	600			ns
t_{BUF}	Bus free time before a new transmission	1.7V-3.6V	1.3			μs

 ABRACON CORPORATION <i>the Power of Linking Together</i>	AB18X5 Real-Time Clock with Power Management Family	 RoHS Compliant
Date of Issue: October 16, 2014	3.0 x 3.0 mm	 ESD Sensitive
<i>Page 26 of 37</i>	Abracorn Drawing #453568	Revision: C

5.9 SPI AC Electrical Characteristics

Figure 18, Figure 19, and Table 12 describe the SPI AC electrical parameters.

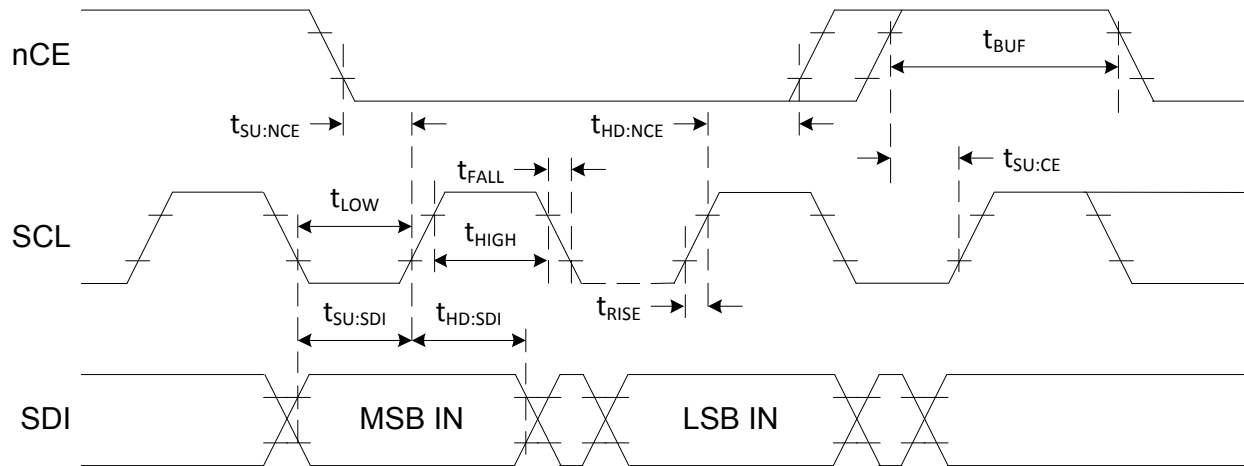

Figure 18. SPI AC Parameter Definitions – Input

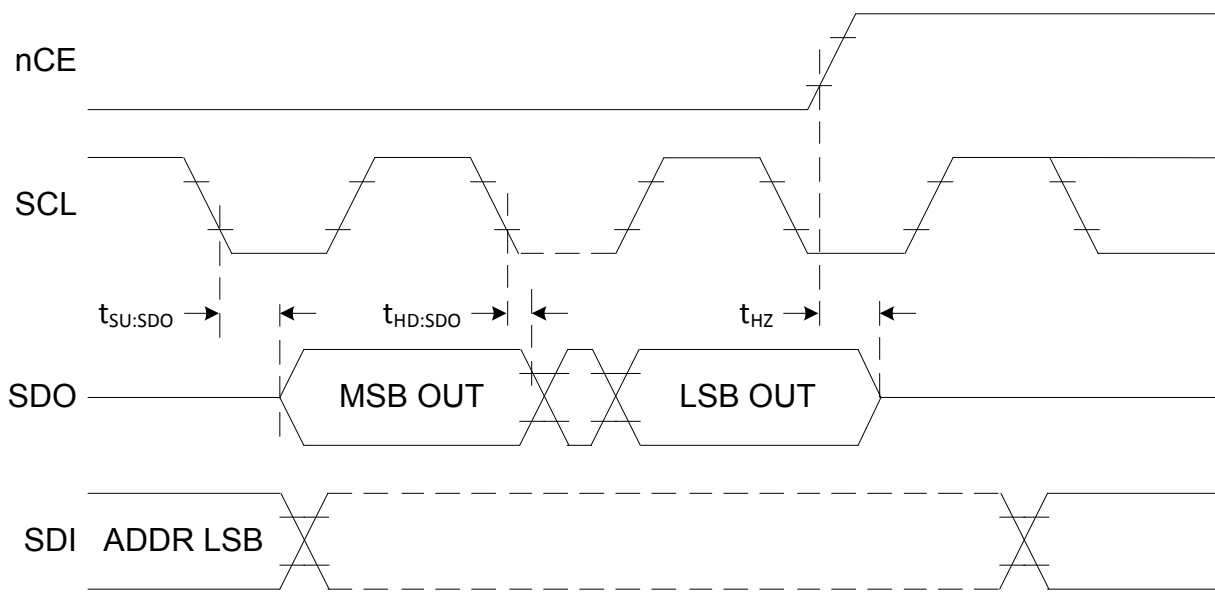

Figure 19. SPI AC Parameter Definitions – Output



For Table 12, $T_A = -40\text{ }^\circ\text{C}$ to $85\text{ }^\circ\text{C}$, TYP values at $25\text{ }^\circ\text{C}$.







 ABRACON CORPORATION <i>the Power of Linking Together</i>	AB18X5 Real-Time Clock with Power Management Family	 RoHS Compliant
Date of Issue: October 16, 2014	3.0 x 3.0 mm	 ESD Sensitive
<i>Page 27 of 37</i>	Abrakon Drawing #453568	Revision: C

Table 12: SPI AC Electrical Parameters

SYMBOL	PARAMETER	VCC	MIN	TYP	MAX	UNIT
f _{SCL}	SCL input clock frequency	1.7V–3.6V	0.01		2	MHz
t _{LOW}	Low period of SCL clock	1.7V–3.6V	200			ns
t _{HIGH}	High period of SCL clock	1.7V–3.6V	200			ns
t _{RISE}	Rise time of all signals	1.7V–3.6V			1	μs
t _{FALL}	Fall time of all signals	1.7V–3.6V			1	μs
t _{SU:NCE}	nCE low setup time to SCL	1.7V–3.6V	200			ns
t _{HD:NCE}	nCE hold time to SCL	1.7V–3.6V	200			ns
t _{SU:CE}	nCE high setup time to SCL	1.7V–3.6V	200			ns
t _{SU:SDI}	SDI setup time	1.7V–3.6V	40			ns
t _{HD:SDI}	SDI hold time	1.7V–3.6V	50			ns
t _{SU:SDO}	SDO output delay from SCL	1.7V–3.6V			150	ns
t _{HD:SDO}	SDO output hold from SCL	1.7V–3.6V	0			ns
t _{HZ}	SDO output Hi-Z from nCE	1.7V–3.6V			250	ns
t _{BUF}	nCE high time before a new transmission	1.7V–3.6V	200			ns

 ABRACON CORPORATION <i>the Power of Linking Together</i>	AB18X5 Real-Time Clock with Power Management Family	 RoHS Compliant
Date of Issue: October 16, 2014	3.0 x 3.0 mm	 ESD Sensitive
<i>Page 28 of 37</i>	Abracron Drawing #453568	Revision: C

5.10 Power On AC Electrical Characteristics

Figure 20 and Table 13 describe the power on AC electrical characteristics for the FOUT pin and XT oscillator.

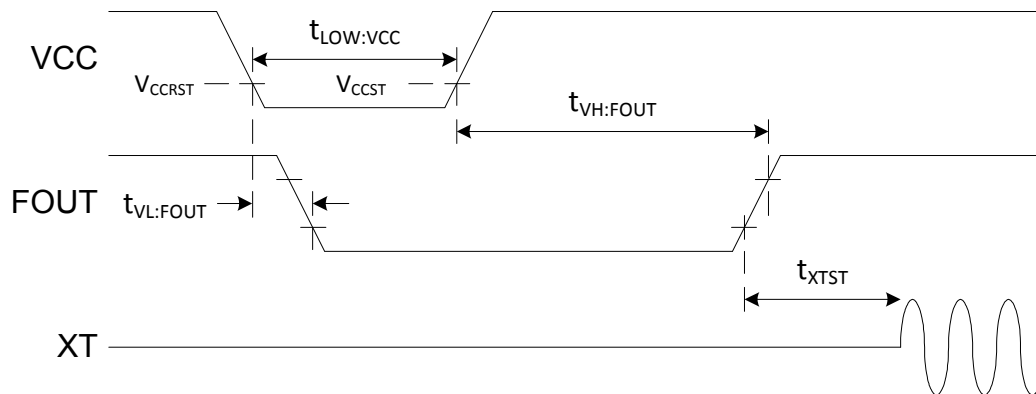





Figure 20. Power On AC Electrical Characteristics



For Table 13, $T_A = -40\text{ }^\circ\text{C}$ to $85\text{ }^\circ\text{C}$, $V_{BAT} < 1.2\text{ V}$

Table 13: Power On AC Electrical Parameters

SYMBOL	PARAMETER	VCC	T_A	MIN	TYP	MAX	UNIT
$t_{LOW:VCC}$	Low period of VCC to ensure a valid POR	1.7V–3.6V	85 °C		0.1		s
			25 °C		0.1		
			-20 °C		1.5		
			-40 °C		10		
$t_{VL:FOUT}$	VCC low to FOUT low	1.7V–3.6V	85 °C		0.1		s
			25 °C		0.1		
			-20 °C		1.5		
			-40 °C		10		
$t_{VH:FOUT}$	VCC high to FOUT high	1.7V–3.6V	85 °C		0.4		s
			25 °C		0.5		
			-20 °C		3		
			-40 °C		20		
t_{XTST}	FOUT high to XT oscillator start	1.7V–3.6V	85 °C		0.4		s
			25 °C		0.4		
			-20 °C		0.5		
			-40 °C		1.5		

	AB18X5 Real-Time Clock with Power Management Family	
Date of Issue: October 16, 2014	3.0 x 3.0 mm	
<i>Page 29 of 37</i>	Abrakon Drawing #453568	Revision: C

5.11 nRST AC Electrical Characteristics

Figure 21 and Table 14 describe the nRST and nEXTR AC electrical characteristics.

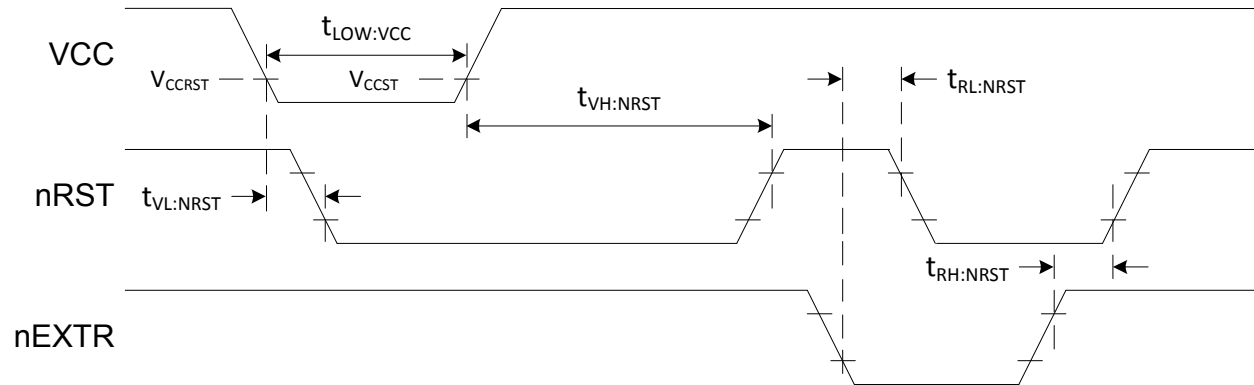





Figure 21. nRST AC Parameter Characteristics



For Table 14, $T_A = -40\text{ }^\circ\text{C}$ to $85\text{ }^\circ\text{C}$, TYP at $25\text{ }^\circ\text{C}$ unless specified otherwise, $V_{BAT} < 1.2\text{ V}$.

Table 14: nRST AC Electrical Parameters

SYMBOL	PARAMETER	VCC	T_A	MIN	TYP	MAX	UNIT
$t_{LOW:VCC}$	Low period of VCC to ensure a valid POR	1.7V-3.6V	85 °C		0.1		s
			25 °C		0.1		
			-20 °C		1.5		
			-40 °C		10		
$t_{VL:NRST}$	VCC low to nRST low	1.7V-3.6V	85 °C		0.1		s
			25 °C		0.1		
			-20 °C		1.5		
			-40 °C		10		
$t_{VH:NRST}$	VCC high to nRST high	1.7V-3.6V	85 °C		0.5		s
			25 °C		0.5		
			-20 °C		3.5		
			-40 °C		25		
$t_{RL:NRST}$	nEXTR low to nRST low	1.7V-3.6V	-40 °C to 85 °C		30	50	ns
$t_{RH:NRST}$	nEXTR high to nRST high	1.7V-3.6V	-40 °C to 85 °C		50	80	ns

 ABRACON CORPORATION <i>the Power of Linking Together</i>	AB18X5 Real-Time Clock with Power Management Family	 RoHS Compliant
Date of Issue: October 16, 2014	3.0 x 3.0 mm	 ESD Sensitive
<i>Page 30 of 37</i>	Abracorn Drawing #453568	Revision: C

6. Tape and Reel Information

REEL DRAWING

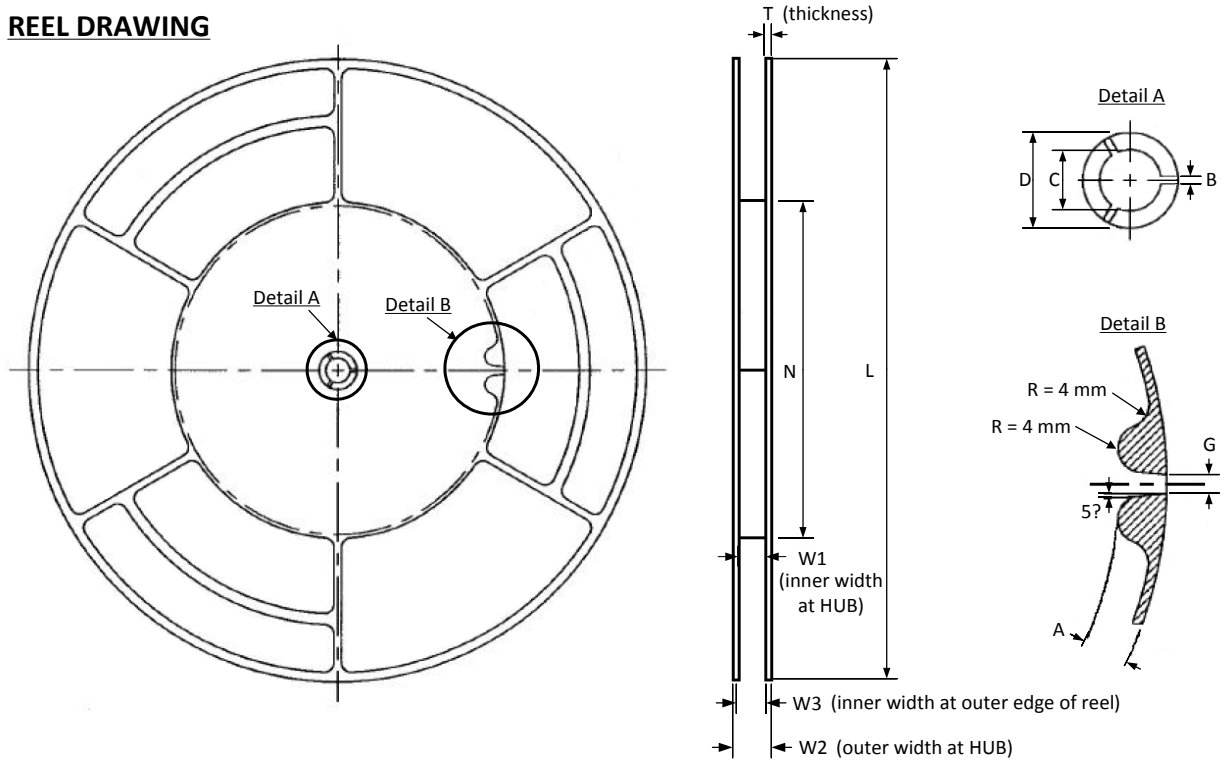

CARRIER TAPE DRAWING

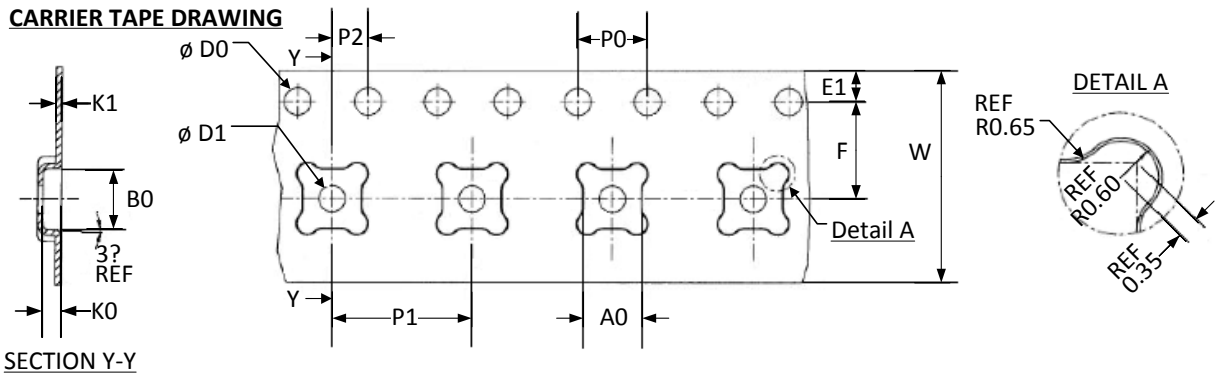







 ABRACON CORPORATION <i>the Power of Linking Together</i>	AB18X5 Real-Time Clock with Power Management Family	 RoHS Compliant
Date of Issue: October 16, 2014	3.0 x 3.0 mm	 ESD Sensitive
<i>Page 31 of 37</i>	Abracon Drawing #453568	Revision: C

Table 15: Tape and Reel Dimensions

330 x 178 x 12 mm Reel Dimensions					3x3 QFN Carrier Tape Dimensions				
Symbol	MIN	TYP	MAX	Units	Symbol	MIN	TYP	MAX	Units
T	2.3	2.5	2.7	mm	B0	3.2	3.3	3.4	mm
N		178.0			K0	0.9	1.0	1.1	
L			330.0		K1	0.25	0.3	0.35	
W1	12.4	12.4	12.6		D0	1.50	1.55	1.60	
W2			18.4		D1	1.5			
W3	12.4		15.4		P0	3.9	4.0	4.1	
C	12.8	13.0	13.5		P1	7.9	8.0	8.1	
D	20.2				P2	1.9	2.0	2.1	
A		10.0			A0	3.2	3.3	3.4	
G		4.0			E1	1.65	1.75	1.85	
B	1.5				F	5.4	5.5	5.6	
					W	11.7	12.0	12.3	

 ABRACON CORPORATION <i>the Power of Linking Together</i>	AB18X5 Real-Time Clock with Power Management Family	 RoHS Compliant
Date of Issue: October 16, 2014	3.0 x 3.0 mm	 ESD Sensitive
<i>Page 32 of 37</i>	Abracorn Drawing #453568	Revision: C

7. Reflow Profile

Figure 22 illustrates the reflow soldering requirements.

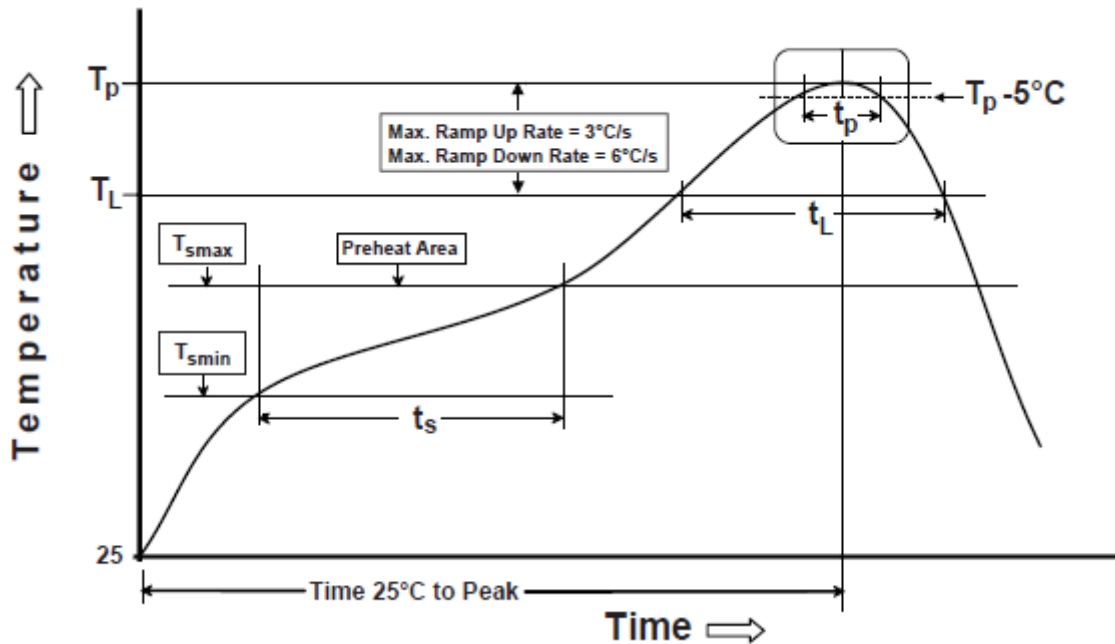





Figure 22. Reflow Soldering Diagram

Table 16: Reflow Soldering Requirements (Pb-free assembly)



Profile Feature	Requirement
Preheat/Soak Temperature Min (T_{smin}) Temperature Max (T_{smax}) Time (t_s) from (T_{smin} to T_{smax})	150 °C 200 °C 60-120 seconds
Ramp-up rate (T_L to T_p)	3 °C/second max.
Liquidous temperature (T_L) Time (t_L) maintained above T_L	217 °C 60-150 seconds
Peak package body temperature (T_p)	260 °C max.
Time (t_p) within 5 °C of T_p	30 seconds max.
Ramp-down rate (T_p to T_L)	6 °C/second max.
Time 25 °C to peak temperature	8 minutes max.

 ABRACON CORPORATION <i>The Power of Linking Together</i>	AB18X5 Real-Time Clock with Power Management Family	 RoHS Compliant
Date of Issue: October 16, 2014	3.0 x 3.0 mm	 ESD Sensitive
<i>Page 33 of 37</i>	Abracon Drawing #453568	Revision: C

8. Ordering Information



Table 17: Ordering Information

AB18X5 Orderable Part Numbers		Package	Temperature Range	MSL Level ⁽²⁾
P/N	Tape and Reel Qty			
AB1805-T3	3000pcs/reel	Pb-Free ⁽¹⁾ 16-Pin QFN 3 x 3 mm	-40 to +85 °C	1
AB1815-T3	3000pcs/reel			
<p>⁽¹⁾ Compliant and certified with the current RoHS requirements for all 6 substances, including the requirement that lead not exceed 0.1% by weight in raw homogeneous materials. The package was designed to be soldered at high temperatures (per reflow profile) and can be used in specified lead-free processes.</p> <p>⁽²⁾ Moisture Sensitivity Level rating according to the JEDEC J-STD-020D.1 industry standard classifications.</p>				

	AB18X5 Real-Time Clock with Power Management Family	 RoHS Compliant
Date of Issue: October 16, 2014	3.0 x 3.0 mm	 ESD Sensitive
<i>Page 34 of 37</i>	Abrakon Drawing #453568	Revision: C

9. Notes



- i. The parts are manufactured in accordance with this specification. If other conditions and specifications which are required for this specification, please contact ABRACON for more information.
- ii. ABRACON will supply the parts in accordance with this specification unless we receive a written request to modify prior to an order placement.
- iii. In no case shall ABRACON be liable for any product failure from inappropriate handling or operation of the item beyond the scope of this specification.
- iv. When changing your production process, please notify ABRACON immediately.
- v. ABRACON Corporation's products are COTS – Commercial-Off-The-Shelf products; suitable for Commercial, Industrial and, where designated, Automotive Applications. ABRACON's products are not specifically designed for Military, Aviation, Aerospace, Life-dependant Medical applications or any application requiring high reliability where component failure could result in loss of life and/or property. For applications requiring high reliability and/or presenting an extreme operating environment, written consent and authorization from ABRACON Corporation is required. Please contact ABRACON Corporation for more information.
- vi. All specifications and Marking will be subject to change without notice.

	AB18X5 Real-Time Clock with Power Management Family	
Date of Issue: October 16, 2014	3.0 x 3.0 mm	
<i>Page 35 of 37</i>	Abracon Drawing #453568	Revision: C

10. ABRACON CORPORATION – TERMS & CONDITIONS OF SALE



The following are the terms and conditions under which Abracon Corporation (“AB”) agrees to sell, to the entity named on the face hereof (“Buyer”), the products specified on the face hereof (the “Products”). Notwithstanding Buyer’s desire to use standardized RFQs, purchase order forms, order forms, acknowledgment forms and other documents which may contain terms in addition to or at variance with these terms, it is expressly understood and agreed that other forms shall neither add to, nor vary, these terms whether or not these terms are referenced therein. Buyer may assent to these terms by written acknowledgment, implication and/or by acceptance or payment of goods ordered any of which will constitute assent.

1. **Prices:** Prices shown on the face hereof are in US dollars, with delivery terms specified herein and are exclusive of any other charges including, without limitation, fees for export, special packaging, freight, insurance and similar charges. AB reserves the right to increase the price of Products by written notice to Buyer at least thirty (30) days prior to the original date of shipment. When quantity price discounts are quoted by AB, the discounts are computed separately for each type of product to be sold and are based upon the quantity of each type and each size ordered at any one time. If any discounted order is reduced by Buyer with AB’s consent, the prices shall be adjusted to the higher prices, if applicable, for the remaining order.
2. **Taxes:** Unless otherwise specified in the quotation, the prices do not include any taxes, import or export duties, tariffs, customs charges or any such other levies. Buyer agrees to reimburse AB the amount of any federal, state, county, municipal, or other taxes, duties, tariffs, or custom charges AB is required to pay. If Buyer is exempt from any such charges, Buyer must provide AB with appropriate documentation.
3. **Payment Terms:** For each shipment, AB will invoice Buyer for the price of the Products plus all applicable taxes, packaging, transportation, insurance and other charges. Unless otherwise stated in a separate agreement or in AB’s quotation, payments are due within thirty (30) days from the date of invoice, subject to AB’s approval of Buyer’s credit application. All invoicing disputes must be submitted in writing to AB within ten (10) days of the receipt of the invoice accompanied by a reasonably detailed explanation of the dispute. Payment of the undisputed amounts shall be made timely. AB reserves the right to require payment in advance or C.O.D. and otherwise modified credit terms. When partial shipments are made, payments for such shipments shall become due in accordance with the above terms upon submission of invoices. If, at the request of Buyer, shipment is postponed for more than thirty (30) days, payment will become due thirty days after notice to Buyer that Products are ready for shipment. Any unpaid due amounts will be subject to interest at one decimal five percent (1.5%) per month, or, if less, the maximum rate allowed by law.
4. **Delivery and Shipment:** Shipment dates are estimates only. Failure to deliver by a specified date shall neither entitle Buyer to any compensation nor impose any liability on AB. AB reserves the right to ship and bill ten percent more or less than the exact quantity specified on the face hereof. All shipments will be made Ex Works as per Incoterms 2000 from AB’s place of shipment. In the absence of specific instructions, AB will select the carrier. Claims against AB for shortages must be made in writing within ten (10) days after the arrival of the shipment. AB is not required to notify Buyer of the shipment. Buyer shall pay all freight charges, insurance and other shipping expenses. Freight charges, insurance and other shipping expenses itemized in advance of actual shipment, if any, are estimates only that are calculated on the basis of standard tariffs and may not reflect actual costs. Buyer must pay actual costs.
5. **Purchase Order Changes and Cancellations:** Purchase orders for standard AB Products may not be canceled within sixty (60) days of the original shipping date. Purchase orders for non-standard AB Products are non-cancelable and non-returnable. All schedule changes must be requested at least thirty (30) days prior to original shipping date. Maximum schedule change “push-out” shall be no more than thirty (30) days from original shipping date. AB may terminate or cancel this order, in whole or in part, at any time prior to the completion of performance by written notice to Buyer without incur-

	AB18X5 Real-Time Clock with Power Management Family	
Date of Issue: October 16, 2014	3.0 x 3.0 mm	
<i>Page 36 of 37</i>	Abracon Drawing #453568	Revision: C

ring any liability to Buyer for breach of contract or otherwise. AB reserves the right to allocate Products in its sole discretion among Buyer and other potential buyers, or defer or delay the shipment of any Product, which is in short supply due to any reason.

6. **Title and Risk of Loss:** AB's responsibility for any loss or damage ends, and title passes, when Products are delivered Ex Works as per Incoterms 2000 at AB's designated shipping location to carrier, to Buyer or to Buyer's agent, whichever occurs first.
7. **Packing:** Packaging shall be AB's standard shipping materials or as specified on the face hereof. Any cost of non-standard packaging and handling requested by Buyer shall be abided by AB provided Buyer gives reasonable prior notice and agrees in writing to pay additional costs.
8. **Security Interest:** Buyer hereby grants AB a purchase money security interest in the Products sold and in the proceeds of resale of such Products until such time as Buyer has paid all charges. AB retains all right and remedies available to AB under the Uniform Commercial Code.
9. **Specifications:** Specifications for each Product are the specifications specified in the published data-sheets of such Product, as of the date of AB's quotation (the "Specifications"). Except as otherwise agreed, AB reserves the right to modify the Specifications at any time without adversely affecting the functionality.
10. **Acceptance:** Unless Buyer notifies AB in writing within ten (10) days from the date of receipt of Products that the Products fail to conform to the Specifications, the Products will be deemed accepted by Buyer. No such claim of non-conformity shall be valid if (i) the Products have been altered, modified or damaged by Buyer, (ii) the rejection notice fails to explain the non-conformance in reasonable detail and is not accompanied by a test report evidencing the non-conformity, or (iii) rejected Products are not returned to AB within thirty (30) days of rejection; provided, that no Product returns may be made without a return material authorization issued by AB.
11. **Limited Warranties and Disclaimers:** AB warrants to Buyer that each Product, for a period of twelve (12) months from shipment date thereof, will conform to the Specifications and be free from defects in materials and workmanship. AB's sole liability and Buyer's exclusive remedy for Products that fail to conform to this limited warranty ("Defective Products") is limited to repair or replacement of such Defective Products, or issue a credit or rebate of no more than the purchase price of such Defective Products, at AB's sole option and election. This warranty shall not apply: (i) if Products have been damaged or submitted to abnormal conditions (mechanical, electrical, or thermal) during transit, storage, installation, or use; or (ii) if Products are subject to Improper Use (as defined below); or (iii) if the non-conformance of Products results from misuse, neglect, improper testing, storage, installation, unauthorized repair, alteration, or excess usage at or beyond the maximum values (temperature limit, maximum voltage, and other Specification limits) defined by AB; (iv) to any other defect not attributable to AB; or (v) removal, alteration, or tampering of the original AB product labeling. This warranty does not extend to Products or components purchased from entities other than AB or AB's authorized distributors or to third-party software or documentation that may be supplied with any Product. In the event no defect or breach of warranty is discovered by AB upon receipt of any returned Product, such Product will be returned to Buyer at Buyer's expense and Buyer will reimburse AB for the transportation charges, labor, and associated charges incurred in testing the allegedly Defective Product. The above warranty is for Buyer's benefit only, and is non-transferable. OTHER THAN THE LIMITED WARRANTY SET FORTH ABOVE, AB MAKES NO WARRANTIES, EXPRESS, STATUTORY, IMPLIED, OR OTHERWISE AND SPECIFICALLY DISCLAIMS THE IMPLIED WARRANTIES OF MERCHANTABILITY, FITNESS FOR A PARTICULAR PURPOSE AND NON-INFRINGEMENT, TO THE MAXIMUM EXTENT PERMITTED BY LAW. WITHOUT LIMITING THE GENERALITY OF THE FOREGOING DISCLAIMERS, AB INCORPORATES BY REFERENCE ANY PRODUCT-SPECIFIC WARRANTY DISCLAIMERS SET FORTH IN THE PUBLISHED PRODUCT DATASHEETS.
12. **Limitation of Liability:** AB SHALL HAVE NO LIABILITY FOR LOSS ARISING FROM ANY CLAIM MADE AGAINST BUYER, OR FOR SPECIAL, INDIRECT, RELIANCE, INCIDENTAL, CONSEQUENTIAL, OR PUNITIVE DAMAGES INCLUDING, WITHOUT LIMITATION, LOSS OF USE, PROFITS, REVENUES, OR COST OF PROCUREMENT OF SUBSTITUTE GOODS BASED ON ANY BREACH

	AB18X5 Real-Time Clock with Power Management Family	
Date of Issue: October 16, 2014	3.0 x 3.0 mm	
<i>Page 37 of 37</i>	Abracon Drawing #453568	Revision: C

OR DEFAULT OF AB, HOWEVER CAUSED, AND UNDER ANY THEORY OF LIABILITY. BUYER'S SOLE REMEDY AND AB'S SOLE AND TOTAL LIABILITY FOR ANY CAUSE OF ACTION, WHETHER IN CONTRACT (INCLUDING BREACH OF WARRANTY) OR TORT (INCLUDING NEGLIGENCE OR MISREPRESENTATION) OR UNDER STATUTE OR OTHERWISE SHALL BE LIMITED TO AND SHALL NOT EXCEED THE AGGREGATE AMOUNTS PAID BY BUYER TO AB FOR PRODUCTS WHICH GIVE RISE TO CLAIMS. BUYER SHALL ALWAYS INFORM AB OF ANY BREACH AND AFFORD AB REASONABLE OPPORTUNITY TO CORRECT ANY BREACH. THE FOREGOING LIMITATIONS SHALL APPLY REGARDLESS OF WHETHER AB HAS BEEN ADVISED OF THE POSSIBILITY OF SUCH DAMAGES AND NOTWITHSTANDING THE FAILURE OF ESSENTIAL PURPOSE OF ANY LIMITED REMEDY.

13. **Improper Use:** Buyer agrees and covenants that, without AB's prior written approval, Products will not be used in life support systems, human implantation, nuclear facilities or systems or any other application where Product failure could lead to loss of life or catastrophic property damage (each such use being an "Improper Use"). Buyer will indemnify and hold AB harmless from any loss, cost, or damage resulting from Improper Use of the Products.
14. **Miscellaneous:** In the event of any insolvency or inability to pay debts as they become due by Buyer, or voluntary or involuntary bankruptcy proceeding by or against Buyer, or appointment of a receiver or assignee for the benefit of creditors of Buyer, AB may elect to cancel any unfulfilled obligations. No Products or underlying information or technology may be exported or re-exported, directly or indirectly, contrary to US law or US Government export controls. AB will be excused from any obligation to the extent performance thereof is caused by, or arises in connection with, acts of God, fire, flood, riots, material shortages, strikes, governmental acts, disasters, earthquakes, inability to obtain labor or materials through its regular sources, delay in delivery by AB's supplies or any other reason beyond the reasonable control of AB. In the event any one or more of the provisions contained herein shall for any reason be held to be invalid, illegal, or unenforceable in any respect, such invalidity, illegality, or unenforceability shall not affect any other provision hereof and these terms shall be construed as if such invalid, illegal, or unenforceable provision had never been contained herein. A waiver of a breach or default under these terms shall not be a waiver of any subsequent default. Failure of AB to enforce compliance with any of these terms shall not constitute a waiver of such terms. These terms are governed by the laws of the State of California without reference to conflict of law principles. The federal and state courts located within the State of California will have exclusive jurisdiction to adjudicate any dispute arising out of these terms.