

# SPECIFICATIONS

"Preliminary data"



**Model Number:** CR0512UB-G70(T)  
**Part Number:** 17000190A

**Version:**  
Apr 11, 2017

## Mechanical Drawing:

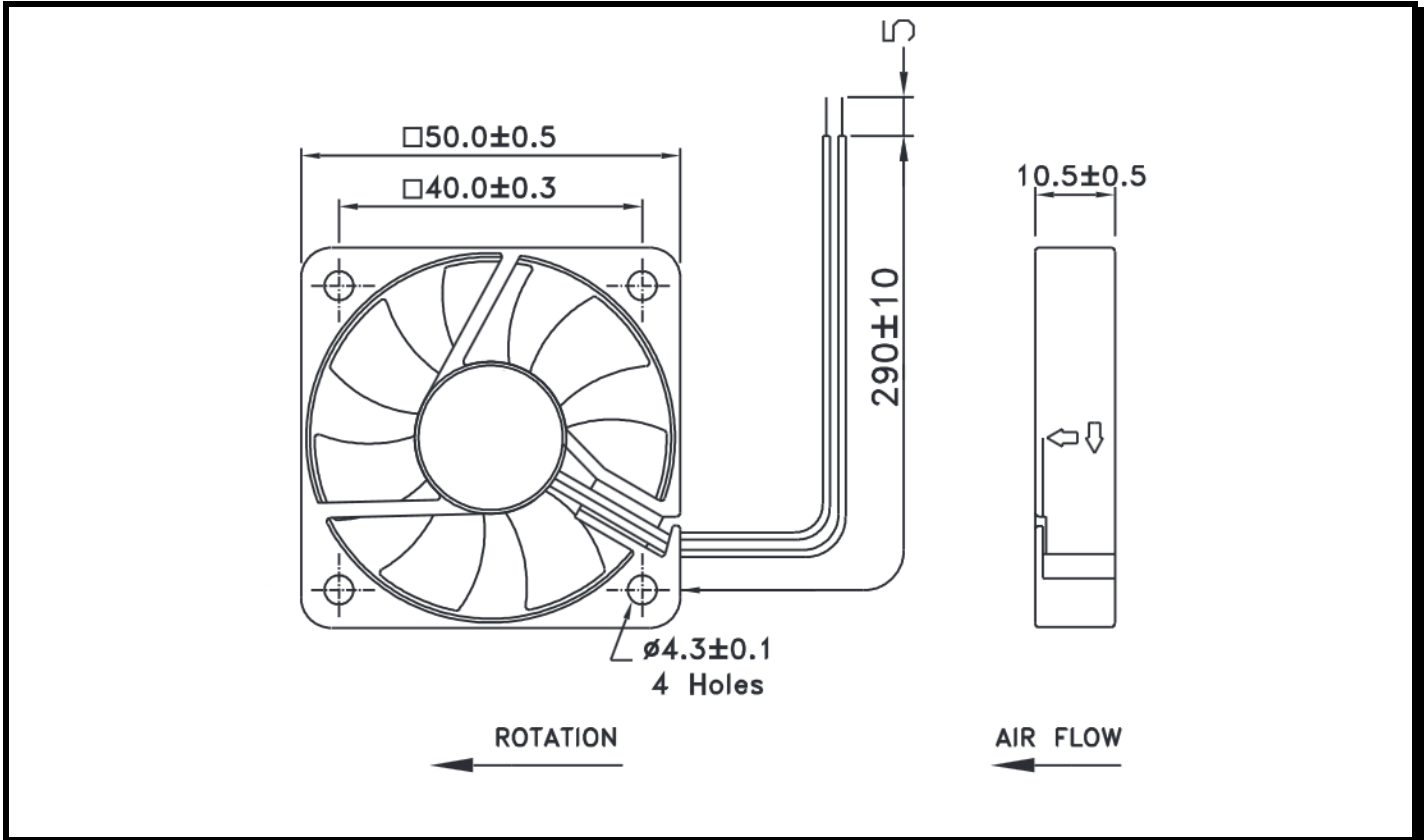

### Motor:

Nominal Voltage	= 12 VDC
Nominal Running Current	= 0.10 Amps
Power Input	= 1.20 Watts
Speed	= 5600 RPM
Bearings	= Ball
Air Flow	= 12.0 CFM
Static Pressure:	= 0.12 Inch of H <sub>2</sub> O
Acoustic	= 32.0 dB(A)
Weight	= 18.0 g

### Construction:

Housing: UL94V-0 Glass Filled Polyester (P.B.T)  
Impeller: UL94V-0 Glass Filled Polyester (P.B.T)

### Life Expectancy:

This fan is designed for continuous duty life of 70,000 hours at 40°C.

### Additional Features:

Brushless DC Motor  
Locked Rotor Protection  
Polarity Protected  
Automatic Restart Capability  
Operating Temperature: -10° C to 70° C  
Storage Temperature: -40° C to 70° C

### Termination:

290 ± 10 mm Lead wires, AWG 26, UL 1007

### Agency Approvals:

UL, CUL, TUV, CE