

DESCRIPTION: M8 FEMALE - PANEL MOUNT (FRONT) - SOLDER CUP - 6 POS.

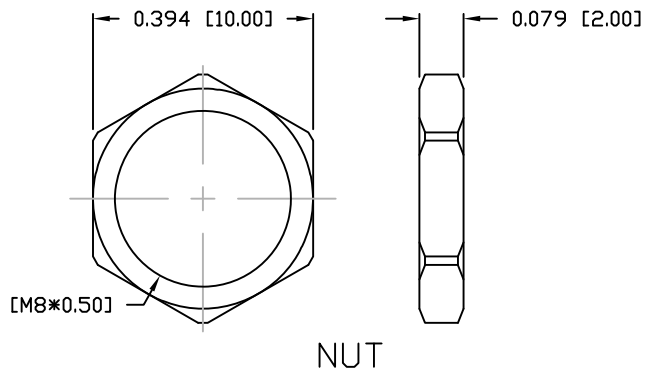

NOTE:

MATERIAL	
HOUSING:	PBT UL94V-0, BLACK
CONTACT:	BRASS
SHELL:	BRASS
NUT:	BRASS
O-RING:	EPDM, BLACK
FINISH:	
CONTACT:	GOLD PLATED OVER 50µ" NICKEL
SHELL:	NICKEL
NUT:	NICKEL
ELECTRICAL	
RATED CURRENT:	1.5A
RATED VOLTAGE:	30V
INSULATION RESISTANCE:	100 MΩhms MIN.
CONTACT RESISTANCE:	10 mΩhms MAX.
WATER PROOF:	IP67
ENVIRONMENT	
OPERATION TEMPERATURE:	-40°C TO +85°C
MAX WIRE AWG:	26

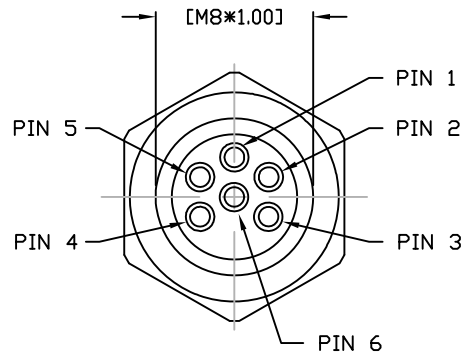
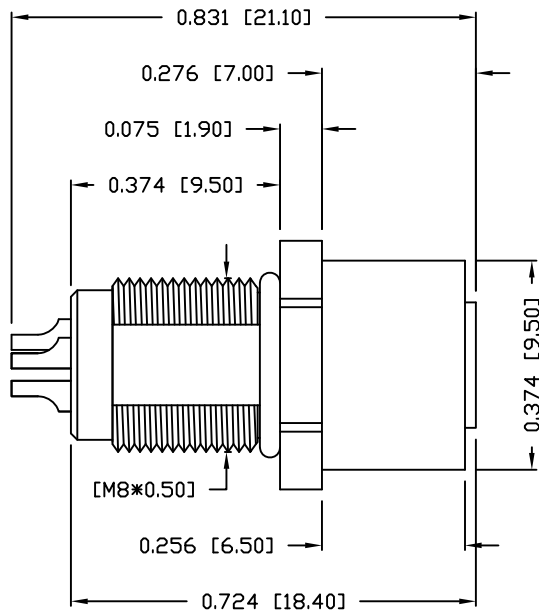

855-006-203R00Y

1 = GOLD FLASH
4 = 10µ" GOLD

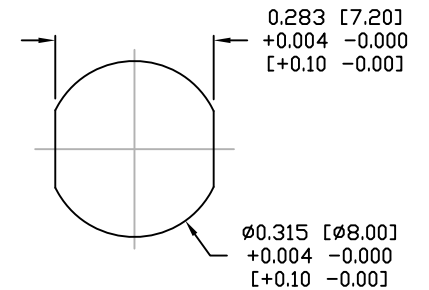

RoHS COMPLIANT

UNITS = INCHES [MM]

DO NOT SCALE FROM DRAWING



THESE DRAWINGS AND SPECIFICATIONS ARE THE PROPERTY OF NorComp AND SHALL NOT BE REPRODUCED, COPIED OR USED AS THE BASIS FOR THE MANUFACTURE OR SALE OF APPARATUS WITHOUT WRITTEN PERMISSION.

DRAWN:

M. SIGMON

DATE:

03-04-16

NorComp

SCALE:

NTS

SHEET

1

OF

1

REV

3

DWG NO.

855-006-203R00Y