

DATE	REV	ECN	APP'D. BY
11/3/00	B0	3903	TRM
6/27/01	B1	5104	TRM
2/3/06	B2	7458	JM
6-27-06	B3	7581	TRM

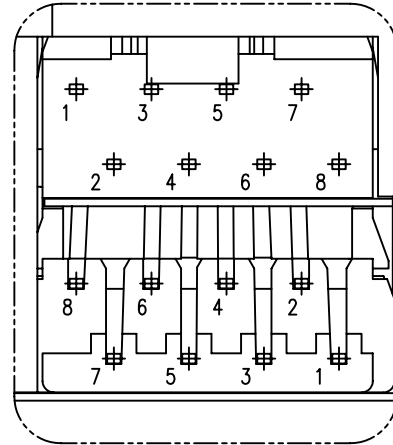
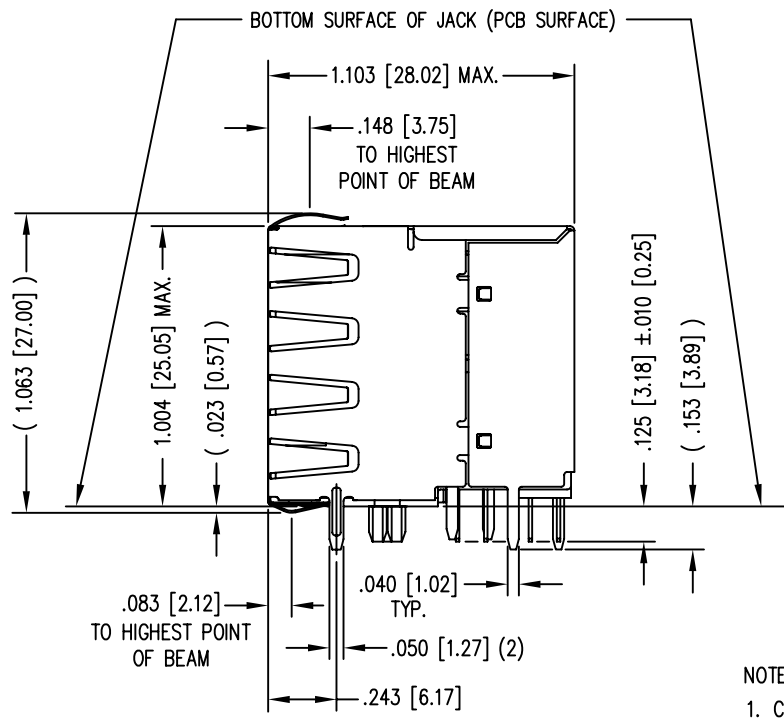
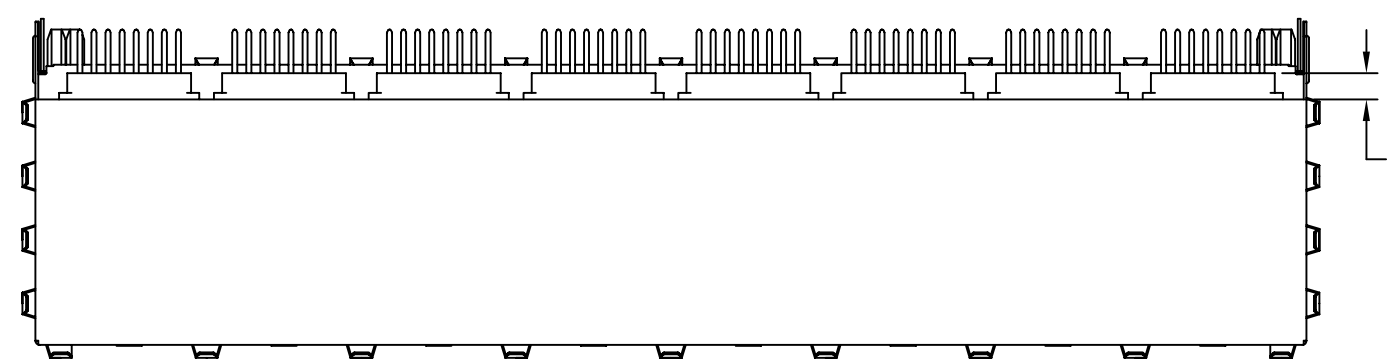
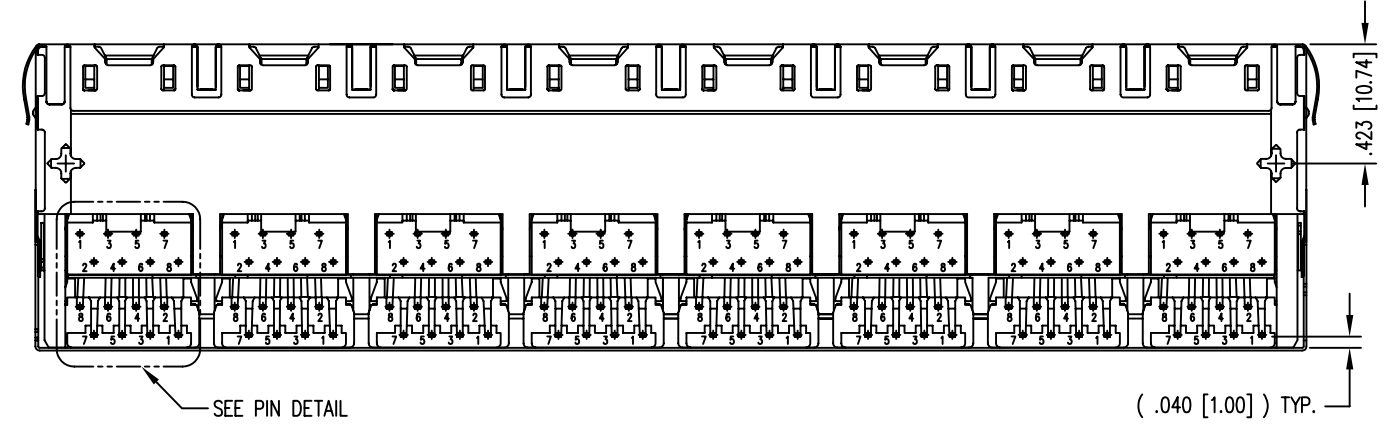
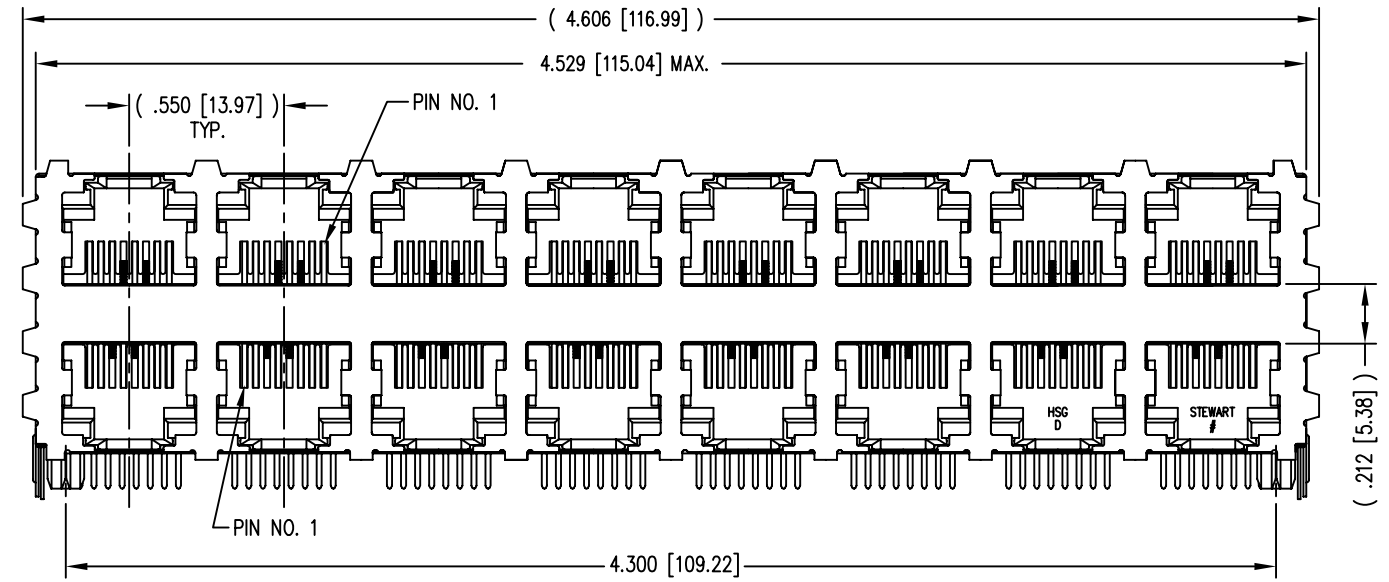

PIN DETAIL
TYP. ALL PORTS

NOTES:

- CONNECTOR MATERIALS:
HOUSING: THERMOPLASTIC UL94 V-0
CONTACTS/SHIELD: COPPER ALLOY
CONTACT PLATING: SELECTIVE GOLD IN CONTACT AREA
SEE CHART FOR PART NUMBER
SHIELD PLATING: NICKEL OR TIN
- FOR PRODUCT SPECIFICATION SEE PR022-01.
- DIMENSIONS AND TOLERANCES COMPLY WITH FCC/CFR 47, PART 68.
- THE SUGGESTED PANEL OPENING IS INTENDED TO GIVE USER THE ABILITY TO HAVE REASONABLE JACK/PANEL CLEARANCES, YET MAINTAIN GROUNDING CAPABILITY. THESE VARIABLES CAN BE ADJUSTED IN EITHER DIRECTION BUT MAY CARRY SOME CONSEQUENCES IN THE FORM OF LOWER MATING FORCES OR TIGHTER ASSEMBLY TOLERANCES.
- DESIGNED FOR CATEGORY 5/5e APPLICATIONS.

50 MICRO-INCHES [1.27um]	SS-73100-034
CONTACT PLATING IN MATING AREA	PART NUMBER

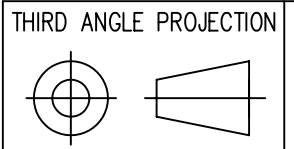

DO NOT SCALE DRAWING
DRAWING IS SUBJECT TO
CHANGE WITHOUT NOTICE

DIMENSIONS: INCHES [METRIC]

UNLESS OTHERWISE SPECIFIED
TOLERANCES ARE ±.005 [0.13]
ANGLES ARE ± 1°

SHEET NO. 1 OF 2



Bel Stewart Connector

11118 Susquehanna Trail South
Glen Rock, PA 17327-9199
(717) 235-7512 Fax: (717) 235-7954 <http://www.stewartconnector.com>

TITLE: HIGH PERFORMANCE SHIELDED STACK JACK, 16 PORTS (8 ON 8)
EIGHT CONTACT, EIGHT POSITION, 50 MICROINCHES GOLD

THIS DRAWING AND THE SUBJECT MATTER SHOWN THEREON ARE CONFIDENTIAL AND THE PROPRIETARY PROPERTY OF BEL STEWART CONNECTOR AND SHALL NOT BE REPRODUCED, COPIED, OR USED IN ANY MANNER WITHOUT PRIOR WRITTEN CONSENT OF BEL STEWART CONNECTOR. THE SUBJECT MATTER MAY BE PATENTED OR A PATENT MAY BE PENDING.	DRN BY: JAF	DATE: 7-22-98
	APPD BY: TRM	DATE: 7-23-98
	DWG NO. CT730100	REV. B3

B

B

A

A

B

B

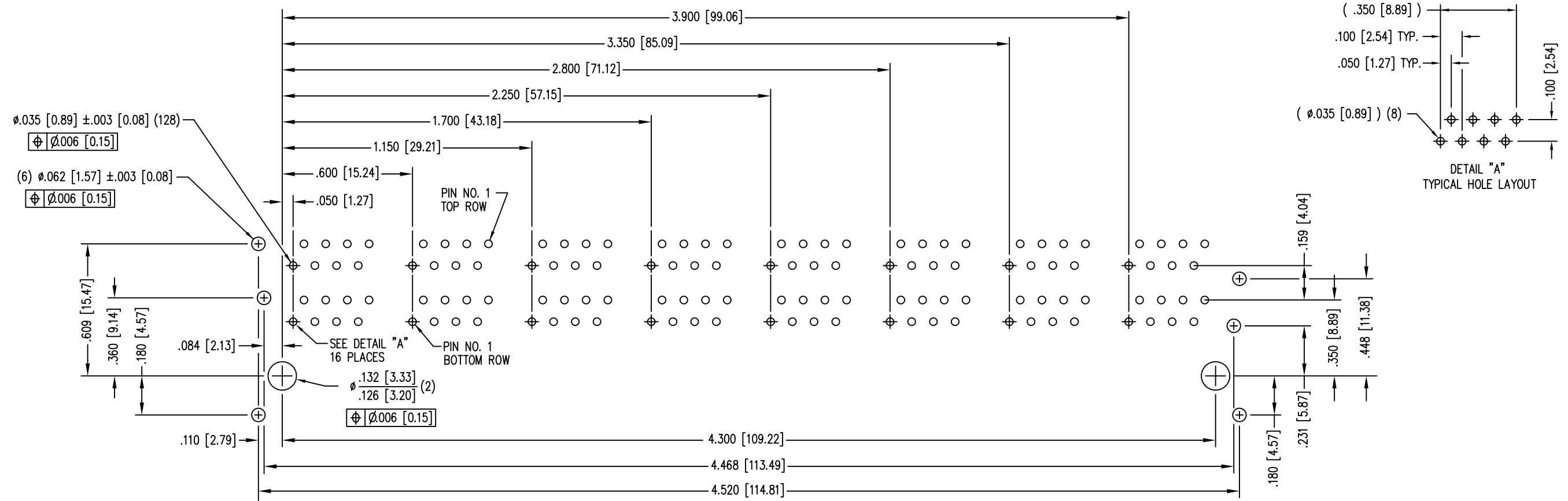

P.C.B. RECOMMENDED HOLE LAYOUT
 SEEN FROM COMPONENT SIDE
 ALL CENTERLINE DIMENSIONS ARE BASIC.

A

A

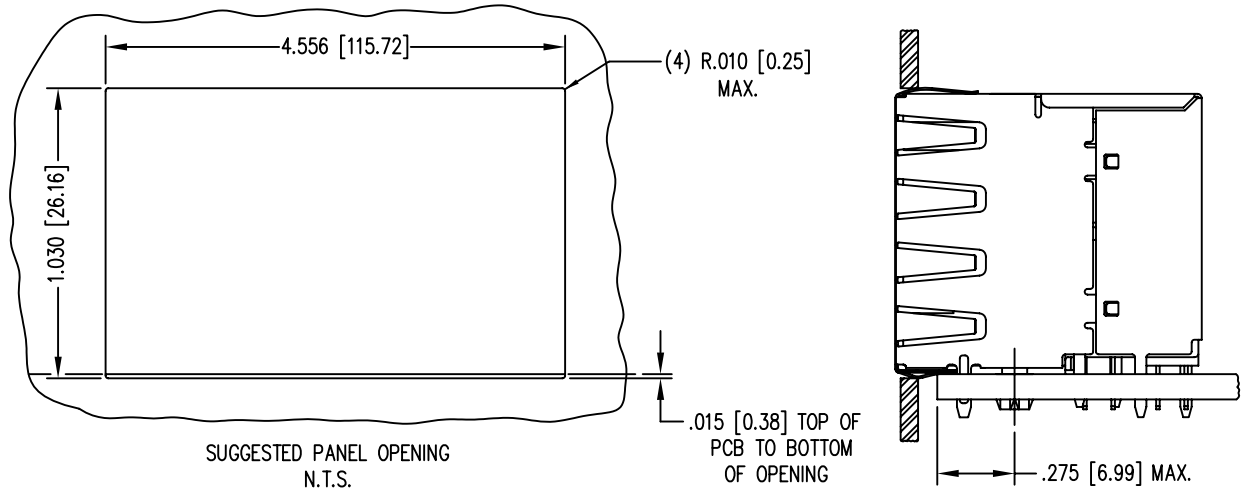

THIRD ANGLE PROJECTION	
DO NOT SCALE DRAWING DRAWING IS SUBJECT TO CHANGE WITHOUT NOTICE	
DIMENSIONS: INCHES [METRIC]	
UNLESS OTHERWISE SPECIFIED TOLERANCES ARE $\pm .005 [0.13]$ ANGLES ARE $\pm 1^\circ$	
SHEET NO.	2 OF 2

<h1>Bel Stewart Connector</h1>			
11118 Susquehanna Trail South Glen Rock, PA 17327-9199 (717) 235-7512 Fax: (717) 235-7954 http://www.stewartconnector.com			
TITLE: HIGH PERFORMANCE SHIELDED STACK JACK, 16 PORTS (8 ON 8) EIGHT CONTACT, EIGHT POSITION, 50 MICROINCHES GOLD			
DRN BY:	JAF	DATE	7-22-98
APPD BY:	TRM	DATE	7-23-98
DWG NO.	CT730100	REV.	B3

REV. 6/3/05