

## END-LOOK PACKAGE LIGHT EMITTING DIODE

### ● Features:

1. High radiant power and high radiant intensity.
2. Standard T-1 package.
3. Peak wavelength  $\lambda_p=940\text{nm}$ .
4. Good spectral matching to si-photodetector.
5. Radiant angle:  $35^\circ$
6. Lens Appearance: Water Clear.
7. This product doesn't contain restriction substance, comply RoHS standard

### ● Applications:

1. Remote Control.
2. Automatic Control System.

### ● Absolute Maximum Ratings( $T_a=25^\circ\text{C}$ )

Parameter	Symbol	Rating	Unit
Power Dissipation	$P_d$	150	mW
Forward Current	$I_F$	100	mA
Peak Forward Current <sup>*1</sup>	$I_{FP}$	1.0	A
Reverse Voltage	$V_R$	5	V
Operating Temperature	$T_{opr}$	$-40^\circ\text{C} \sim 85^\circ\text{C}$	-
Storage Temperature	$T_{stg}$	$-45^\circ\text{C} \sim 85^\circ\text{C}$	-

<sup>\*1</sup> (300pps 10us pulse)

### ● Package Dimensions:

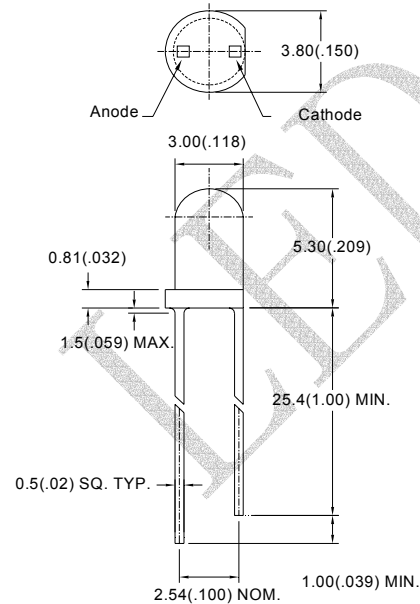

#### NOTES:

1. All dimensions are in millimeters (inches).
2. Tolerance is  $\pm 0.25\text{mm}$  (0.01') unless otherwise specified.
3. Lead spacing is measured where the leads emerge from the package.
4. Specifications are subject to change without notice.

● **Optical- Electrical Characteristics (@ $T_A=25^\circ\text{C}$ )**

Parameter	Symbol	Test Conditions	Min	TYP	Max	Unit
Radiant Intensity	$I_e$	$I_F=50\text{mA}$	9.90	25	-	mW/sr
Forward Voltage	$V_F$	$I_F=50\text{mA}$	-	1.25	1.50	V
Reverse Current	$I_R$	$V_R=5\text{V}$	-	-	100	$\mu\text{A}$
Peak Wavelength	$\lambda_p$	$I_F=50\text{mA}$	-	940	-	nm
Spectral Line Half- Width	$\Delta\lambda$	$I_F=50\text{mA}$	-	50	-	nm
Viewing Angle	$2\theta_{1/2}$	$I_F=20\text{mA}$	-	35	-	deg

● **Typical Optical-Electrical Characteristic Curves**

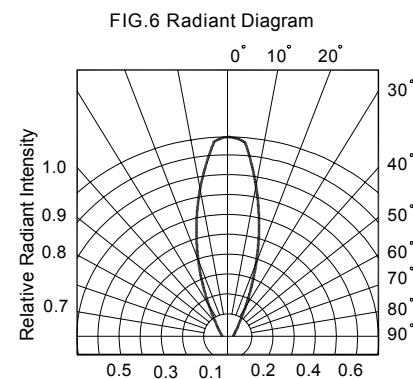
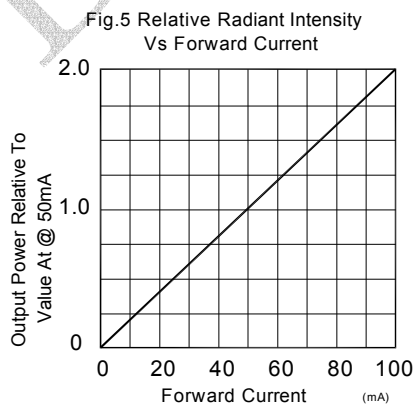
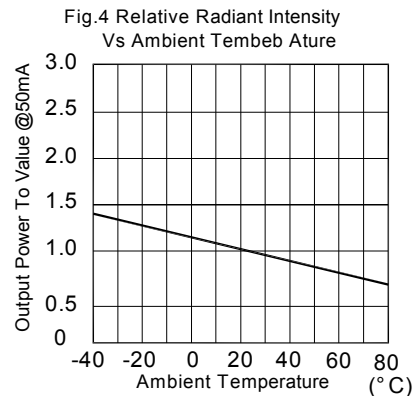
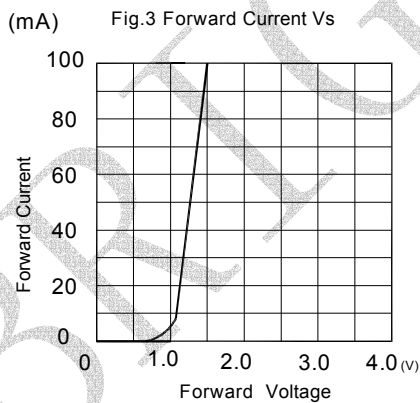
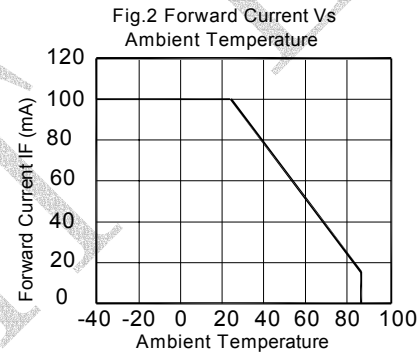
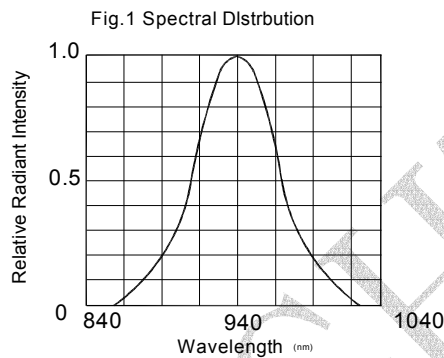

## ● Dip Soldering

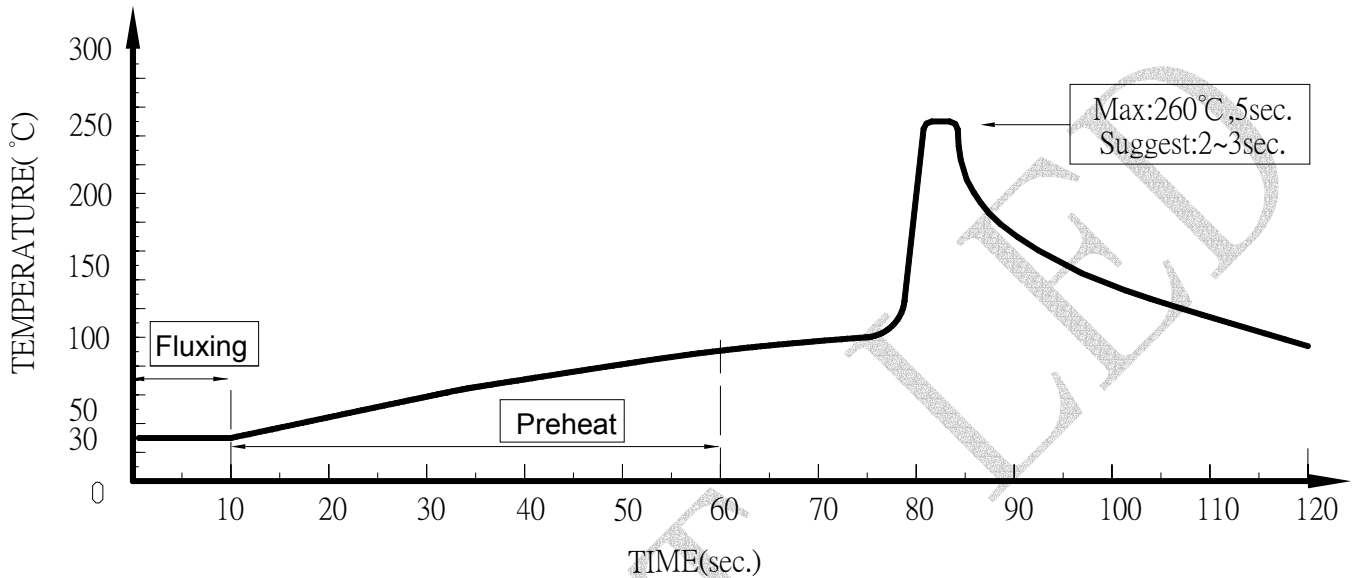

1. Please avoid any external stress applied to the lead-frames and epoxy while the LEDs are at high temperature, especially during soldering
2. DIP soldering and hand soldering should not be done more than one time.
3. After soldering, avoid the epoxy lens from mechanical shock or vibration until the LEDs are back to room temperature.
4. Avoid rapid cooling during temperature ramp-down process
5. Although the soldering condition is recommended above, soldering at the lowest possible temperature is feasible for the LEDs

## ● IRON Soldering

**300°C Within 3 sec., One time only.**

● Tapping and packaging specifications(Units: mm)

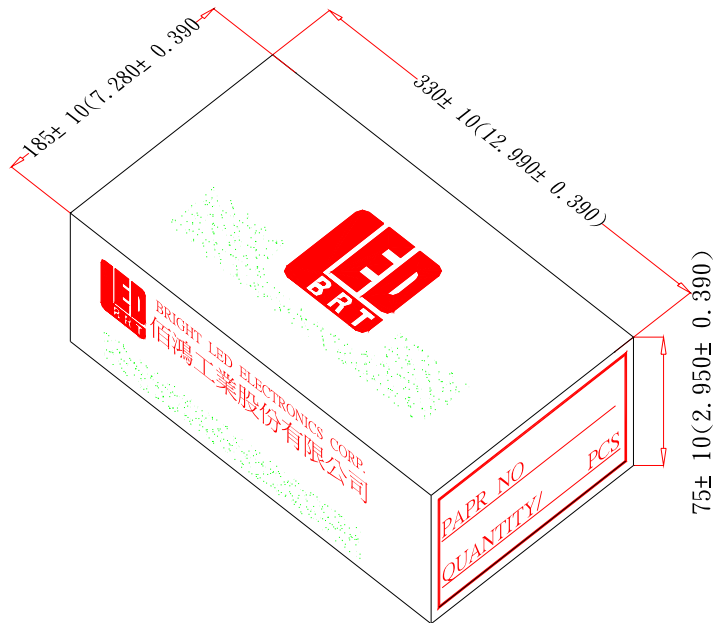

● Packaging Bag Dimensions

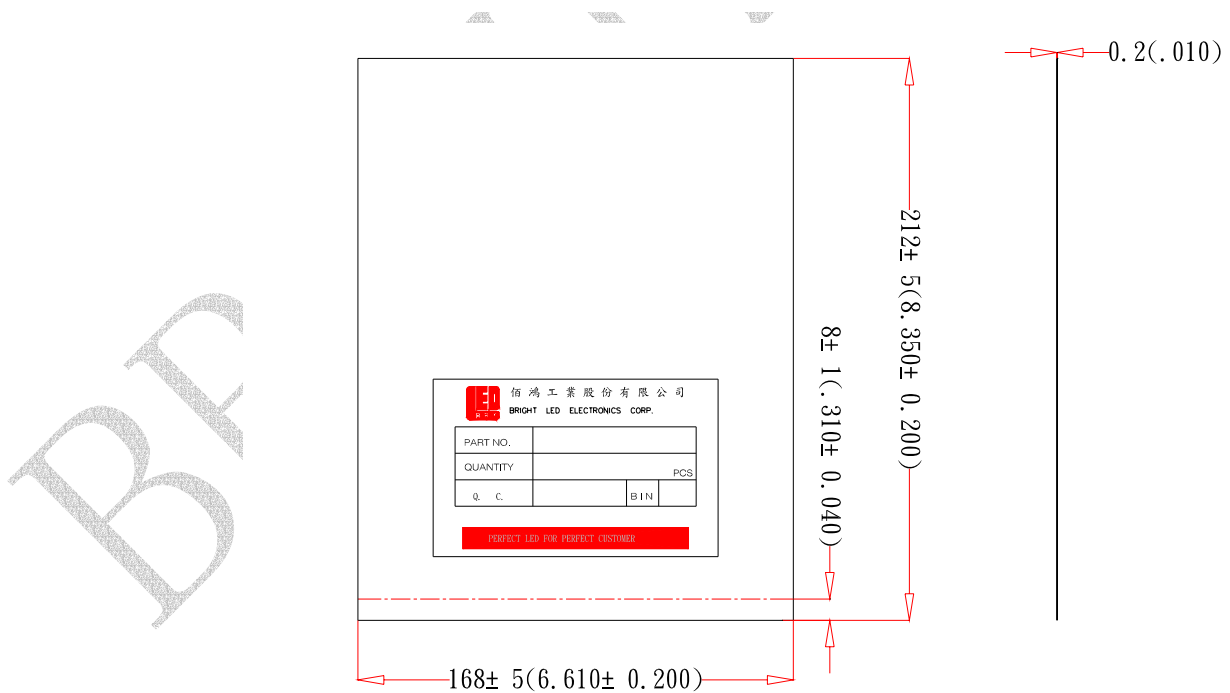

**Notes:**

- 1、1000pcs per bag, 8Kpcs per box.
- 2、All dimensions are in millimeters( inches).
- 3、Specifications are subject to change without notice.



## Infrared Emitting Diode Specification

(Commodity: Infrared emitting diode)

(Intensity Bin Limits (At 50mA))

BIN CODE	Min.(mW/sr)	Max.( mW/sr)
11	9.90	13.81
12	13.81	19.42
13	19.42	27.20
14	27.20	38.08
15	38.08	53.31

NOTES: Tolerance of measurement of Radiant Intensity

: ±15%