



Inductive sensor NBN40-L3M-A2-C3-V1

- 40 mm non-flush
- 4-wire DC
- Weld Immune
- Active surface thermostet
- 2-way LED indicator



Dimensions

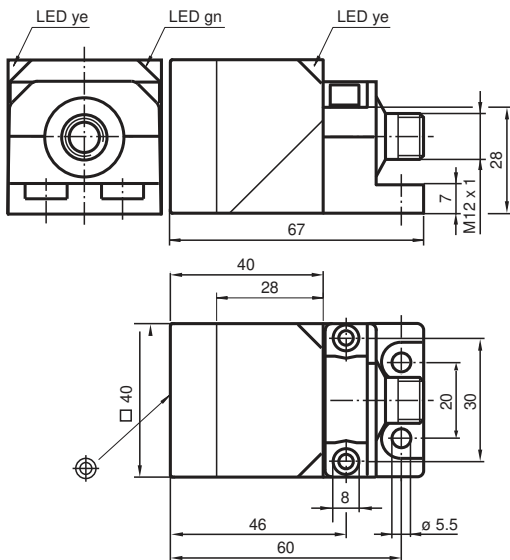

Technical Data

General specifications

Switching function		complementary
Output type		PNP
Rated operating distance	s_n	40 mm
Installation		non-flush
Output polarity		DC
Assured operating distance	s_a	0 ... 32.4 mm
Actual operating distance	s_r	36 ... 44 mm
Reduction factor r_{Al}		0.35
Reduction factor r_{Cu}		0.3
Reduction factor r_{304}		0.73
Reduction factor r_{Brass}		0.43
Output type		4-wire

Nominal ratings

Release date: 2022-05-18 Date of issue: 2022-05-18 Filename: 183739_eng.pdf

Refer to "General Notes Relating to Pepperl+Fuchs Product Information".

Pepperl+Fuchs Group
www.pepperl-fuchs.com

USA: +1 330 486 0001
fa-info@us.pepperl-fuchs.com

Germany: +49 621 776 1111
fa-info@de.pepperl-fuchs.com

Singapore: +65 6779 9091
fa-info@sg.pepperl-fuchs.com

PF PEPPERL+FUCHS

Technical Data

Operating voltage	U_B	10 ... 30 V DC
Switching frequency	f	0 ... 5 Hz
Hysteresis	H	typ. 5 %
Reverse polarity protection		reverse polarity protected
Short-circuit protection		pulsing
Voltage drop	U_d	≤ 3 V
Operating current	I_L	0 ... 200 mA
Off-state current	I_r	0 ... 0.5 mA
No-load supply current	I_0	≤ 20 mA
Time delay before availability	t_v	80 ms
Operating voltage indicator		LED, green
Switching state indicator		LED, yellow

Functional safety related parameters

MTTF _d		1190 a
Mission Time (T _M)		20 a
Diagnostic Coverage (DC)		0 %

Compliance with standards and directives

Standard conformity		
Standards		EN 60947-5-2:2007 EN 60947-5-2/A1:2012 IEC 60947-5-2:2007 IEC 60947-5-2 AMD 1:2012

Approvals and certificates

UL approval		cULus Listed, General Purpose
CCC approval		CCC approval / marking not required for products rated ≤ 36 V

Ambient conditions

Ambient temperature		-25 ... 85 °C (-13 ... 185 °F)
Storage temperature		-40 ... 85 °C (-40 ... 185 °F)

Mechanical specifications

Connection type		Connector plug M12 x 1, 4-pin
Housing material		GD-ZnAl4Cu1, Coated metal fixing flange, coated.
Sensing face		Duroplast
Degree of protection		IP67

Connection

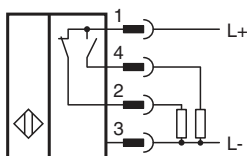

Connection Assignment

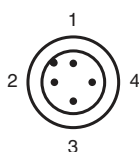





Connection Assignment

Wire colors in accordance with EN 60947-5-2

1	BN	(brown)
2	WH	(white)
3	BU	(blue)
4	BK	(black)

Accessories

	V1-W-2M-PUR	Female cordset single-ended M12 angled A-coded, 4-pin, PUR cable grey
	V1-G-2M-PUR	Female cordset single-ended M12 straight A-coded, 4-pin, PUR cable grey
	MHW 01	Modular mounting bracket
	MH 02-L	Mounting aid for VariKont-L

Release date: 2022-05-18 Date of issue: 2022-05-18 Filename: 183739_eng.pdf

Refer to "General Notes Relating to Pepperl+Fuchs Product Information".

Pepperl+Fuchs Group
www.pepperl-fuchs.com

USA: +1 330 486 0001
fa-info@us.pepperl-fuchs.com

Germany: +49 621 776 1111
fa-info@de.pepperl-fuchs.com

Singapore: +65 6779 9091
fa-info@sg.pepperl-fuchs.com