PWM STEP-UP DC/DC CONVERTER

NO.EA-075-181214

OUTLINE

The R1210Nxx1x Series are CMOS-based PWM step-up DC/DC Converter, with high accuracy, low supply current.

Each of the R1210Nxx1x Series consists of an oscillator, a PWM circuit, a reference voltage unit, an error amplifier, phase compensation circuit, resistors for voltage detection, a chip enable circuit. Further, includes a controller against drastic load transient, a control transistor with low ON-Resistance, 'Lx switch', and a protection circuit for Lx switch and an output voltage detector. R1210Nxx1A Series contain further a circuit for changeover oscillator frequency each. A low ripple, high efficiency step-up DC/DC converter can be composed of this IC with only three external components, or an inductor, a diode and a capacitor.

The R1210N Series can detect drastic change of output voltage with a circuit controller. The load transient response is improved compared with current model, furthermore the R1210Nxx1A Series have another function, that is, when the load current is small, oscillator frequency is decreased by a circuit for switching oscillator frequency from Typ. 100kHz to 35kHz, therefore, supply current is reduced.

The built-in chip enable circuit can make the standby mode with ultra low quiescent current.

Since the package for these ICs is small SOT-23-5, high density mounting of the ICs on board is possible.

FEATURES

- External Components..... Only an inductor, a diode, and a capacitor
- Standby Current Max. 0.5 μ A
- Temperature-Drift Coefficient of Output Voltage Typ. \pm 100ppm/ $^{\circ}$ C
- Output Voltage Range 2.2V to 3.5V (xx1A), 2.2V to 6.0V (xx1C/D), 0.1V steps
- Two choices of Basic Oscillator Frequency 100kHz (xx1A/C), 180kHz (xx1D)
- Output Voltage Accuracy \pm 2.5%
- Package SOT-23-5
- Efficiency Typ. 88% (V_{IN} =Set Output Voltage \times 0.6 [V], I_{OUT} =10mA)
- Low Ripple, Low Noise
- Built-in a driver transistor with low on-resistance
- Start-up Voltage Max. 0.9V
- Basic Frequency change-over circuit (only for xx1A type) from Typ. 100kHz to 35kHz

APPLICATIONS

- Power source for battery-powered equipment.
- Power source for portable communication appliances, cameras, VCRs
- Power source for appliances of which require higher voltage than battery voltage.

BLOCK DIAGRAMS

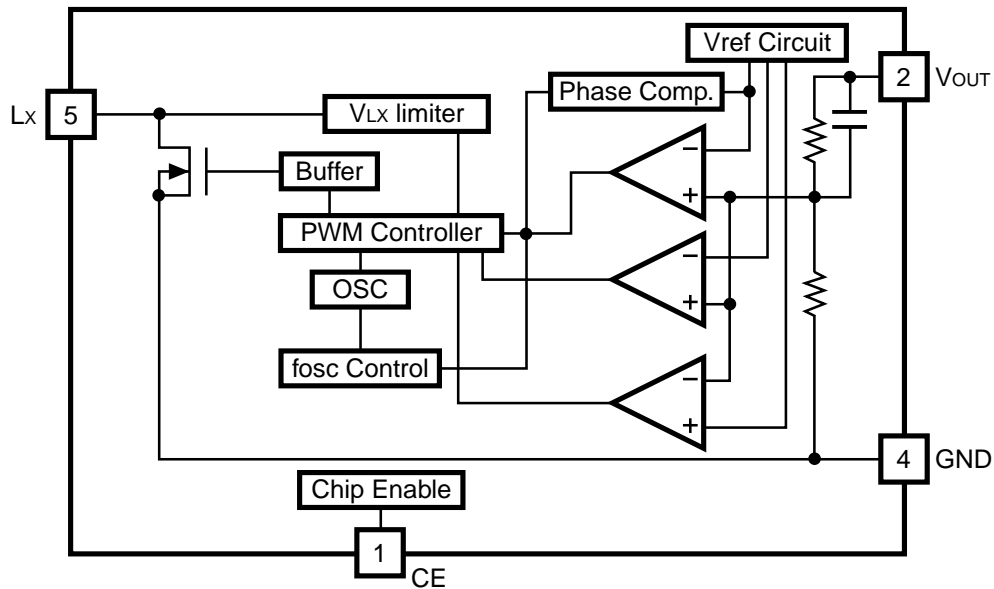

SELECTION GUIDE

Product Name	Package	Quantity per Reel	Pb Free	Halogen Free
R1210Nxx1*-TR-FE	SOT-23-5	3,000 pcs	Yes	Yes
xx : The output voltage can be designated. (0.1V steps) xx1A : 2.2V(22) to 3.5V(35) xx1C/xx1D : 2.2V(22) to 6.0V(60)				
* : The oscillator frequency and the Frequency Change-over circuit are options as follows.				
Code	Oscillator frequency	Frequency Change-over circuit		
A	100kHz	Yes		
C	100kHz	No		
D	180kHz	No		

PIN CONFIGURATIONS

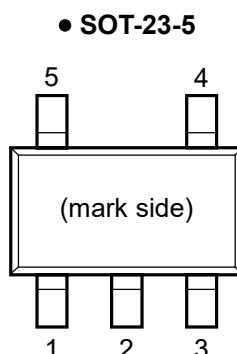

PIN DESCRIPTIONS

• SOT-23-5

Pin No	Symbol	Pin Description
1	CE	Chip Enable Pin ("H" Active)
2	V _{OUT}	Pin for Monitoring Output Voltage
3	NC	No Connection
4	GND	Ground Pin
5	L _x	Switching Pin (Nch Open Drain)

ABSOLUTE MAXIMUM RATINGS

Symbol	Item	Rating	Unit
V _{OUT}	V _{OUT} Pin Output Voltage	-0.3 to 9.0	V
V _{LX}	L _x Pin Output Voltage	-0.3 to 9.0	V
V _{CE}	CE Pin Input Voltage	-0.3 to 9.0	V
I _{LX}	L _x Pin Output Current	400	mA
P _D	Power Dissipation* (SOT-23-5)	420	mW
T _{opt}	Operating Temperature Range	-40 to 85	°C
T _{stg}	Storage Temperature Range	-55 to 125	°C

*) For Power Dissipation, please refer to PACKAGE INFORMATION.

ABSOLUTE MAXIMUM RATINGS

Electronic and mechanical stress momentarily exceeded absolute maximum ratings may cause the permanent damages and may degrade the life time and safety for both device and system using the device in the field. The functional operation at or over these absolute maximum ratings is not assured.

ELECTRICAL CHARACTERISTICS
• R1210Nxx1x

 T_{opt}=25°C

Symbol	Item	Conditions	Min.	Typ.	Max.	Unit	
V _{OUT}	Output Voltage	V _{IN} =V _{SET} ×0.6, I _{OUT} =1mA	×0.975		×1.025	V	
V _{IN}	Maximum Input Voltage				8	V	
ΔV _{OUT} /ΔT _{opt}	Step-up Output Voltage Temperature Coefficient	-40°C≤T _{opt} ≤85°C		±100		ppm/°C	
V _{start}	Start-up Voltage	V _{IN} =0V→2V, V _{OUT} :1.8kΩ pull-down			0.9	V	
ΔV _{start} /ΔT _{opt}	Start-up Voltage Temperature Coefficient	-40°C≤T _{opt} ≤85°C		-3.2		mV/°C	
V _{hold}	Hold-on Voltage	V _{IN} =2.0V→0V, I _{OUT} =1mA	xx1A/C	0.7		V	
			xx1D	0.9			
I _{DD2}	Supply Current 2	V _{OUT} =V _{CE} =V _{SET} +0.5V	xx1A/C		10	17	μA
			xx1D		15	24	μA
I _{standby}	Standby Current	V _{OUT} =6.5V, V _{CE} =0V			0.5	μA	
I _{LXleak}	L _X Leakage Current	V _{OUT} =V _{LX} =8V			0.5	μA	
f _{osc}	Maximum Oscillator Frequency	V _{OUT} =V _{CE} =V _{SET} ×0.96	xx1A/C	80	100	120	kHz
			xx1D	144	180	216	kHz
Δ f _{osc} /ΔT _{opt}	Oscillator Frequency Temperature Coefficient	-40°C≤T _{opt} ≤85°C	xx1A/C		0.5		kHz/°C
			xx1D		0.6		kHz/°C
Maxduty	Oscillator Maximum Duty Cycle	V _{OUT} =V _{CE} =V _{SET} ×0.96, (V _{LX} "L" Side)	70	85	97	%	
V _{LXlim}	V _{LX} Limit Voltage	V _{OUT} =V _{CE} =V _{SET} ×0.96, (V _{LX} "L" Side)	0.4	0.6	0.8	V	
V _{CEH}	CE "H" Input Voltage	V _{OUT} =V _{SET} ×0.96	0.9			V	
V _{CEL}	CE "L" Input Voltage	V _{OUT} =V _{SET} ×0.96			0.3	V	
I _{CEH}	CE "H" Input Current	V _{OUT} =V _{CE} =6.5V	-0.1	0	0.1	μA	
I _{CEL}	CE "L" Input Current	V _{IN} =6.5V, V _{CE} =0V	-0.1	0	0.1	μA	
f _{osc2}	Change-over frequency	V _{IN} =V _{SET} ×0.6, I _{OUT} =0.5mA (only for xx1A)	10	35	70	kHz	
I _{DD1}	Supply Current 1 (xx1A/C)	V _{OUT} = V _{SET} ×0.96	2.2V≤V _{SET} ≤2.5V		30	55	μA
			2.6V≤V _{SET} ≤3.0V		35	60	
			3.1V≤V _{SET} ≤3.5V		40	70	
			3.6V≤V _{SET} ≤4.0V		45	80	
			4.1V≤V _{SET} ≤4.5V		50	90	
			4.6V≤V _{SET} ≤5.0V		70	100	
			5.1V≤V _{SET} ≤5.5V		80	110	
			5.6V≤V _{SET} ≤6.0V		90	120	

Symbol	Item	Conditions	Min.	Typ.	Max.	Unit	
I _{DD1}	Supply Current 1 (xx1D)	V _{OUT} =V _{SET} ×0.96	2.2V≤V _{SET} ≤2.5V		50	80	μA
			2.6V≤V _{SET} ≤3.0V		60	90	
			3.1V≤V _{SET} ≤3.5V		70	100	
			3.6V≤V _{SET} ≤4.0V		80	110	
			4.1V≤V _{SET} ≤4.5V		90	120	
			4.6V≤V _{SET} ≤5.0V		100	130	
			5.1V≤V _{SET} ≤5.5V		110	150	
			5.6V≤V _{SET} ≤6.0V		120	170	
I _{LX}	L _X Switching Current	V _{LX} =0.4V	2.2V≤V _{SET} ≤2.4V	70			mA
			2.5V≤V _{SET} ≤2.9V	85			
			3.0V≤V _{SET} ≤3.4V	100			
			3.5V≤V _{SET} ≤3.9V	120			
			4.0V≤V _{SET} ≤4.4V	140			
			4.5V≤V _{SET} ≤4.9V	150			
			5.0V≤V _{SET} ≤5.4V	170			
			5.5V≤V _{SET} ≤6.0V	190			

*Note: V_{SET} means setting Output Voltage.

RECOMMENDED OPERATING CONDITIONS (ELECTRICAL CHARACTERISTICS)

All of electronic equipment should be designed that the mounted semiconductor devices operate within the recommended operating conditions. The semiconductor devices cannot operate normally over the recommended operating conditions, even if when they are used over such conditions by momentary electronic noise or surge. And the semiconductor devices may receive serious damage when they continue to operate over the recommended operating conditions.

TYPICAL APPLICATIONS AND TECHNICAL NOTES

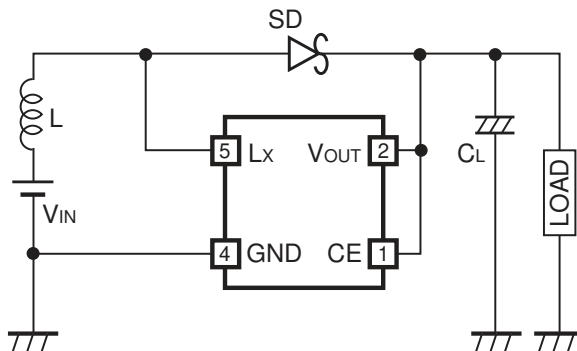

L : 100 μ H CD54NP (Sumida Electric Co, LTD)

SD : CRS10I30A (TOSHIBA, Schottky Type)

CL : 22 μ F \times 2 (Tantalum Type)

When you use these ICs, consider the following issues;

- Set external components as close as possible to the IC and minimize the connection between the components and the IC. In particular, a capacitor should be connected to V_{OUT} pin with the minimum connection.

- Make sufficient grounding. A large current flows through GND pin by switching. When the impedance of the GND connection is high, the potential within the IC is varied by the switching current. This may result in unstable operation of the IC.

- Use capacitors with a capacity of 22 μ F or more, and with good high frequency characteristics such as tantalum capacitors.

We recommend you to use output capacitors with an allowable voltage at least 3 times as much as setting output voltage. This is because there may be a case where a spike-shaped high voltage is generated by an inductor when an Lx transistor is off.

- Choose an inductor that has sufficiently small D.C. resistance and large allowable current and is hard to reach magnetic saturation.

And if the value of inductance of an inductor is extremely small, the I_{LX} may exceed the absolute maximum rating at the maximum loading.

Use an inductor with appropriate inductance.

- Use a diode of a Schottky type with high switching speed, and also pay attention to its current capacity.

*The performance of power circuit with using this IC depends on external components. Choose the most suitable components for your application.

TYPICAL CHARACTERISTICS

1) Output Voltage vs. Output Current

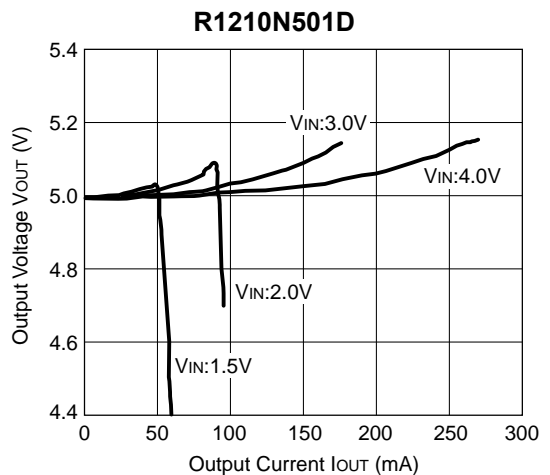
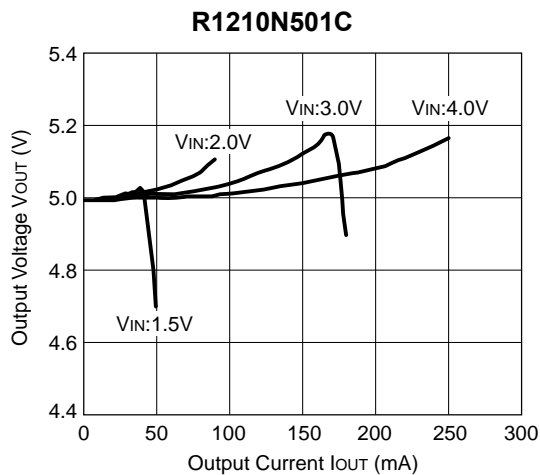
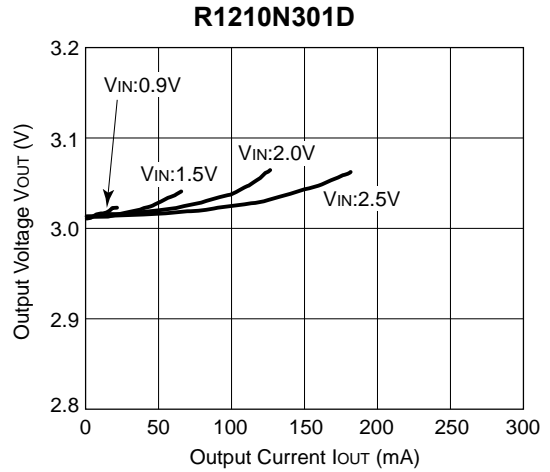
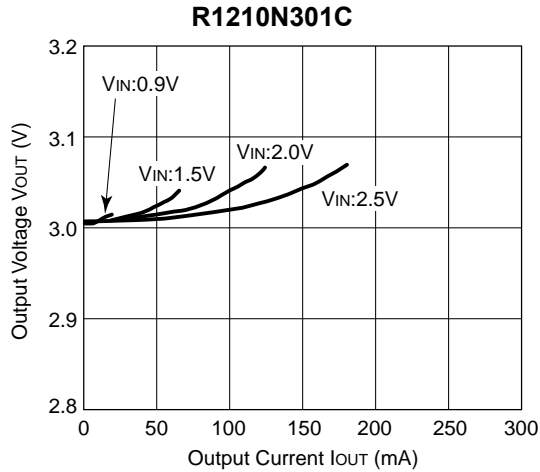

2) Efficiency vs. Output Current

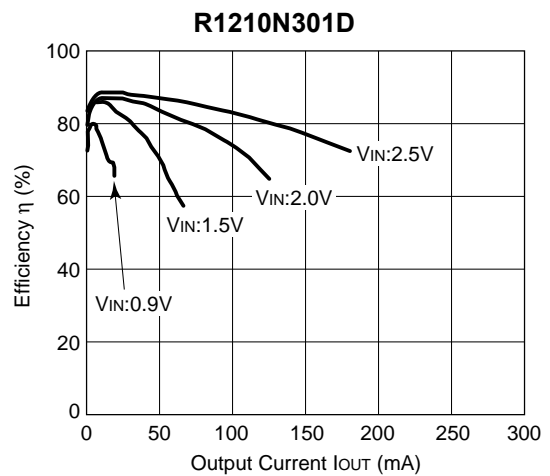
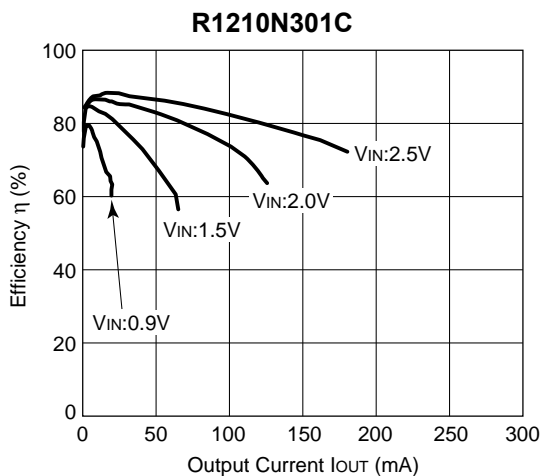

R1210Nxx1x

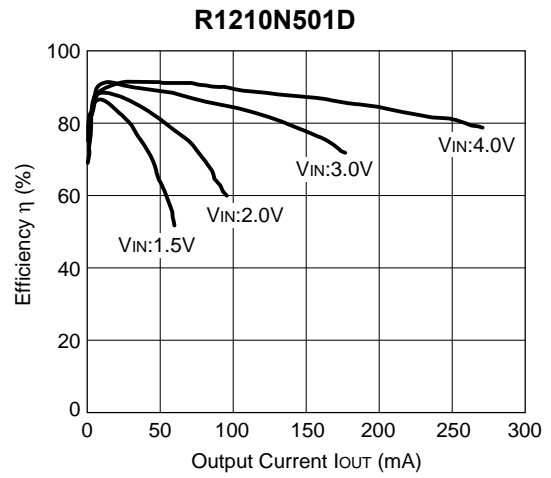
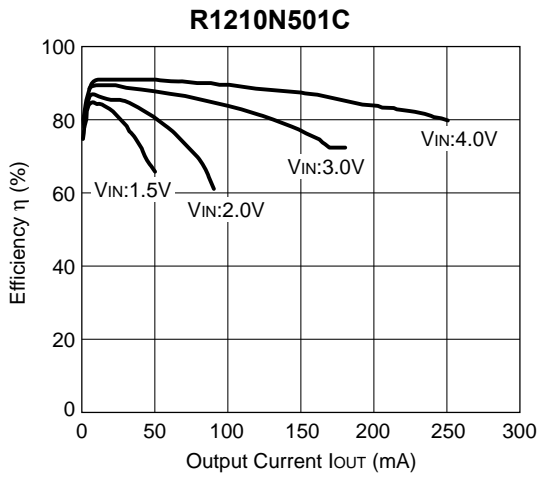

3) R1210Nxx1A/C Efficiency

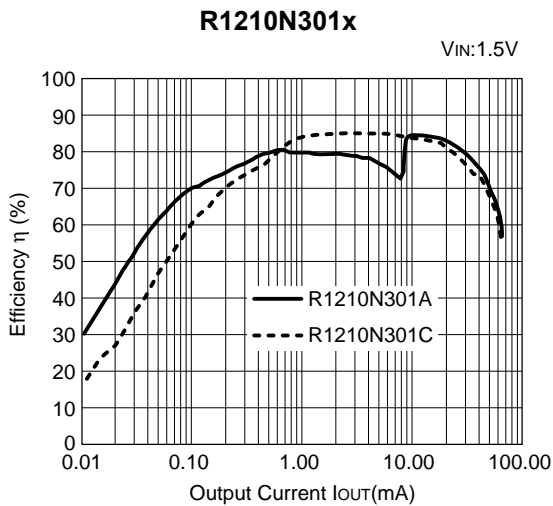

4) Ripple Voltage vs. Output Current

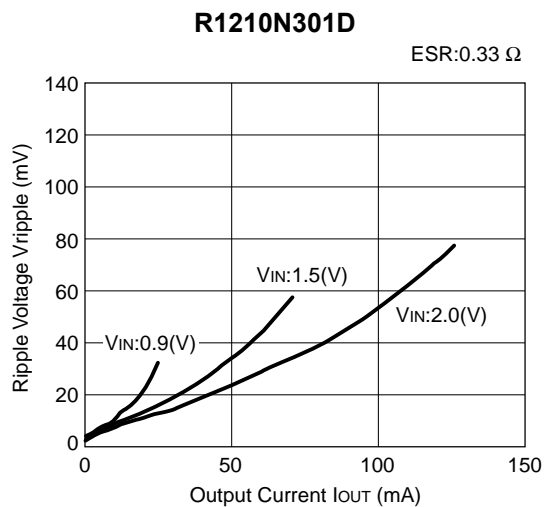
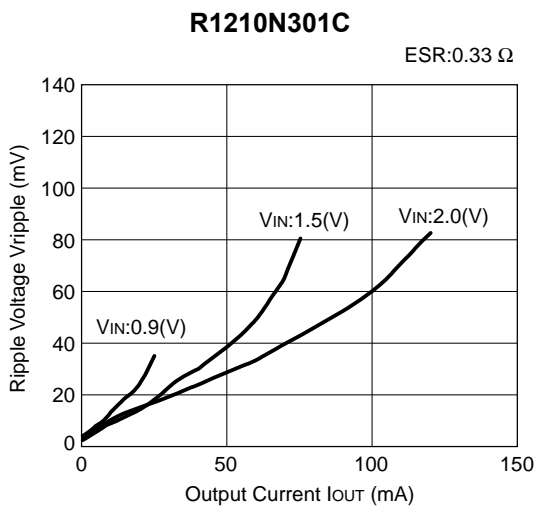

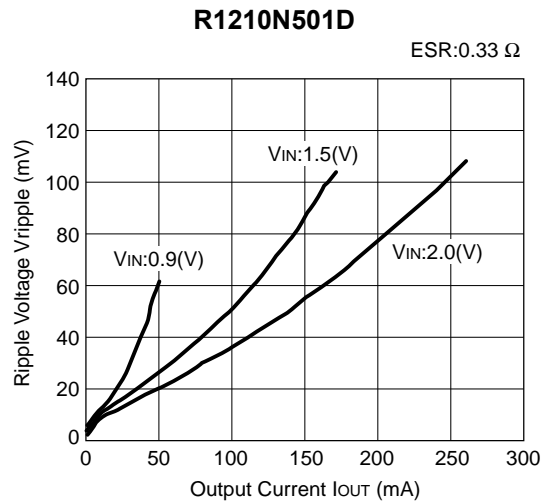
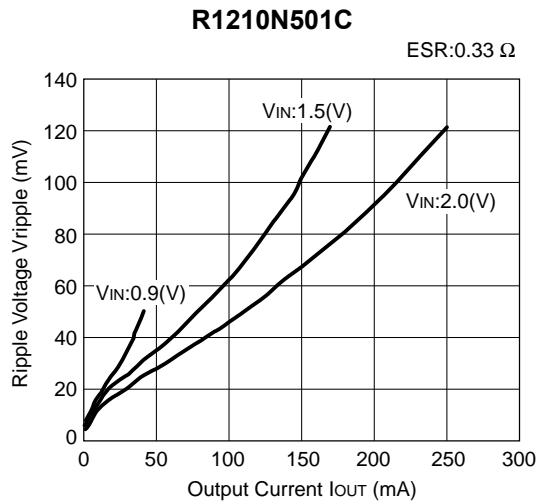

5) Start-up Voltage/Hold-on Voltage vs. Output Current (Topt=25°C)

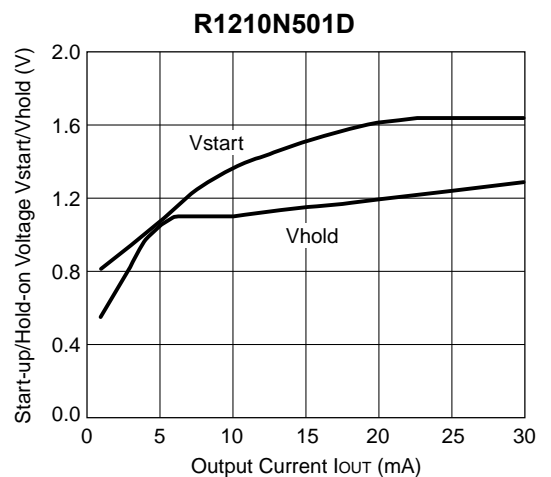
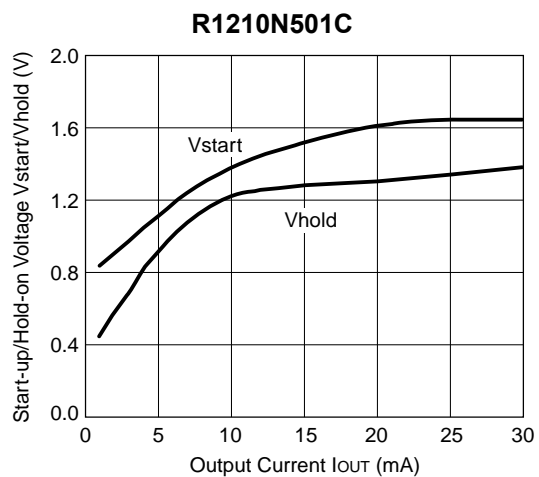
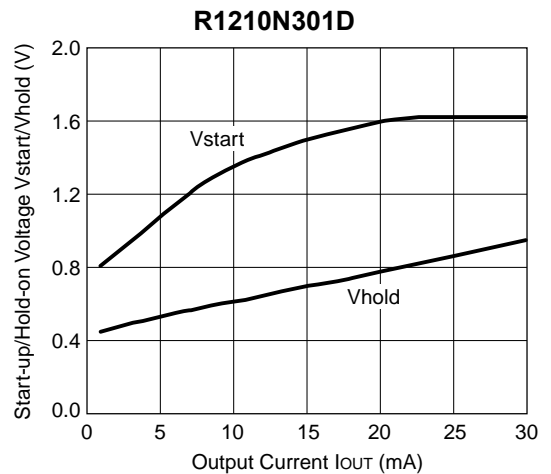
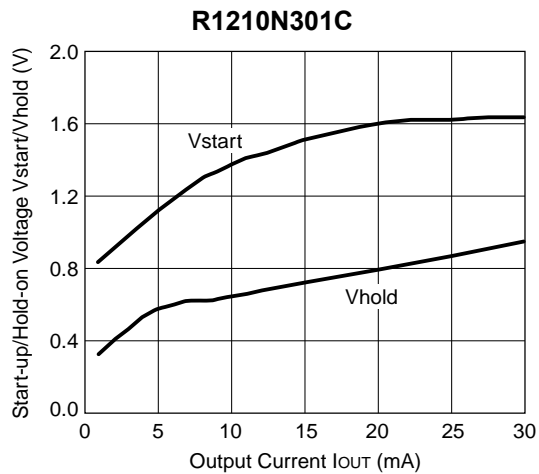

6) Output Voltage vs. Temperature

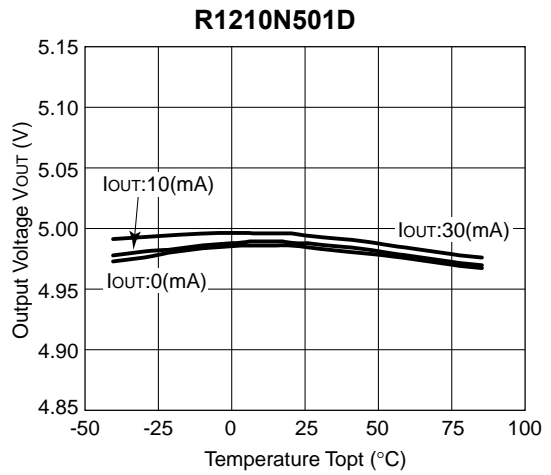
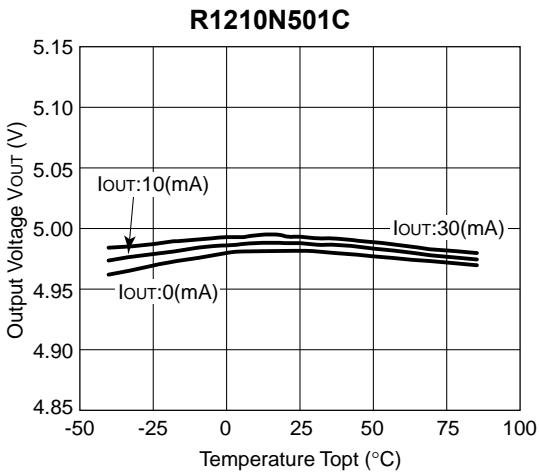
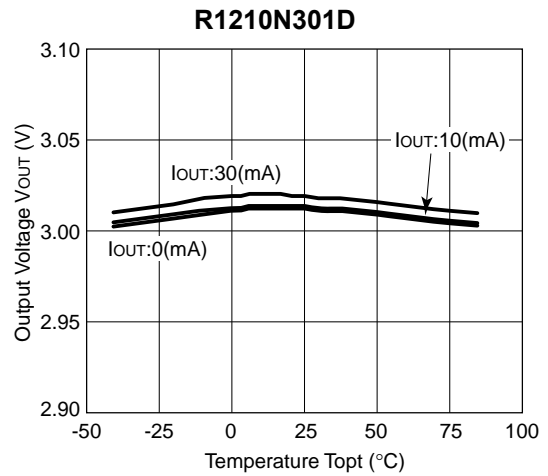
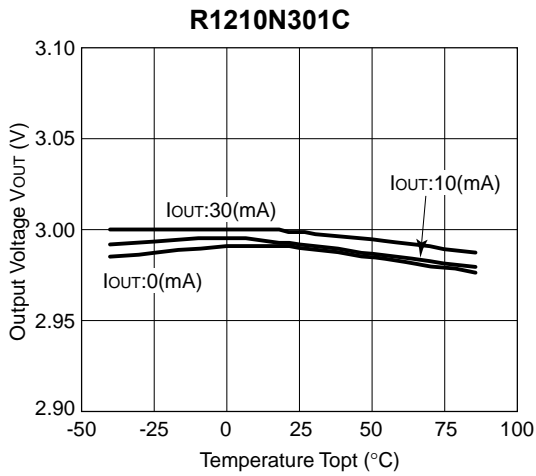

7) Supply Current 1 vs. Temperature

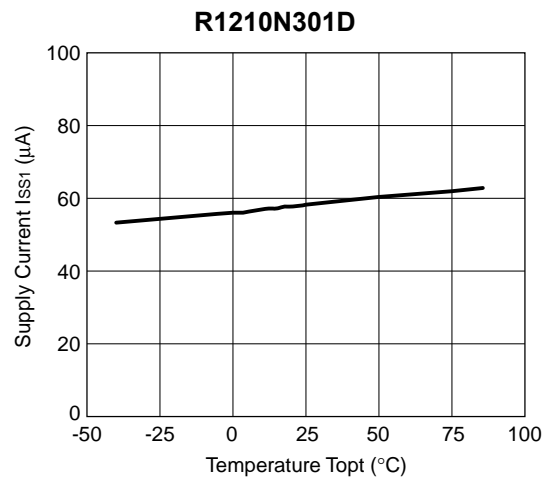
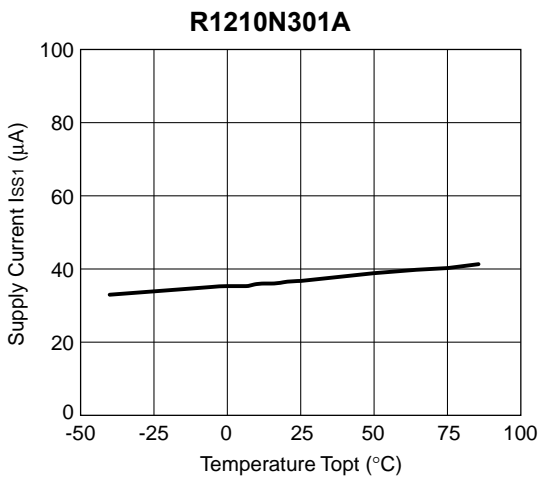

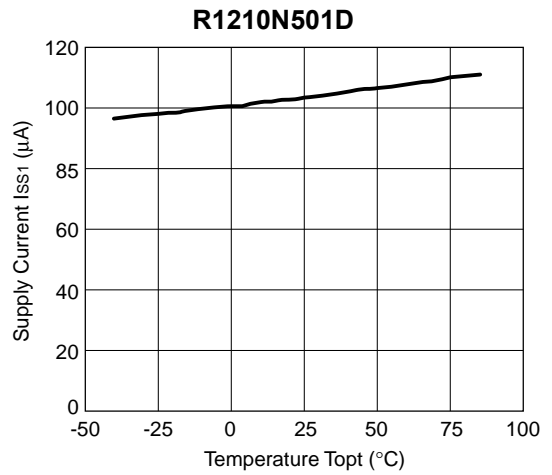
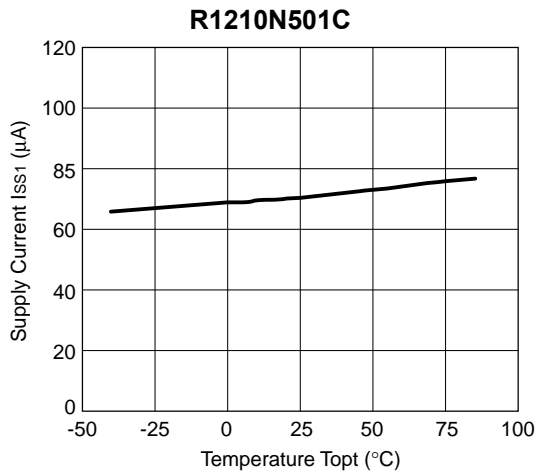

8) Supply Current2 vs. Temperature

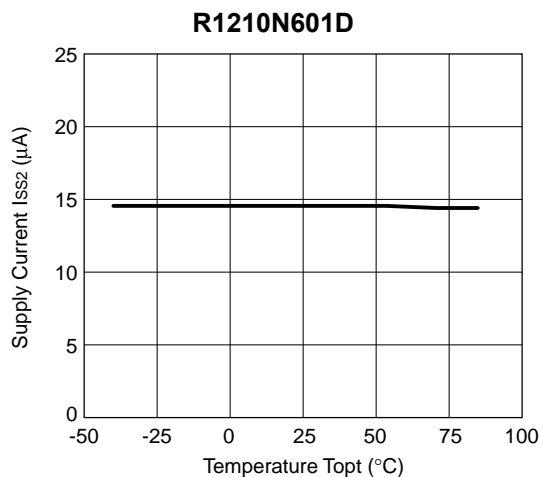
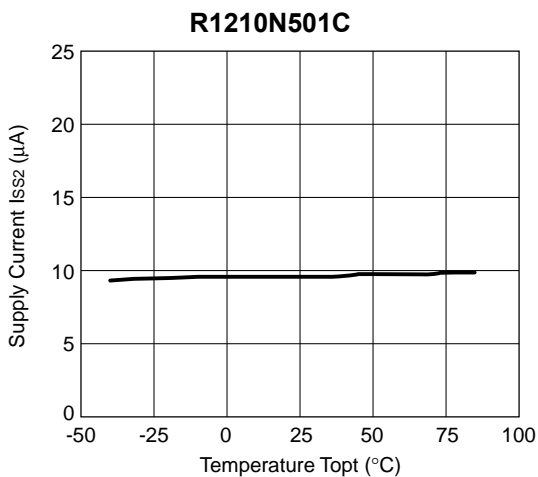
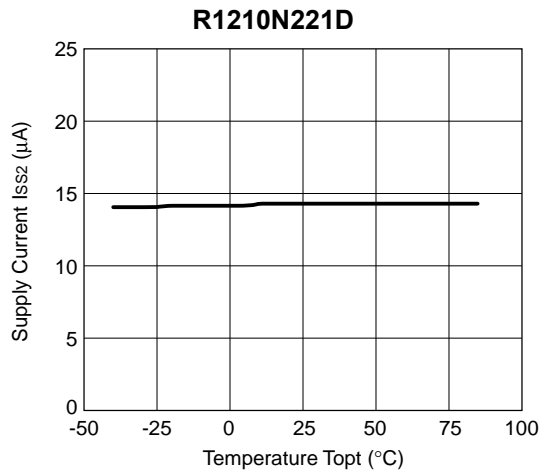
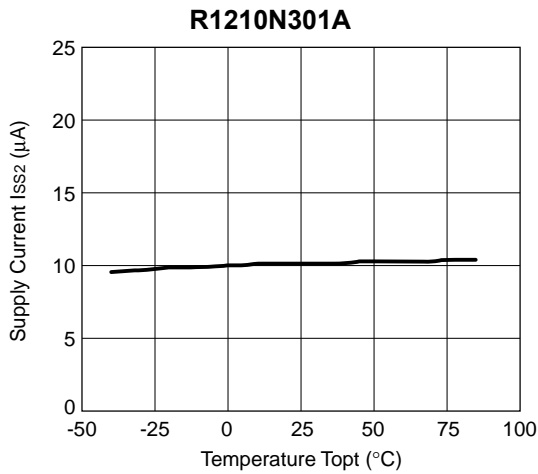

9) Standby Current vs. Temperature

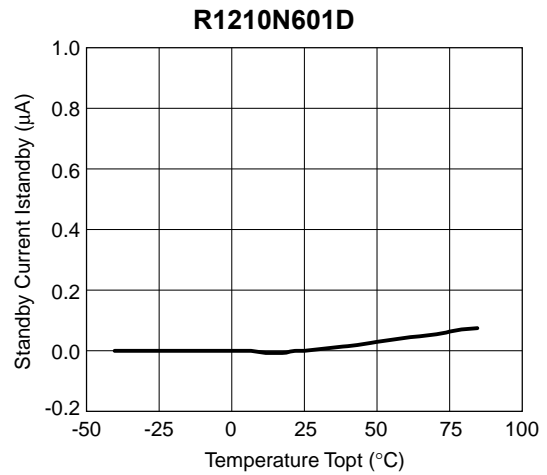
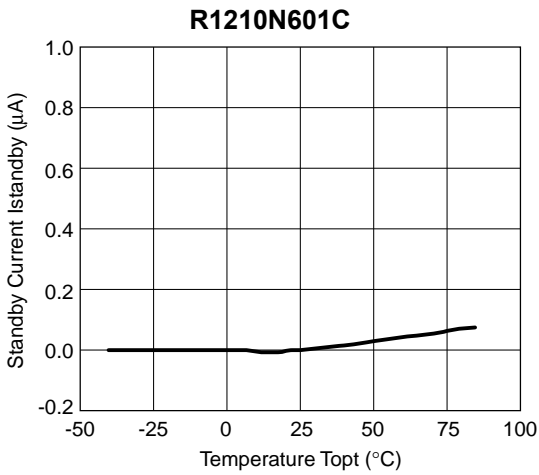
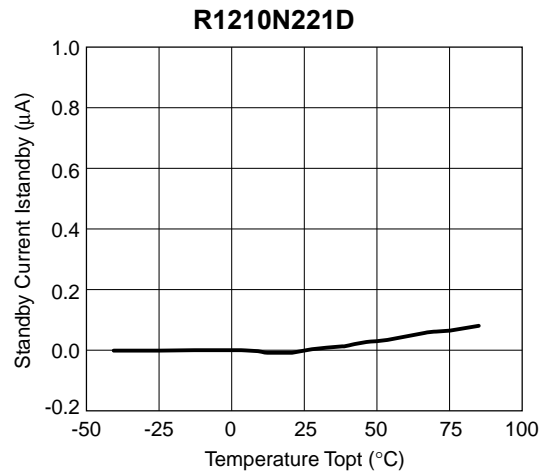
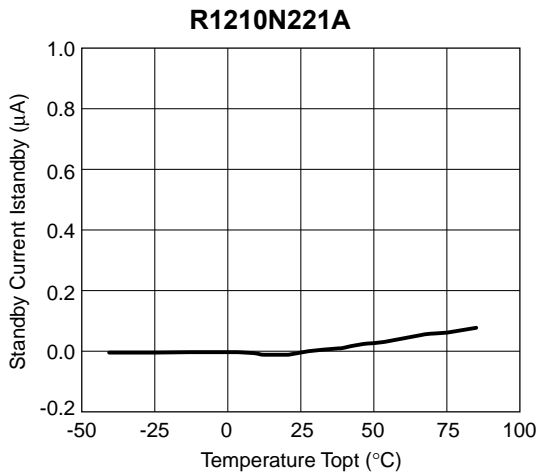

10) Oscillator Frequency vs. Temperature

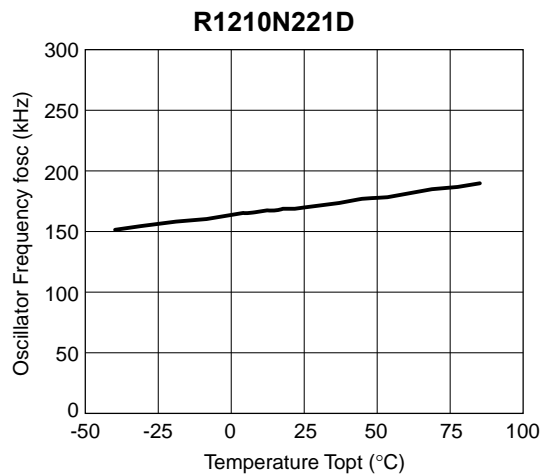
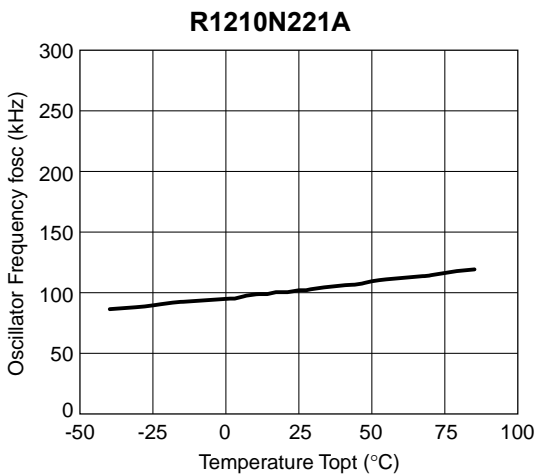

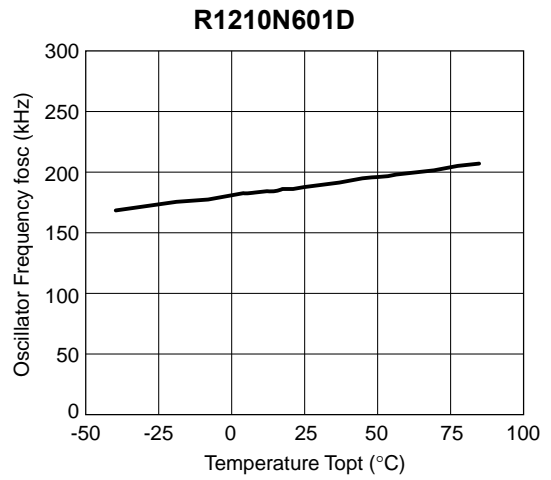
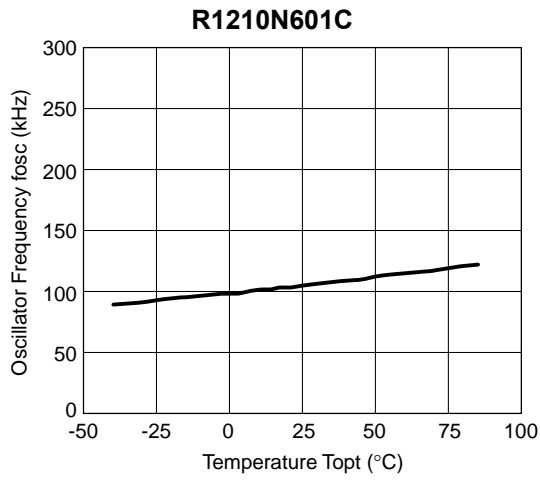

11) Maximum Duty Cycle vs. Temperature

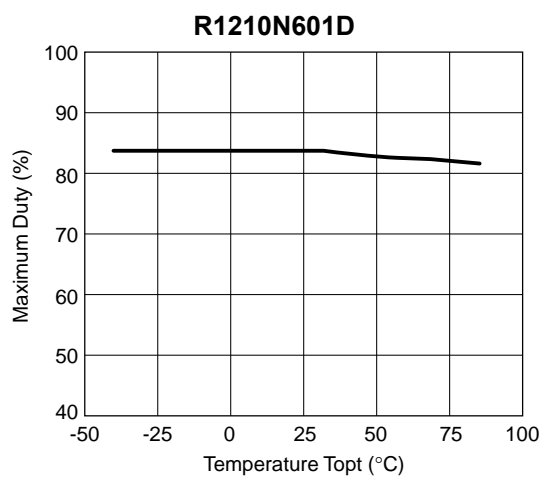
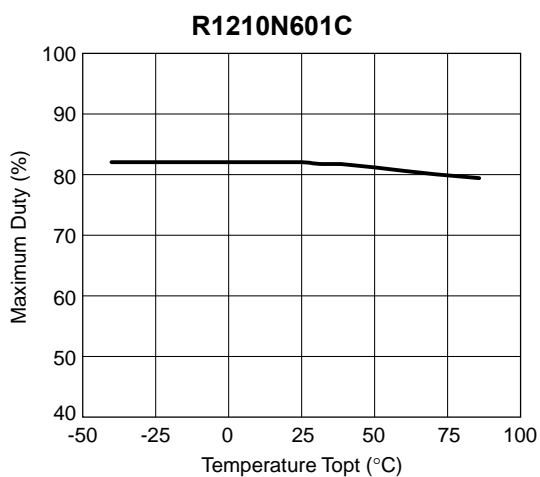
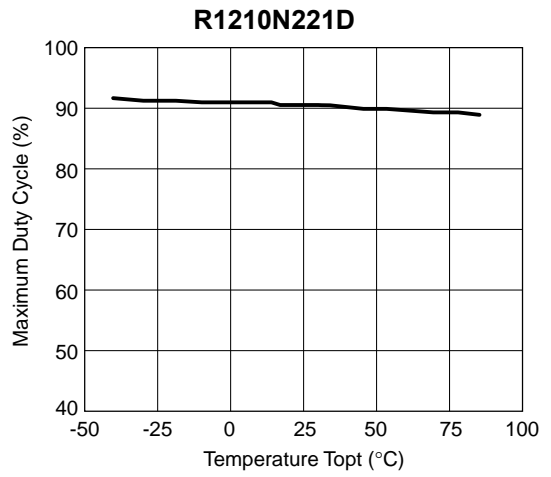
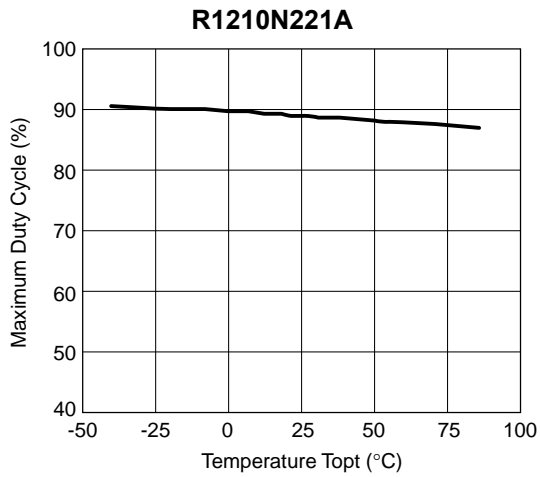

12) Lx Switching Current vs. Temperature

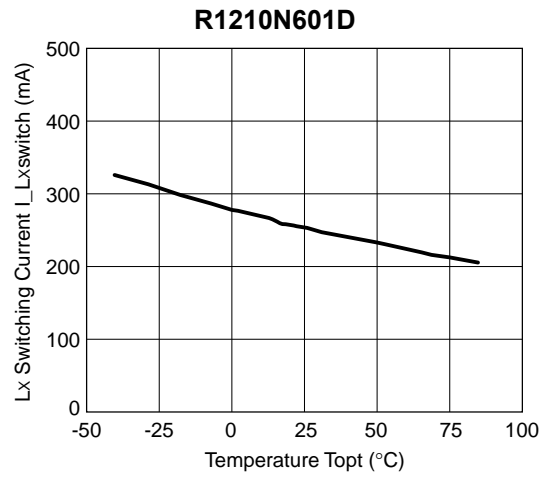
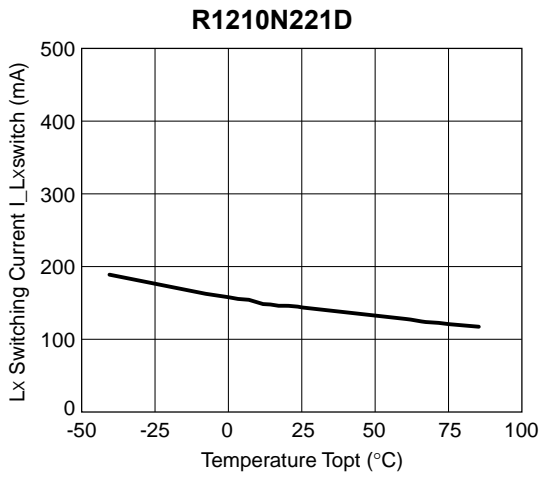
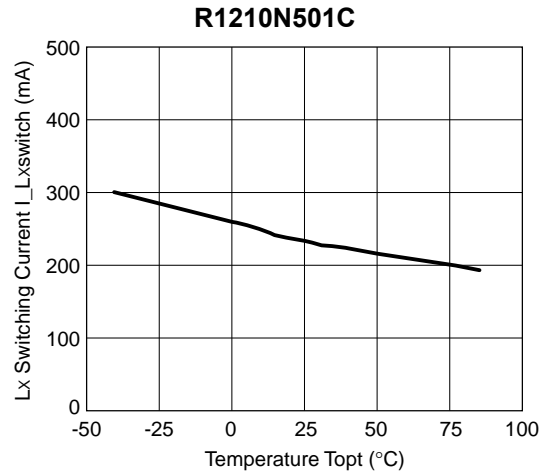
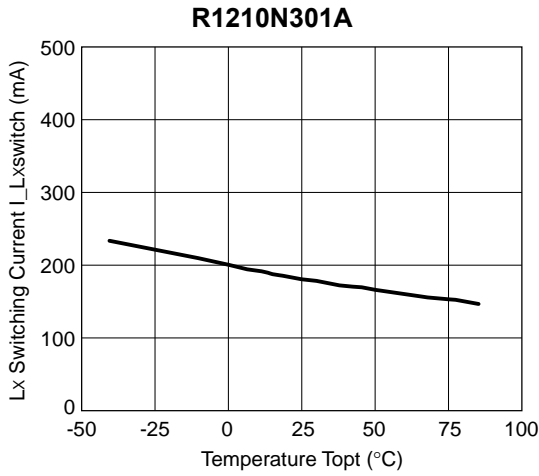

13) Lx leakage Current vs. Temperature

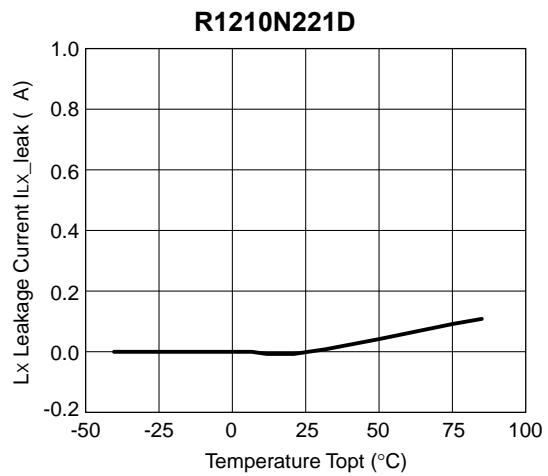
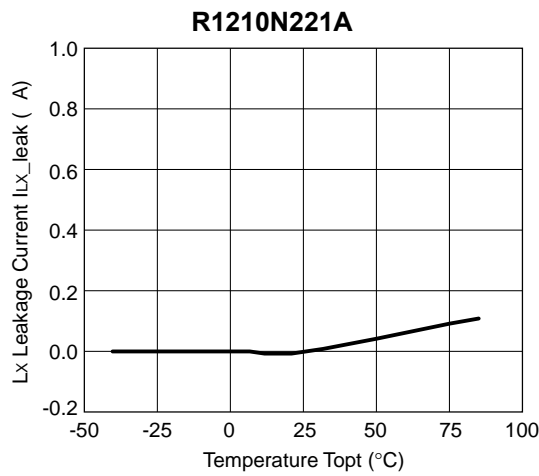

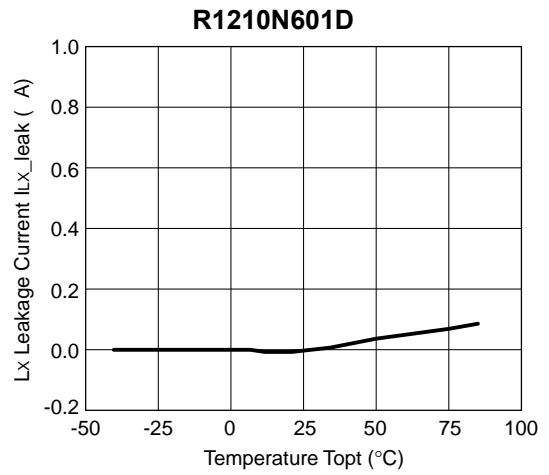
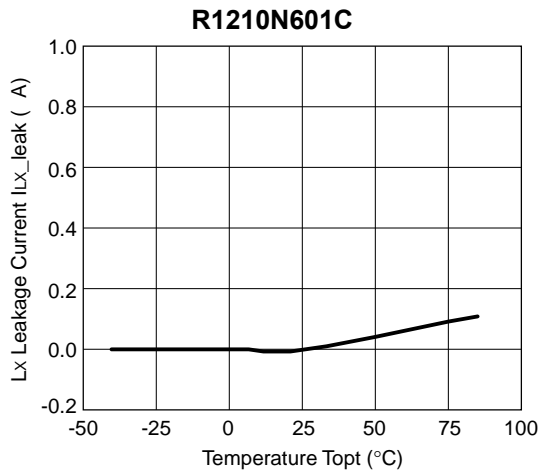

14) V_{Lx} Voltage Limit vs. Temperature

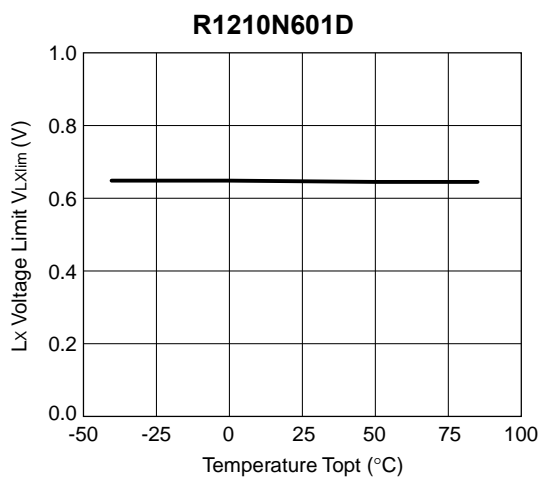
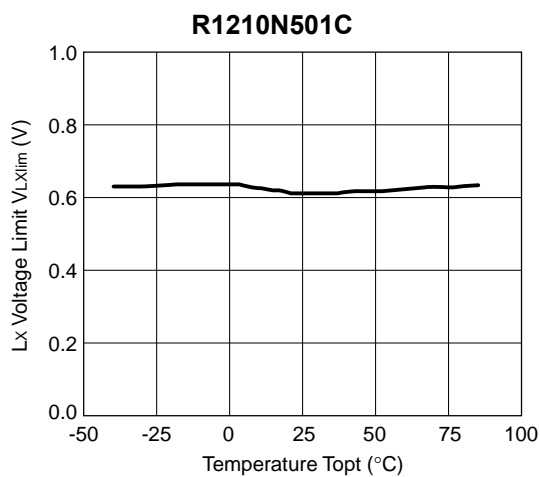
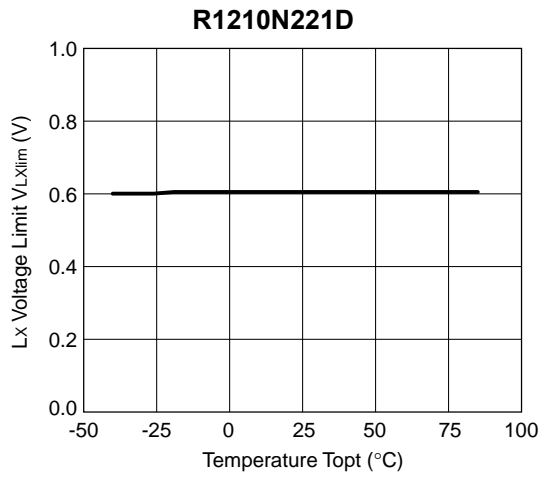
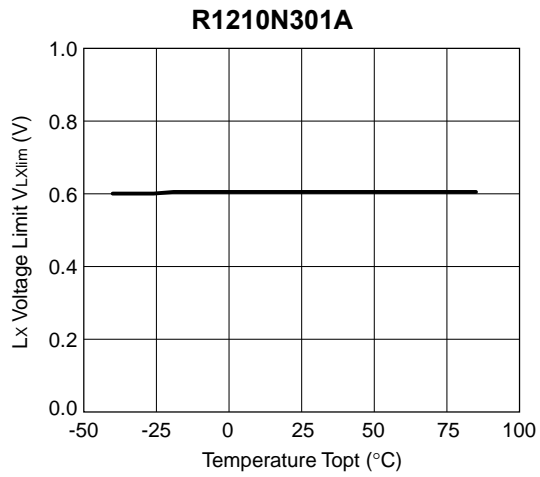

15) CE "H" Input Voltage vs. Temperature

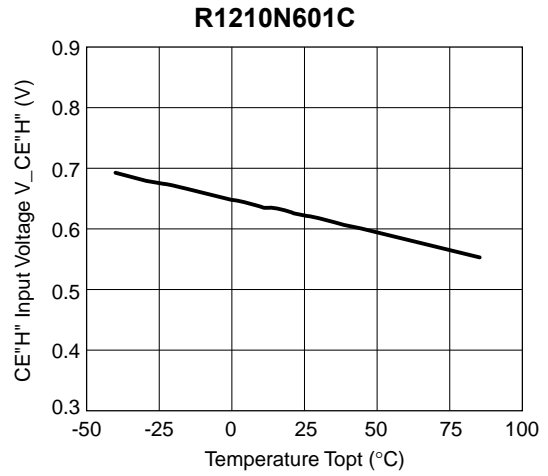
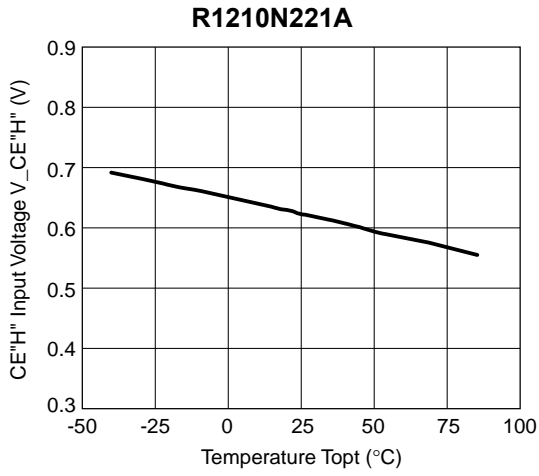

16) CE "L" Input Voltage vs. Temperature

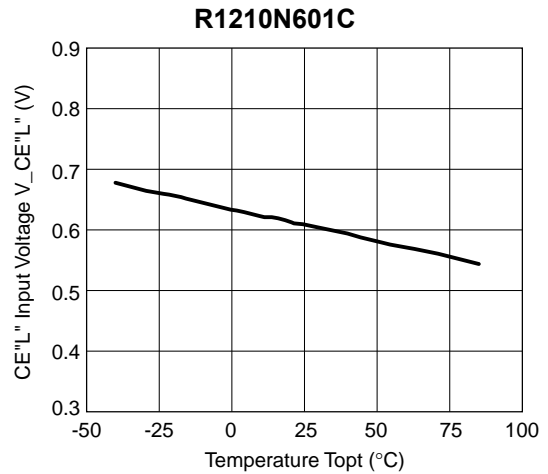
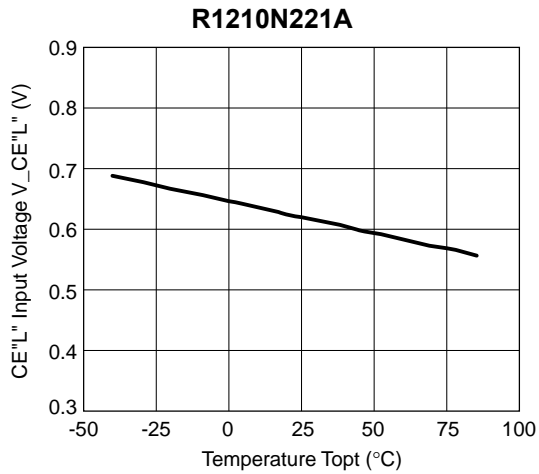



1. The products and the product specifications described in this document are subject to change or discontinuation of production without notice for reasons such as improvement. Therefore, before deciding to use the products, please refer to our sales representatives for the latest information thereon.
2. The materials in this document may not be copied or otherwise reproduced in whole or in part without prior written consent of our company.
3. Please be sure to take any necessary formalities under relevant laws or regulations before exporting or otherwise taking out of your country the products or the technical information described herein.
4. The technical information described in this document shows typical characteristics of and example application circuits for the products. The release of such information is not to be construed as a warranty of or a grant of license under our company's or any third party's intellectual property rights or any other rights.
5. The products listed in this document are intended and designed for use as general electronic components in standard applications (office equipment, telecommunication equipment, measuring instruments, consumer electronic products, amusement equipment etc.). Those customers intending to use a product in an application requiring extreme quality and reliability, for example, in a highly specific application where the failure or misoperation of the product could result in human injury or death (aircraft, spacevehicle, nuclear reactor control system, traffic control system, automotive and transportation equipment, combustion equipment, safety devices, life support system etc.) should first contact us.
6. We are making our continuous effort to improve the quality and reliability of our products, but semiconductor products are likely to fail with certain probability. In order to prevent any injury to persons or damages to property resulting from such failure, customers should be careful enough to incorporate safety measures in their design, such as redundancy feature, fire containment feature and fail-safe feature. We do not assume any liability or responsibility for any loss or damage arising from misuse or inappropriate use of the products.
7. Anti-radiation design is not implemented in the products described in this document.
8. The X-ray exposure can influence functions and characteristics of the products. Confirm the product functions and characteristics in the evaluation stage.
9. WLCSP products should be used in light shielded environments. The light exposure can influence functions and characteristics of the products under operation or storage.
10. There can be variation in the marking when different AOI (Automated Optical Inspection) equipment is used. In the case of recognizing the marking characteristic with AOI, please contact our sales or our distributor before attempting to use AOI.
11. Please contact our sales representatives should you have any questions or comments concerning the products or the technical information.



Nisshinbo Micro Devices Inc.

Official website

<https://www.nisshinbo-microdevices.co.jp/en/>

Purchase information

<https://www.nisshinbo-microdevices.co.jp/en/buy/>

