

High Power LED Series 3535 Ceramic Hot Binning

LH351D

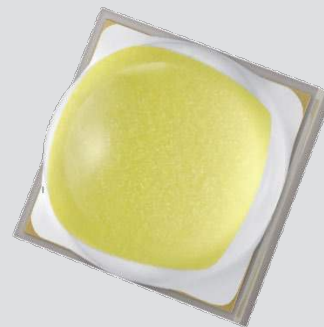

High efficacy and high quality color rendering makes the LH351D suitable use in a broad range of applications

Features & Benefits

- Operates at a maximum current of up to 3.0 A
- Uniform light distribution under any beam angle
- 90 CRI makes it well suited for most applications
- Hot binning @ 85 °C

Applications

- Indoor Lighting: Spotlight, Downlight
- Outdoor Lighting: Street Light, Tunnel Light, Security Light, Area Light, Stadium/Arena Light
- Industrial Lighting: High Bay Light, Low Bay Light
- Consumer Lighting: Torch Light



Table of Contents

1.	Characteristics	-----	3
2.	Product Code Information	-----	6
3.	Typical Characteristics Graphs	-----	15
4.	Outline Drawing & Dimension	-----	15
5.	Reliability Test Items & Conditions	-----	16
6.	Soldering Conditions	-----	19
7.	Tape & Reel	-----	20
8.	Label Structure	-----	22
9.	Packing Structure	-----	23
10.	Precautions in Handling & Use	-----	25

1. Characteristics

a) Absolute Maximum Rating

Item	Symbol	Rating	Unit	Condition
Operating Temperature	T_{opr}	-40 ~ +105	°C	Note 1)*
Storage Temperature	T_{stg}	-40 ~ +120	°C	-
LED Junction Temperature	T_j	150	°C	Note 1)*
Forward Current	I_F	3000	mA	-
Peak Pulse Forward Current	I_{FP}	5000	mA	Duty 1/10 pulse width 10ms
Assembly Process Temperature		260 <10	°C s	-
ESD (HBM)	-	±8	kV	-

Notes:

- 1) Refer to the derating curve, '3. Typical Characteristics Graph', for proper driving current that maintained below maximum junction temperature.

b) Electro-optical Characteristics

Item	Unit	Condition			Value	
		I _F (mA)	T _J (°C)	Min	Typ	Max
Forward Voltage	V	1050	85	2.6		3.2
Reverse Voltage (@ 5 mA)	V		25	14		19.5
Thermal Resistance (junction to solder point)	°C/W		25		2.2	
Beam Angle	°	1050	25		128	

Notes:

- 1) Samsung maintains measurement tolerance of: luminous flux = $\pm 7\%$, forward voltage = ± 0.1 V
- 2) Characteristics @ 25 °C are for reference only

c) Luminous Flux Characteristics (T_j = 85 °C)

Sorting @ 1050 mA (lm)			Calculated Minimum Flux ²⁾ (lm)					
Flux Rank	Flux Range ¹⁾	Sub Rank	@ 350 mA	@ 700 mA	@ 1050 mA	@ 1500 mA	@ 2000 mA	@ 3000 mA
K6	260 ~ 320	K2, M2, N2	96	182	260	351	440	584
M6	280 ~ 340	M2, N2, P2	103	196	280	378	474	629
N6	300 ~ 360	N2, P2, Q2	111	210	300	405	507	674
P6	320 ~ 380	P2, Q2, R2	118	224	320	432	541	719
Q6	340 ~ 400	Q2, R2, S2	126	238	340	459	575	764
R6	360 ~ 420	R2, S2, T2	133	252	360	486	609	809
S6	380 ~ 440	S2, T2, U2	140	266	380	513	643	854
T6	400 ~ 460	T2, U2, V2	148	280	400	540	677	899
U6	420 ~ 480	U2, V2, W2	155	294	420	567	710	944
V6	440 ~ 500	V2, W2, Y2	163	308	440	593	744	989
W6	460 ~ 520	W2, Y2, Z2	170	322	460	620	778	1,034
Y6	480 ~ 540	Y2, Z2, 12	177	336	480	647	812	1,079
Z6	500 ~ 560	Z2, 12, 22	185	350	500	674	846	1,123
16	520 ~ 580	12, 22, 32	192	364	520	701	879	1,168
26	540 ~ 600	22, 32, 42	200	378	540	728	913	1,213
36	560 ~ 620	32, 42, 52	207	392	560	755	947	1,258
46	580 ~ 640	42, 52, 62	214	406	580	782	981	1,303
56	600 ~ 660	52, 62, 72	222	420	600	809	1,015	1,348
66	620 ~ 680	62, 72, 82	229	434	620	836	1,049	1,393
76	640 ~ 700	72, 82, 92	237	448	640	863	1,082	1,438
86	660 ~ 720	82, 92 ~	244	462	660	890	1,116	1,483
96	680 ~ 740	92 ~	251	476	680	917	1,150	1,528

Notes:

- 1) Samsung maintains measurement tolerance of: luminous flux = ±7 %, CRI = ±3
- 2) Calculated minimum flux values are for reference only

2. Product Code Information

1	2	3	4	5	6	7	8	9	10	11	12	13	14	15	16	17	18
S	P	H	W	H	T	L	3	D	A	0	C	F	4	R	T	U	6

Digit	PKG Information	Code	Specification
1 2 3	Samsung Package High Power	SPH	
4 5	Color	WH	White
6	Product Version	T	
7 8	Product	L3	LH351 Series
9	Lens Type	D	Dome lens
10	Internal Code	A	LH351D
11	Not Defined	0	Default
12	CRI & Sorting Temperature	C E G	Min. 70 Min. 80 85 °C Min. 90
13 14	Forward Voltage (V)	F 4	2.6~3.2 Bin Code: D2 2.6~2.8 F2 2.8~3.0 H2 3.0~3.2
15 16	CCT (K)	W★ V★ U★ T★ R◇ Q R Q◇ P Q P◇	2700 W1, W2, W3, W4, W5, W6, W7, W8, W9, WA, WB, WC, WD, WE, WF, WG, WM 3000 V1, V2, V3, V4, V5, V6, V7, V8, V9, VA, VB, VC, VD, VE, VF, VG, VM 3500 U1, U2, U3, U4, U5, U6, U7, U8, U9, UA, UB, UC, UD, UE, UF, UG, UM 4000 T1, T2, T3, T4, T5, T6, T7, T8, T9, TA, TB, TC, TD, TE, TF, TG, TM 5000 Bin Code: R1, R2, R3, R4, RN 5300 Q2, Q4, R1, R3 5700 Q1, Q2, Q3, Q4, QN 6000 P2, P4, Q1, Q3 6500 P1, P2, P3, P4, PN ★ : "0" (Whole bin), "P" (Quarter bin), or "M" (MacAdam 3-step ellipse bin) ◇ : "T" (Half bin), "N" (MacAdam 5-step ellipse bin)
17 18	Luminous Flux (lm)	K 6 M 6 N 6 P 6 Q 6 R 6 S 6 T 6 U 6 V 6 W 6 Y 6 Z 6	260~320 K2 260~280 280~340 M2 280~ 300 300~360 N2 300~320 320~380 P2 320~340 340~400 Q2 340~360 360~420 R2 360~380 380~440 S2 380~400 400~460 T2 400~420 420~480 U2 420~440 440~500 V2 440~460 460~520 W2 460~480 480~540 Y2 480~500 500~560 Z2 500~520 12 520~540 22 540~560
			Digit 17: Min. spec. Digit 18: The number of higher bin(s) from min. spec. e.g.: K2 = 260~280 lm, K6 = 260~320 lm

a) Luminous Flux Bins ($I_f = 1050 \text{ mA}$, $T_j = 85 \text{ }^\circ\text{C}$)

CRI/ Nominal CCT (K)	Flux rank											
	P2	Q2	R2	S2	T2	U2	V2	W2	Y2	Z2	12	22
(min. flux)	320	340	360	380	400	420	440	460	480	500	520	540
70	2700						SPHWHTL3DA0CF4W ☆U6					
							SPHWHTL3DA0CF4W ☆V6					
	3000							SPHWHTL3DA0CF4V ☆W6				
									SPHWHTL3DA0CF4V ☆Y6			
	3500							SPHWHTL3DA0CF4U ☆W6				
	4000								SPHWHTL3DA0CF4T ☆Y6			
									SPHWHTL3DA0CF4R ◇Y6			
	5000									SPHWHTL3DA0CF4R ◇Z6		
5700									SPHWHTL3DA0CF4Q ◇Y6			
6500									SPHWHTL3DA0CF4P ◇Y6			

"☆" can be "0" (Whole bin), "P" (Quarter bin), or "M" (MacAdam 3-step ellipse bin) of the color binning

"◇" can be "T" (Half bin), "N" (MacAdam 5-step ellipse bin) of the color binning

a) Luminous Flux Bins ($I_f = 1050 \text{ mA}$, $T_j = 85 \text{ °C}$)

CRI/ Nominal CCT (K)	Flux rank													
	K2	M2	N2	P2	Q2	R2	S2	T2	U2	V2	W2	Y2		
	(min. flux)	260	280	300	320	340	360	380	400	420	440	460	480	
80	2700								SPHWHTL3DA0EF4W ☆S6					
	3000								SPHWHTL3DA0EF4W ☆T6					
										SPHWHTL3DA0EF4V ☆T6				
	3500									SPHWHTL3DA0EF4V ☆U6				
										SPHWHTL3DA0EF4U ☆T6				
	4000									SPHWHTL3DA0EF4U ☆U6				
										SPHWHTL3DA0EF4T ☆U6				
	5000										SPHWHTL3DA0EF4T ☆V6			
											SPHWHTL3DA0EF4R ◇U6			
	5300										SPHWHTL3DA0EF4R ◇V6			
											SPHWHTL3DA0EF4QRU6			
	5700										SPHWHTL3DA0EF4QRV6			
											SPHWHTL3DA0EF4Q ◇U6			
	6000										SPHWHTL3DA0EF4QRV6			
											SPHWHTL3DA0EF4PQU6			
	6500										SPHWHTL3DA0EF4PQV6			
										SPHWHTL3DA0EF4P ◇U6				
										SPHWHTL3DA0EF4P ◇V6				

"☆" can be "0" (Whole bin), "P" (Quarter bin), or "M" (MacAdam 3-step ellipse bin) of the color binning

"◇" can be "T" (Half bin), "N" (MacAdam 5-step ellipse bin) of the color binning

a) Luminous Flux Bins ($I_f = 1050 \text{ mA}$, $T_j = 85 \text{ }^\circ\text{C}$)

CRI/ Nominal CCT (K)	Flux rank												
	K2	M2	N2	P2	Q2	R2	S2	T2	U2	V2	W2	Y2	
	(min. flux)	260	280	300	320	340	360	380	400	420	440	460	480
90	2700		SPHWHTL3DA0GF4W ☆M6										
			SPHWHTL3DA0GF4W ☆N6										
	3000		SPHWHTL3DA0GF4V ☆N6										
			SPHWHTL3DA0GF4V ☆P6										
	3500		SPHWHTL3DA0GF4U ☆N6										
			SPHWHTL3DA0GF4U ☆P6										
	4000		SPHWHTL3DA0GF4T ☆P6										
			SPHWHTL3DA0GF4T ☆Q6										
	5000					SPHWHTL3DA0GF4R ◇R6							
							SPHWHTL3DA0GF4R ◇S6						
	5700						SPHWHTL3DA0GF4Q ◇S6						
	6000						SPHWHTL3DA0GF4PQR6						
						SPHWHTL3DA0GF4PQS6							

"☆" can be "0" (Whole bin), "P" (Quarter bin), or "M" (MacAdam 3-step ellipse bin) of the color binning

"◇" can be "T" (Half bin), "N" (MacAdam 5-step ellipse bin) of the color binning

b) Color Bins ($I_F = 1050 \text{ mA}$, $T_j = 85 \text{ }^\circ\text{C}$)

Nominal CCT (K)	CRI (R_a)	Color Rank	Chromaticity Bins
2700, 3000, 3500, 4000	70, 80, 90	☆0 (ANSI bin)	1, 2, 3, 4, 5, 6, 7, 8, 9, A, B, C, D, E, F, G
		☆P (Quarter bin)	6, 7, A, B
		☆M (MacAdam 3-step)	M
5300	80	☆T (Half bin)	1, 2, 3, 4
6000	80, 90	☆T (Half bin)	1, 2, 3, 4
5700, 6500	70, 80	☆T (Half bin)	1, 2, 3, 4
		☆N (MacAdam 5-step)	N
5000	70, 80, 90	☆T (Half bin)	1, 2, 3, 4
		☆N (MacAdam 5-step)	N

c) Voltage Bins ($I_F = 1050 \text{ mA}$, $T_j = 85 \text{ }^\circ\text{C}$)

Nominal CCT (K)	CRI (R_a) Min.	Product Code	Voltage Rank	Voltage Bin	Voltage Range (V)
-	-	-	F4	D2	2.6 ~ 2.8
				F2	2.8 ~ 3.0
				H2	3.0 ~ 3.2

d) Chromaticity Region & Coordinates ($I_f = 1050 \text{ mA}$, $T_j = 85 \text{ }^\circ\text{C}$)

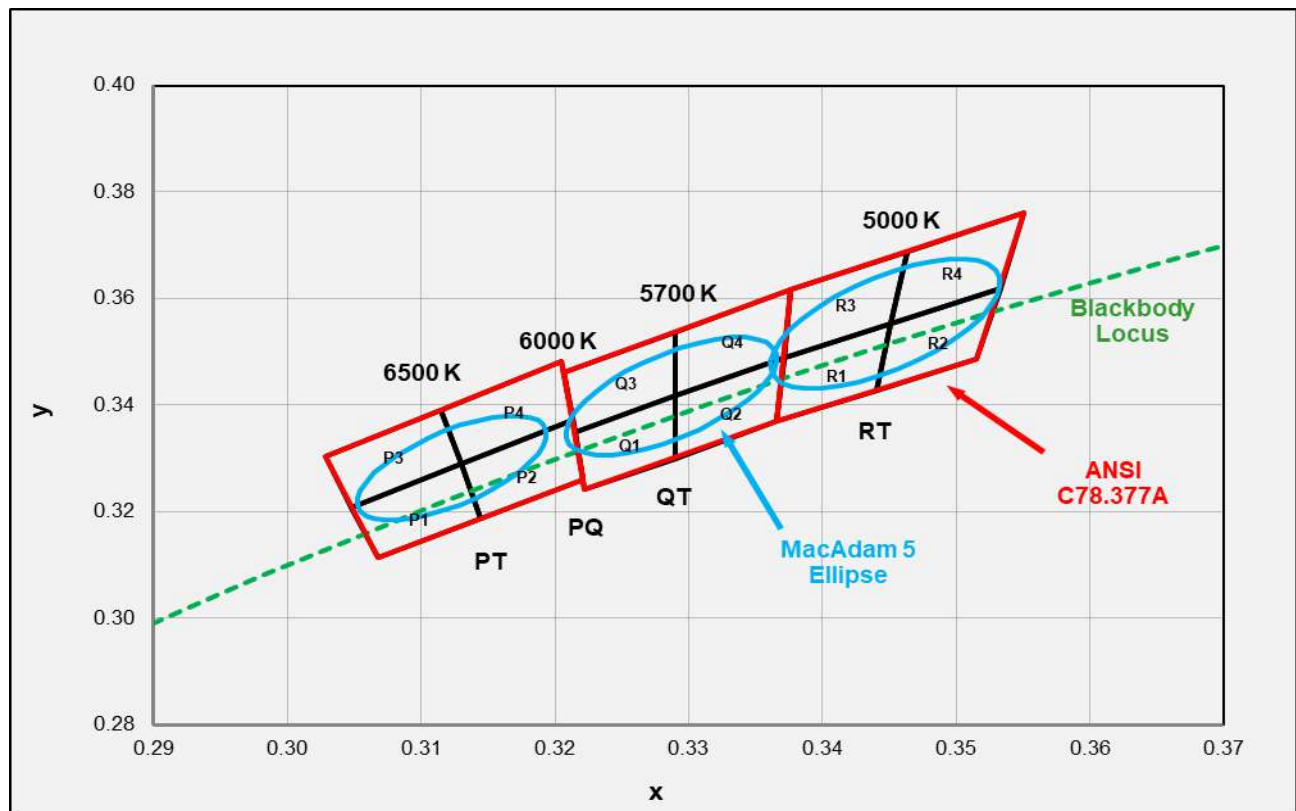
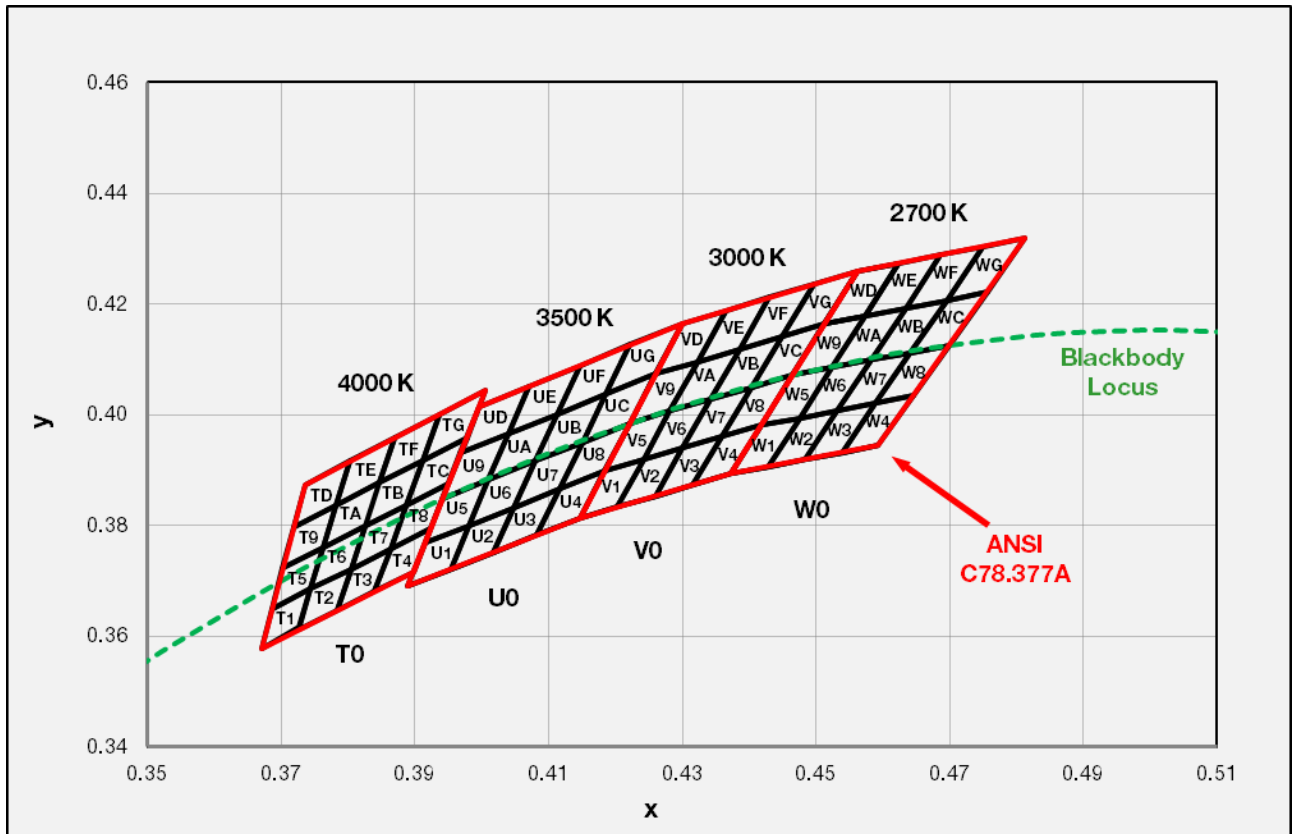

d) Chromaticity Region & Coordinates ($I_f = 1050 \text{ mA}$, $T_j = 85 \text{ }^\circ\text{C}$)

Region	CIE x	CIE y	Region	CIE x	CIE y
W rank (2700 K)					
W1	0.4373	0.3893	W9	0.4465	0.4071
	0.4418	0.3981		0.4513	0.4164
	0.4475	0.3994		0.4573	0.4178
	0.4428	0.3906		0.4523	0.4085
W2	0.4428	0.3906	WA	0.4523	0.4085
	0.4475	0.3994		0.4573	0.4178
	0.4532	0.4008		0.4634	0.4193
	0.4483	0.3919		0.4582	0.4099
W3	0.4483	0.3919	WB	0.4582	0.4099
	0.4532	0.4008		0.4634	0.4193
	0.4589	0.4021		0.4695	0.4207
	0.4538	0.3931		0.4641	0.4112
W4	0.4538	0.3931	WC	0.4641	0.4112
	0.4589	0.4021		0.4695	0.4207
	0.4646	0.4034		0.4756	0.4221
	0.4593	0.3944		0.4700	0.4126
W5	0.4418	0.3981	WD	0.4513	0.4164
	0.4465	0.4071		0.4562	0.4260
	0.4523	0.4085		0.4624	0.4274
	0.4475	0.3994		0.4573	0.4178
W6	0.4475	0.3994	WE	0.4573	0.4178
	0.4523	0.4085		0.4624	0.4274
	0.4582	0.4099		0.4687	0.4289
	0.4532	0.4008		0.4634	0.4193
W7	0.4532	0.4008	WF	0.4634	0.4193
	0.4582	0.4099		0.4687	0.4289
	0.4641	0.4112		0.4750	0.4304
	0.4589	0.4021		0.4695	0.4207
W8	0.4589	0.4021	WG	0.4695	0.4207
	0.4641	0.4112		0.4750	0.4304
	0.4700	0.4126		0.4813	0.4319
	0.4646	0.4034		0.4756	0.4221

Region	CIE x	CIE y	Region	CIE x	CIE y
V rank (3000 K)					
V1	0.4147	0.3814	V9	0.4221	0.3984
	0.4183	0.3898		0.4259	0.4073
	0.4242	0.3919		0.4322	0.4096
	0.4203	0.3833		0.4281	0.4006
V2	0.4203	0.3833	VA	0.4281	0.4006
	0.4242	0.3919		0.4322	0.4096
	0.4300	0.3939		0.4385	0.4119
	0.4259	0.3853		0.4342	0.4028
V3	0.4259	0.3853	VB	0.4342	0.4028
	0.4300	0.3939		0.4385	0.4119
	0.4359	0.3960		0.4449	0.4141
	0.4316	0.3873		0.4403	0.4049
V4	0.4316	0.3873	VC	0.4403	0.4049
	0.4359	0.3960		0.4449	0.4141
	0.4418	0.3981		0.4513	0.4164
	0.4373	0.3893		0.4465	0.4071
V5	0.4183	0.3898	VD	0.4259	0.4073
	0.4221	0.3984		0.4299	0.4165
	0.4281	0.4006		0.4364	0.4188
	0.4242	0.3919		0.4322	0.4096
V6	0.4242	0.3919	VE	0.4322	0.4096
	0.4281	0.4006		0.4364	0.4188
	0.4342	0.4028		0.4430	0.4212
	0.4300	0.3939		0.4385	0.4119
V7	0.4300	0.3939	VF	0.4385	0.4119
	0.4342	0.4028		0.4430	0.4212
	0.4403	0.4049		0.4496	0.4236
	0.4359	0.3960		0.4449	0.4141
V8	0.4359	0.3960	VG	0.4449	0.4141
	0.4403	0.4049		0.4496	0.4236
	0.4465	0.4071		0.4562	0.4260
	0.4418	0.3981		0.4513	0.4164

d) Chromaticity Region & Coordinates ($I_f = 1050 \text{ mA}$, $T_j = 85 \text{ }^\circ\text{C}$)

Region	CIE x	CIE y	Region	CIE x	CIE y
U rank (3500 K)					
U1	0.3889	0.3690	U9	0.3941	0.3848
	0.3915	0.3768		0.3968	0.3930
	0.3981	0.3800		0.4040	0.3966
	0.3953	0.3720		0.4010	0.3882
U2	0.3953	0.3720	UA	0.4010	0.3882
	0.3981	0.3800		0.4040	0.3966
	0.4048	0.3832		0.4113	0.4001
	0.4017	0.3751		0.4080	0.3916
U3	0.4017	0.3751	UB	0.4080	0.3916
	0.4048	0.3832		0.4113	0.4001
	0.4116	0.3865		0.4186	0.4037
	0.4082	0.3782		0.4150	0.3950
U4	0.4082	0.3782	UC	0.4150	0.3950
	0.4116	0.3865		0.4186	0.4037
	0.4183	0.3898		0.4259	0.4073
	0.4147	0.3814		0.4221	0.3984
U5	0.3915	0.3768	UD	0.3968	0.3930
	0.3941	0.3848		0.3996	0.4015
	0.4010	0.3882		0.4071	0.4052
	0.3981	0.3800		0.4040	0.3966
U6	0.3981	0.3800	UE	0.4040	0.3966
	0.4010	0.3882		0.4071	0.4052
	0.4080	0.3916		0.4146	0.4089
	0.4048	0.3832		0.4113	0.4001
U7	0.4048	0.3832	UF	0.4113	0.4001
	0.4080	0.3916		0.4146	0.4089
	0.4150	0.3950		0.4222	0.4127
	0.4116	0.3865		0.4186	0.4037
U8	0.4116	0.3865	UG	0.4186	0.4037
	0.4150	0.3950		0.4222	0.4127
	0.4221	0.3984		0.4299	0.4165
	0.4183	0.3898		0.4259	0.4073

Region	CIE x	CIE y	Region	CIE x	CIE y
T rank (4000 K)					
T1	0.3670	0.3578	T9	0.3702	0.3722
	0.3726	0.3612		0.3763	0.3760
	0.3744	0.3685		0.3782	0.3837
	0.3686	0.3649		0.3719	0.3797
T2	0.3726	0.3612	TA	0.3763	0.3760
	0.3783	0.3646		0.3825	0.3798
	0.3804	0.3721		0.3847	0.3877
	0.3744	0.3685		0.3782	0.3837
T3	0.3783	0.3646	TB	0.3825	0.3798
	0.3840	0.3681		0.3887	0.3836
	0.3863	0.3758		0.3912	0.3917
	0.3804	0.3721		0.3847	0.3877
T4	0.3840	0.3681	TC	0.3887	0.3837
	0.3898	0.3716		0.3950	0.3875
	0.3924	0.3794		0.3978	0.3958
	0.3863	0.3758		0.3912	0.3917
T5	0.3686	0.3649	TD	0.3719	0.3797
	0.3744	0.3685		0.3782	0.3837
	0.3763	0.3760		0.3802	0.3916
	0.3702	0.3722		0.3736	0.3874
T6	0.3744	0.3685	TE	0.3782	0.3837
	0.3804	0.3721		0.3847	0.3877
	0.3825	0.3798		0.3869	0.3958
	0.3763	0.3760		0.3802	0.3916
T7	0.3804	0.3721	TF	0.3847	0.3877
	0.3863	0.3758		0.3912	0.3917
	0.3887	0.3836		0.3937	0.4001
	0.3825	0.3798		0.3869	0.3958
T8	0.3863	0.3758	TG	0.3912	0.3917
	0.3924	0.3794		0.3978	0.3958
	0.3950	0.3875		0.4006	0.4044
	0.3887	0.3836		0.3937	0.4001

d) Chromaticity Region & Coordinates

Region	CIE x	CIE y	Region	CIE x	CIE y	Region	CIE x	CIE y	Region	CIE x	CIE y	Region	CIE x	CIE y		
R rank (5000 K)			QR rank (5300 K)			Q rank (5700 K)			PQ rank (6000 K)			P rank (6500 K)				
R1	0.3371	0.349	Q2	0.329	0.3417	Q1	0.3215	0.335	P2	0.3144	0.3186	P1	0.3068	0.3113		
	0.3451	0.3554		0.3371	0.349		0.329	0.3417		0.3221	0.3261		0.3144	0.3186	0.313	0.329
	0.344	0.3427		0.3366	0.3369		0.329	0.33		0.3213	0.3373		0.313	0.329	0.3048	0.3207
	0.3366	0.3369		0.329	0.33		0.3222	0.3243		0.313	0.329		0.3215	0.335	0.3144	0.3186
R2	0.3451	0.3554	R1	0.3371	0.349	Q2	0.329	0.3417	Q1	0.329	0.3417	P2	0.3221	0.3261		
	0.3533	0.362		0.3451	0.3554		0.3371	0.349		0.329	0.33		0.3215	0.335	0.3221	0.3261
	0.3515	0.3487		0.344	0.3427		0.3366	0.3369		0.329	0.33		0.329	0.335	0.3213	0.3373
	0.344	0.3427		0.3366	0.3369		0.329	0.33		0.3222	0.3243		0.313	0.329	0.3048	0.3207
R3	0.3376	0.3616	Q4	0.329	0.3538	Q3	0.3207	0.3462	P4	0.313	0.329	P3	0.3048	0.3207		
	0.3463	0.3687		0.3376	0.3616		0.329	0.3538		0.3213	0.3373		0.313	0.329	0.3144	0.3186
	0.3451	0.3554		0.3371	0.349		0.329	0.3417		0.3205	0.3481		0.3115	0.3391	0.3221	0.3261
	0.3371	0.349		0.329	0.3417		0.3215	0.335		0.3115	0.3391		0.3028	0.3304	0.3213	0.3373
R4	0.3463	0.3687	R3	0.3376	0.3616	Q4	0.329	0.3538	Q3	0.3207	0.3462	P4	0.313	0.329		
	0.3551	0.376		0.3463	0.3687		0.3376	0.3616		0.329	0.3538		0.3207	0.3462	0.3213	0.3373
	0.3533	0.362		0.3451	0.3554		0.3371	0.349		0.329	0.3417		0.329	0.3417	0.3205	0.3481
	0.3451	0.3554		0.3371	0.349		0.329	0.3417		0.3215	0.335		0.3115	0.3391	0.3028	0.3304

e) MacAdam Ellipse ($I_f = 1050 \text{ mA}$, $T_j = 85 \text{ }^\circ\text{C}$)

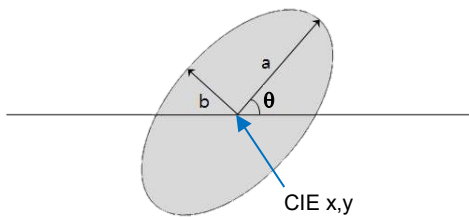

Nom. CCT (K)	Color Rank	Ellipse	Center		Rotation Angle θ ($^\circ$)	a	b
			CIE x	CIE y			
2200	YM	3-step	0.5018	0.4153	53.45	0.0072	0.0040
2700	WM	3-step	0.4578	0.4101	53.70	0.0081	0.0042
3000	VM	3-step	0.4338	0.4030	53.22	0.0083	0.0041
3500	UM	3-step	0.4073	0.3917	54.00	0.0093	0.0041
4000	TM	3-step	0.3818	0.3797	53.72	0.0094	0.0040
5000	RN	5-step	0.3447	0.3553	59.62	0.0137	0.0059
5700	QN	5-step	0.3287	0.3417	59.10	0.0125	0.0053
6500	PN	5-step	0.3123	0.3282	58.57	0.0116	0.0048

Note:

Samsung maintains measurement tolerance of: $C_x, C_y = \pm 0.005$

3. Typical Characteristics Graphs

a) Spectrum Distribution ($I_f = 1050 \text{ mA}$, $T_j = 85 \text{ }^\circ\text{C}$)

Cool White (CRI70)

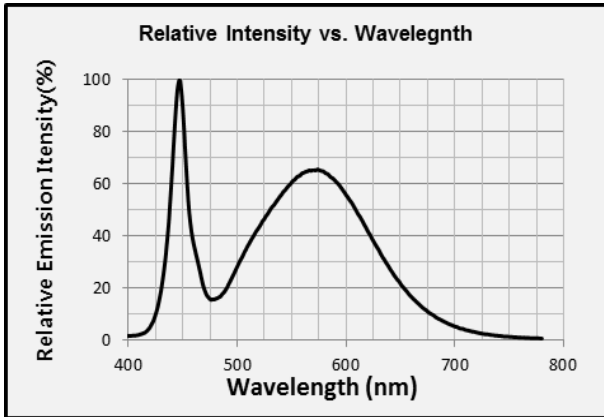

Warm White (CRI80)

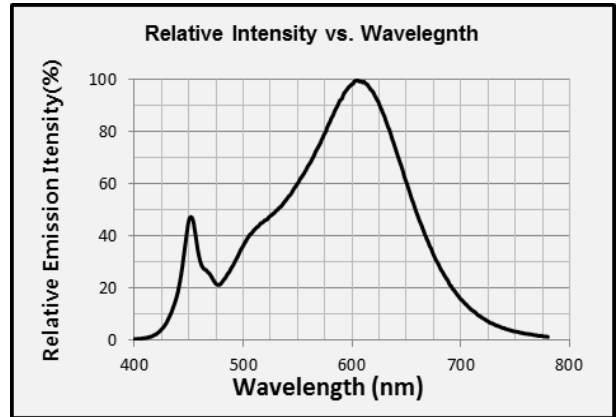

Cool White (CRI90)

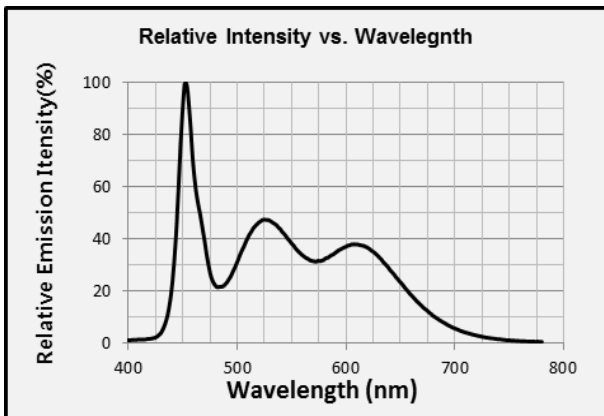

b) Forward Current Characteristics ($T_j = 85 \text{ }^\circ\text{C}$)

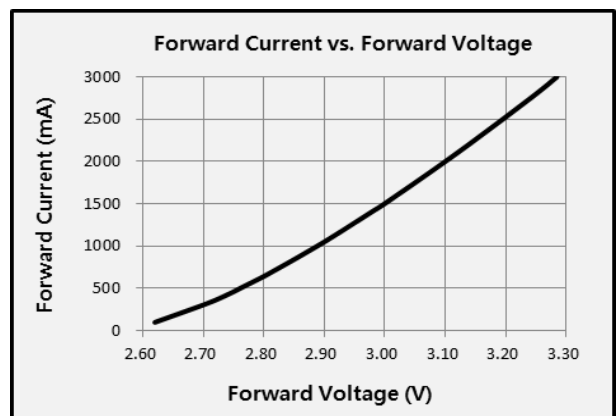
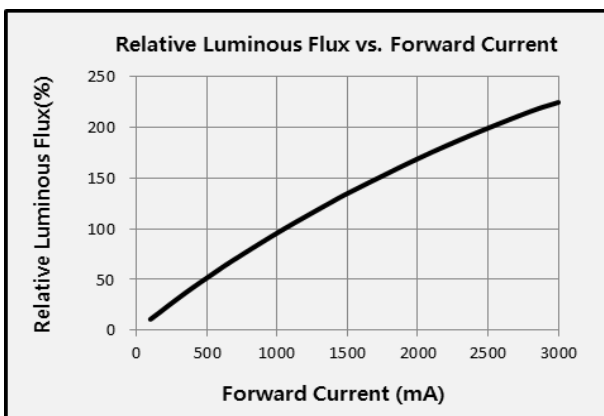

c) Temperature Characteristics ($I_f = 1050 \text{ mA}$)

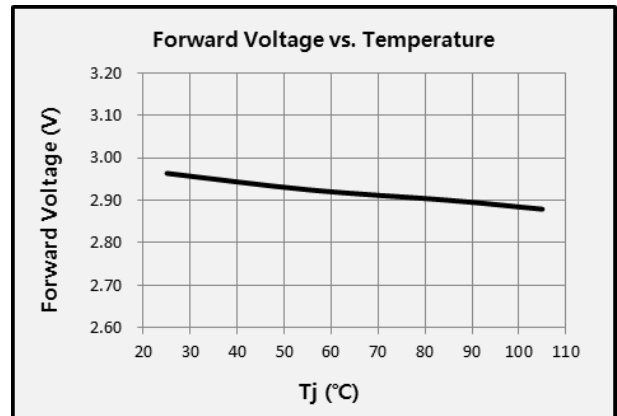
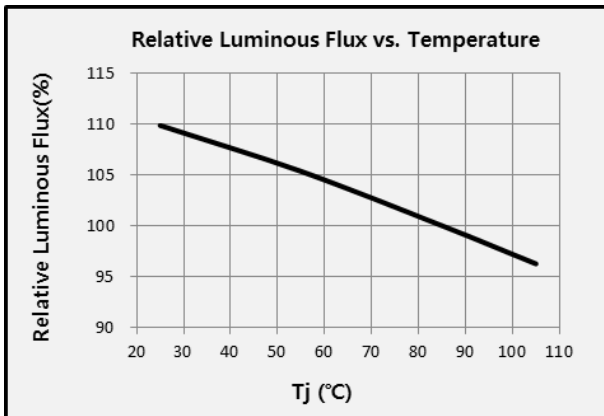

d) Color Shift Characteristics ($I_f = 1050 \text{ mA}$, $T_j = 85 \text{ °C}$)

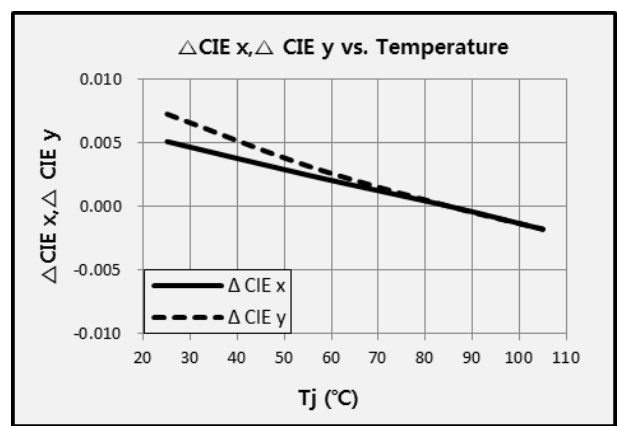
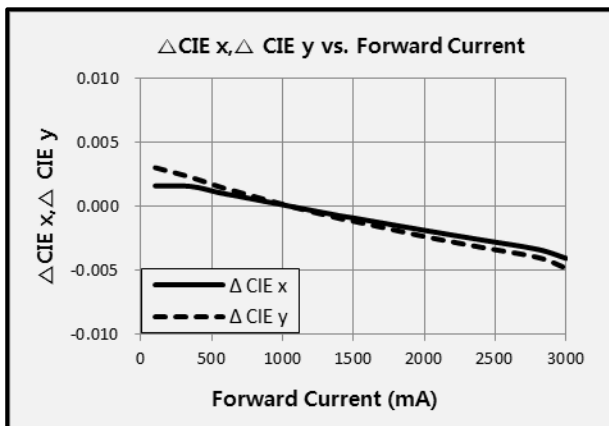

e) Derating Curve and Beam Angle Characteristics ($I_f = 1050 \text{ mA}$, $T_j = 25 \text{ °C}$)

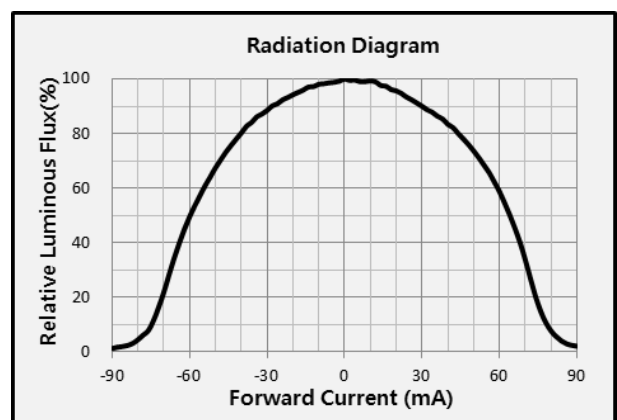
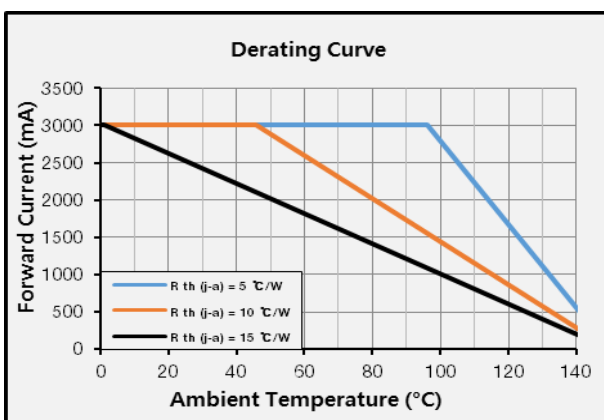

4. Outline Drawing & Dimension

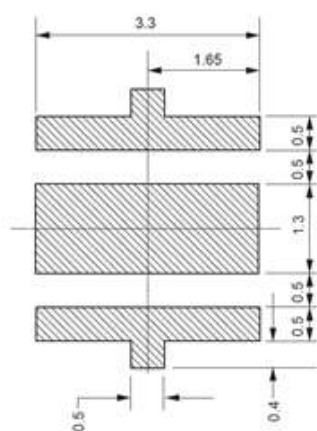
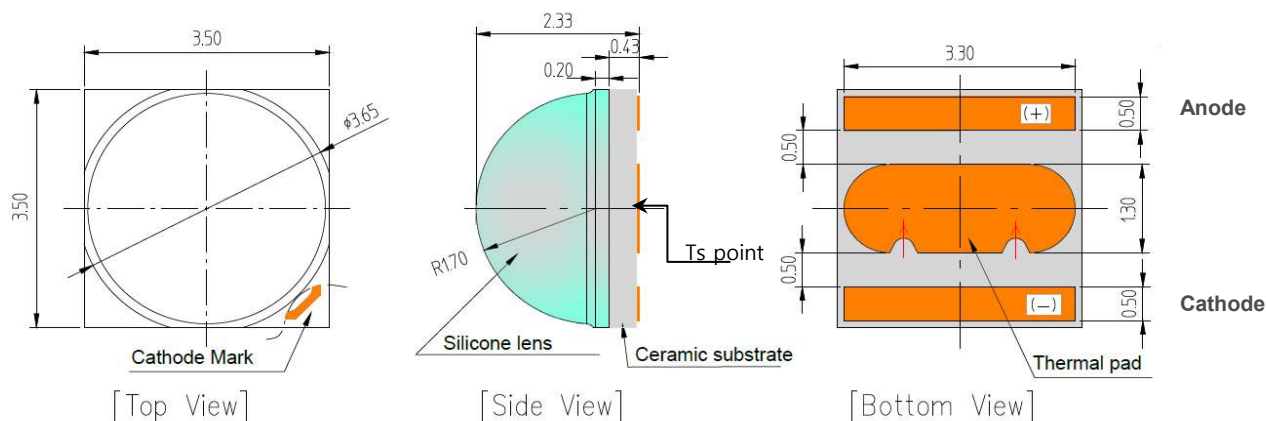

- Measurement unit: mm
- Tolerance: ± 0.13 mm

Recommended Soldering Pattern

Notes:

- 1) This LED has built-in ESD protection device(s) connected in parallel to LED chip(s).
- 2) The thermal pad is electrically isolated from the anode and cathode contact pads.
- 3) T_s point and measurement method:
 - ① Measure the nearest point to thermal pad as shown above. If necessary, remove PSR of PCB to reach T_s point.
 - ② All pads must be soldered to the PCB to dissipate heat properly, otherwise the LED can be damaged.

Precautions:

- 1) Pressure on the LEDs will influence to the reliability of the LEDs. Precautions should be taken to avoid strong pressure on the LEDs. Do not put stress on the LEDs during heating.
- 2) Re-soldering should not be done after the LEDs have been soldered. If re-soldering is unavoidable, LED's characteristics should be carefully checked before and after such repair.
- 3) Do not stack assembled PCBs together. Since materials of LEDs is soft, abrasion between two PCB assembled with LED might cause catastrophic failure of the LEDs.

5. Reliability Test Items & Conditions

a) Test Items

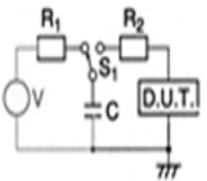
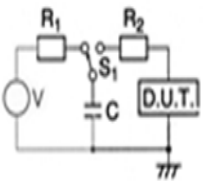
Test Item	Test Condition	Test Hour / Cycle
Room Temperature Life Test	25 °C, Maximum Rated Drive Current	1000 h
High Temperature Life Test	85 °C, Maximum Rated Drive Current	1000 h
High Temperature Humidity Life Test	85 °C, 85 % R.H., Maximum Rated Drive Current	1000 h
Low Temperature Life Test	-40 °C, Maximum Rated Drive Current	1000 h
Powered Temperature Cycle	-40 °C / 10 min ↔ 85 °C / 10 min, sweep 20 min cycle on/off: each 5 min, Maximum Rated Drive Current	1000 h
Damp Heat Cycling	-10 °C ↔ 25 °C/Dry ↔ 65 °C /95 % RH , 24 h / 1 cycle	10 cycles
Temperature Cycling	-45 °C / 15 min ↔ 125 °C / 15 min temperature change within 5 min	500 cycles
High Temperature Storage	120 °C	1000 h
High Temperature Humidity Storage	85 °C, 85 % R.H.	1000 h
ESD (HBM)	 <p> R_1: 10 MΩ R_2: 1.5 kΩ C: 100 pF V: ± 8 kV </p>	5 times
ESD (MM)	 <p> R_1: 10 MΩ R_2: 0 C: 200 pF V: ± 0.5 kV </p>	5 times
Vibration Test	20~2000~20 Hz, 200 m/s ² , sweep 4 min X, Y, Z 3 direction, each 1 cycle	4 cycles
Mechanical Shock Test	1500 g, 0.5 ms 3 shocks each X-Y-Z axis	5 cycles

b) Criteria for Judging the Damage

Item	Symbol	Test Condition ($T_j = 25$ °C)	Limit	
			Min.	Max.
Forward Voltage	V_F	$I_F = 1050$ mA	Init. Value * 0.9	Init. Value * 1.1
Luminous Flux	Φ_v	$I_F = 1050$ mA	Init. Value * 0.7	Init. Value * 1.1

6. Soldering Conditions

a) Reflow Conditions (Pb free)

Reflow frequency: 2 times max.

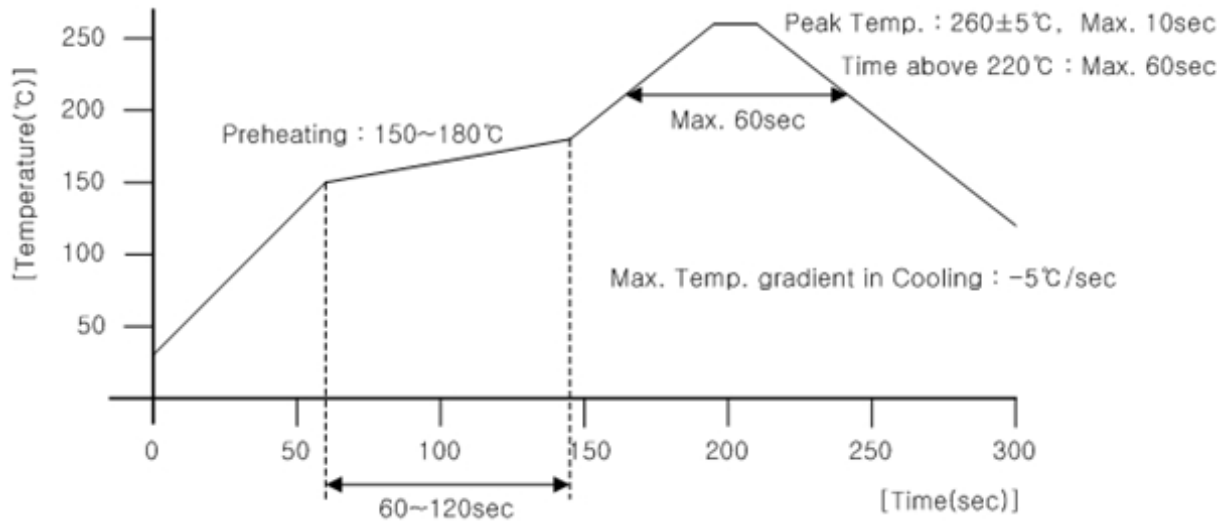

b) Manual Soldering Conditions

Not more than 5 seconds @ max. 300 °C, under soldering iron.

7. Tape & Reel

a) Taping Dimension

(unit: mm)

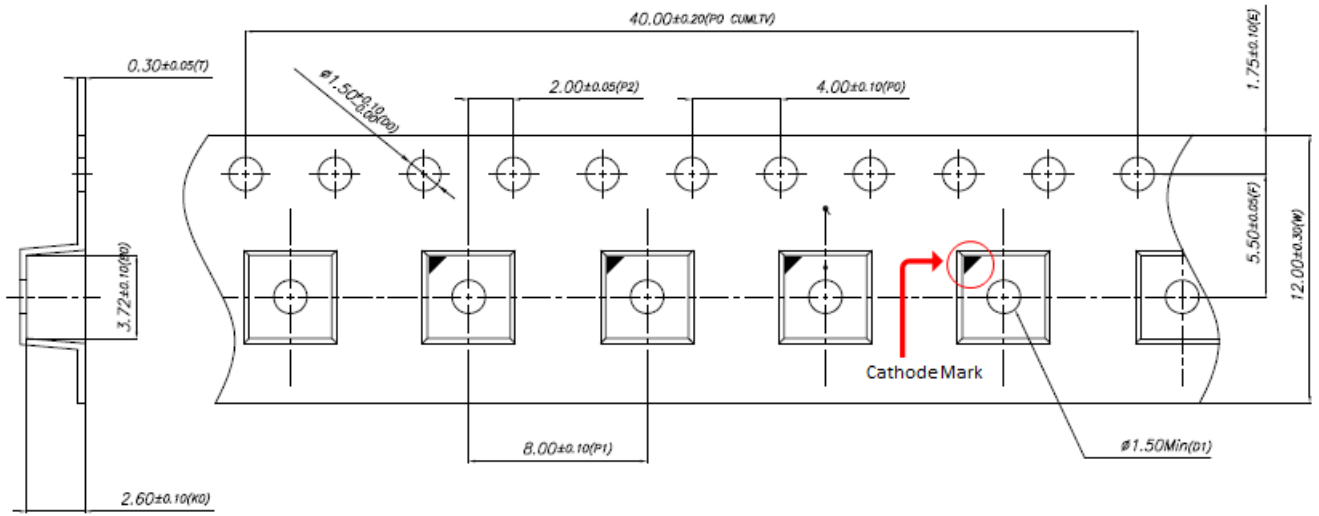

Taping Direction

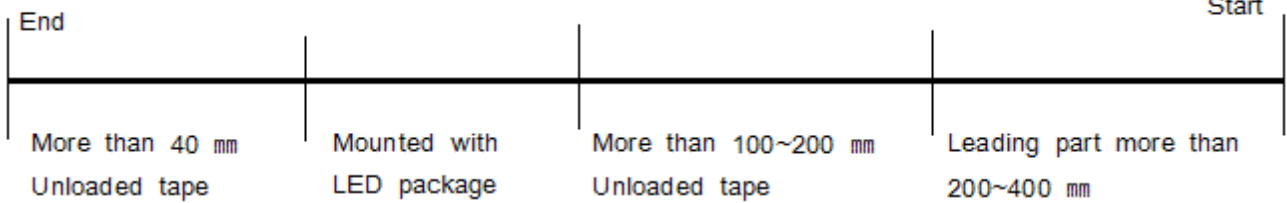

b) Reel Dimension

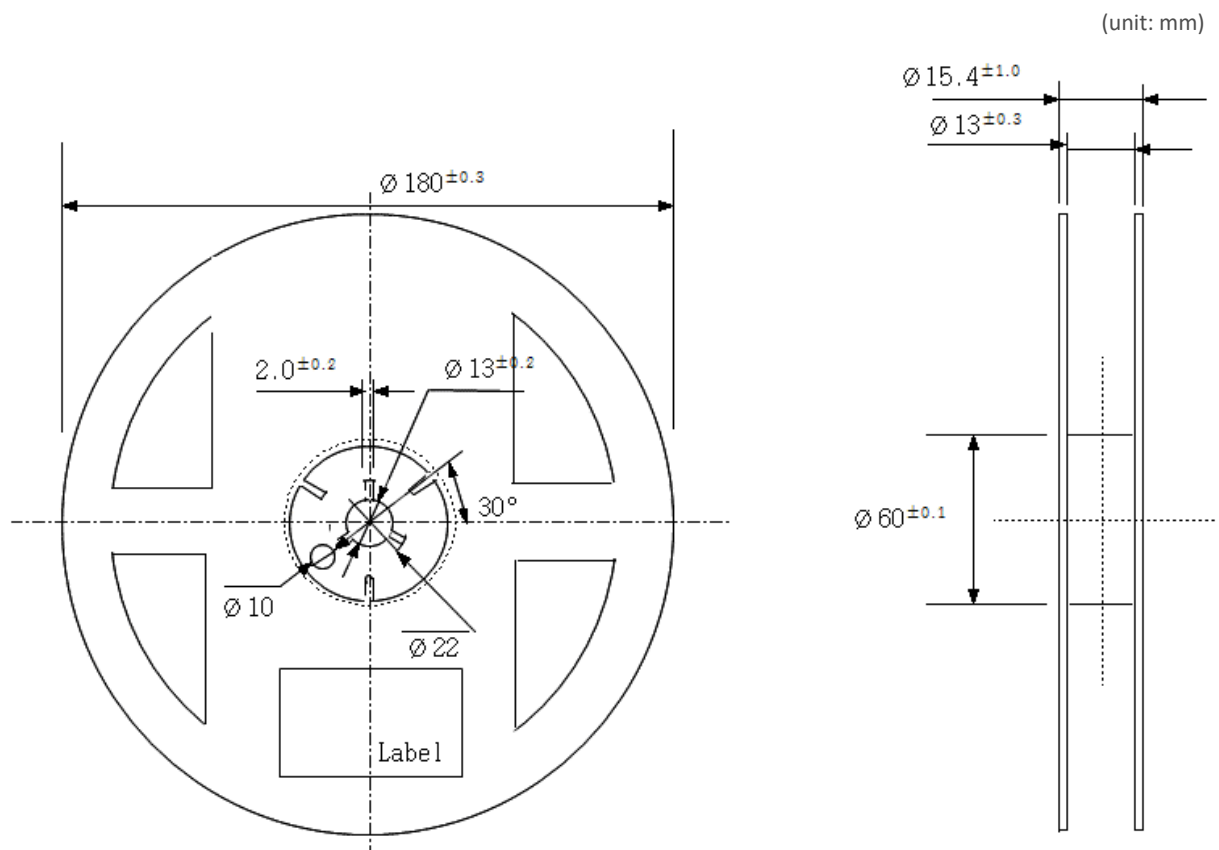

Notes:

- 1) Quantity: The quantity/reel is 800 pcs
- 2) Cumulative tolerance: Cumulative tolerance / 10 pitches is ± 0.2 mm
- 3) Adhesion strength of cover tape: Adhesion strength is 0.1-0.7 N when the cover tape is turned off from the carrier tape at 10° angle to the carrier tape
- 4) Packaging: P/N, Manufacturing data code no. and quantity are indicated on the aluminum packing bag

8. Label Structure

a) Label Structure

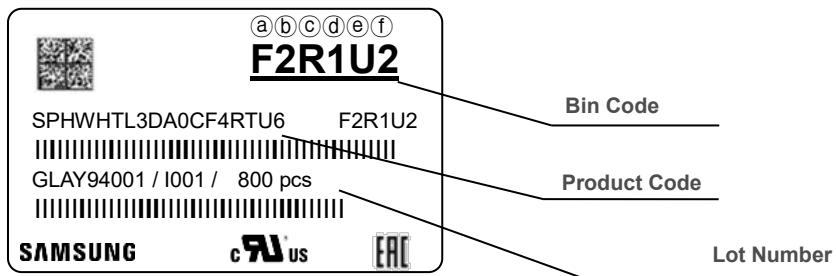

Note: Denoted bin code and product code above is only an example (see description on page 7)

Bin Code:

- a b : Forward Voltage bin (refer to page 9)
- c d : Chromaticity bin (refer to page 10~13)
- e f : Luminous Flux bin (refer to page 7-8)

b) Lot Number

The lot number is composed of the following characters:

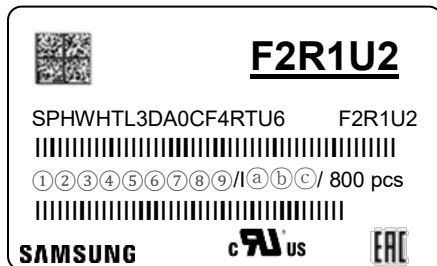

①②③④⑤⑥⑦⑧⑨ / I a b c / 800 pcs

- ①, ② : Production site (GB : Nanchang, China)
- ③ : Product state (A: Normal, B: Bulk, C: First Production, R: Reproduction, S: Sample)
- ④ : Year (Y: 2014, Z: 2015, A: 2016, B: 2017, C: 2018, D: 2019 ...)
- ⑤ : Month (1~9, A, B, C)
- ⑥ : Day (1~9, A, B~V)
- ⑦⑧⑨ : Product serial number (001 ~ 999)
- a b c : Reel number (001 ~ 999)

9. Packing Structure

a) Packing Process

Reel

F2R1U2
 SPHWHTL3DA0CF4RTU6 F2R1U2
 GLAY94001 / I001 / 800 pcs
SAMSUNG **US** **ERC**

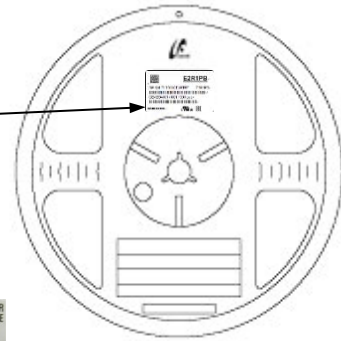

Aluminum Vinyl Packing Bag

F2R1U2
 SPHWHTL3DA0CF4RTU6 F2R1U2
 GLAY94001 / I001 / 800 pcs
SAMSUNG **US** **ERC**



Outer Box

Material: Paper SW(B)

Type	Size (mm)			Note
	(a)	(b)	(c)	
7 inch (L)	245 ± 5	220 ± 5	182 ± 5	Up to 8 reels
7 inch (S)	245 ± 5	220 ± 5	86 ± 5	Up to 4 reels

F2R1U2
 SPHWHTL3DA0CF4RTU6 F2R1U2
 GLAY94001 / I001 / 6,400 pcs
SAMSUNG **US** **ERC**

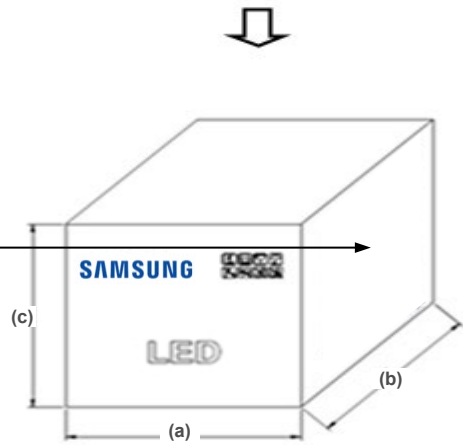

(1P) Supplier Part Number : SPHWHTL3DA0CF4RTU6 (Q) Quantity : 6,400
 (33P) Bin Code / F2R1U2 (100) Data Code : 1735
 (1T) Lot Number / GLAY94001 (4L) Country of Origin : KR

b) Aluminum Vinyl Packing Bag



CAUTION

This bag contains
MOISTURE SENSITIVE DEVICES

LEVEL
2a



F2R1U2

SPHWHTL3DA0CF4RTU6 F2R1U2

GLAY94001 / I001 / 800 pcs

SAMSUNG

US



1. Shelf life in sealed bag: 12 months at <40°C and <90% relative humidity (RH)

2. Peak package body temperature: 240 °C

3. After this bag is opened, devices that will be subjected to reflow solder or other high temperature processes must be:

- a. Mounted within 672 hours at factory conditions of equal to or less than 30°C / 60% RH, or
- b. Stored at <10% RH

4. Devices require bake, before mounting, if:

- a. Humidity Indicator Card is > 65% when read at 23±5°C, or
- b. 2a is not met.

5. If baking is required, devices must be baked for 1 hours at 60±5°C

Note: If device containers cannot be subjected to high temperature or shorter bake times are desired, reference IPC/JEDEC J-STD-033 for bake procedure.

Bag seal due date: _____

(if blank, see code label)

Note: Level and body temperature by IPC/JEDEC J-STD-020





주의 사항

이 알루미늄 지퍼 팩은 습기 및 정전기로부터 제품을 보호하기 위하여 제작되었습니다. 개봉 후에는 즉시 솔더 작업을 실시하는 것을 권장합니다.

습기 및 정전기로부터 제품을 보호 하기 위해서 개봉 후 사용하지 않는 자재는 본 팩에 넣어 보관 하시기 바랍니다. 사용하지 않는 자재를 본 팩에 넣을 때는 반드시 동봉된 드라이 팩과 함께 넣고 지퍼부분을 완전하게 밀봉하여 주시기 바랍니다.

Important

This Al Zipper bag is designed to protect the enclosed products from moisture and ESD. Once opened, the products should be soldered onto the printed circuit board immediately. When not in use, please do not leave the products unprotected by the Al Zipper Bag. To repack unused products., please ensure the zip-lock is completely sealed with the dry pack left inside.

c) Silica Gel & Humidity Indicator Card inside Aluminum Vinyl Bag

DESICCANT
SILICA
DO NOT
DE
SIL

HUMISAFE™

10% 20% 30% 40% 50% 60%



READ AT TOP OF GREEN COLOR
CHANGE BETWEEN YELLOW AND GREEN

**HUMIDITY INDICATOR
COBALT-FREE**

Warning If Green
Change Desiccant

GP&E Co., Ltd.
6CF-60NS

10. Precautions in Handling & Use

- 1) For over-current protection, users are recommended to apply resistors connected in series with the LEDs to mitigate sudden change of the forward current caused by shift of forward voltage.
- 2) This device should not be used in any type of fluid such as water, oil, organic solvent, etc. When cleaning is required, IPA is recommended as the cleaning agent. Some solvent-based cleaning agent may damage the silicone resins used in the device.
- 3) When the device is in operation, the forward current should be carefully determined considering the maximum ambient temperature and corresponding junction temperature.
- 4) LEDs must be stored in a clean environment. Shelf life of sealed bags is 12 months at temperature 0~40 °C, 0~90 % RH.
- 5) After storage bag is opened, device subjected to soldering, solder reflow, or other high temperature processes must be:
 - a. Mounted within 672 hours (28 days) at an assembly line with a condition of no more than 30 °C / 60 % RH, or
 - b. Stored at <10 % RH
- 6) Repack unused devices with anti-moisture packing, fold to close any opening and then store in a dry place.
- 7) Devices require baking before mounting, if humidity card reading is >60 % at 23 ± 5 °C.
- 8) Devices must be baked for 1 hour at 60 ± 5 °C, if baking is required.
- 9) The LEDs are sensitive to the static electricity and surge current. It is recommended to use a wrist band or anti-electrostatic glove when handling the LEDs. If voltage exceeding the absolute maximum rating is applied to LEDs, it may cause damage or even destruction to LED devices. Damaged LEDs may show some unusual characteristics such as increase in leakage current, lowered turn-on voltage, or abnormal lighting of LEDs at low current.
- 10) VOCs (Volatile Organic Compounds) can be generated from adhesives, flux, hardener or organic additives used in luminaires (fixtures). Transparent LED silicone encapsulant is permeable to those chemicals and they may lead to a discoloration of encapsulant when they exposed to heat or light. This phenomenon can cause a significant loss of light emitted (output) from the luminaires. In order to prevent these problems, we recommend users to know the physical properties of materials used in luminaires and they must be carefully selected.

Legal and additional information.

[About Samsung Electronics Co., Ltd.](#)

Samsung Electronics Co., Ltd. inspires the world and shapes the future with transformative ideas and technologies, redefining the worlds of TVs, smartphones, wearable devices, tablets, cameras, digital appliances, printers, medical equipment, network systems and semiconductors.

We are also leading in the Internet of Things space through, among others, our Digital Health and Smart Home initiatives. We employ 307,000 people across 84 countries. To discover more, please visit our official website at www.samsung.com and our official blog at global.samsungtomorrow.com.

“Samsung provides limited warranty for its LED products, the full text of which is available at <https://www.samsung.com/led/support/warranties>“

Copyright © 2017 Samsung Electronics Co., Ltd. All rights reserved.

Samsung is a registered trademark of Samsung Electronics Co., Ltd.

Specifications and designs are subject to change without notice. Non-metric weights and measurements are approximate. All data were deemed correct at time of creation. Samsung is not liable for errors or omissions. All brand, product, service names and logos are trademarks and/or registered trademarks of their respective owners and are hereby recognized and acknowledged.

Samsung Electronics Co., Ltd.

1, Samsung ro

Giheung-gu

Yongin-si, Gyeonggi-do, 17113

KOREA

www.samsungled.com

The Samsung logo, consisting of the word "SAMSUNG" in a bold, blue, sans-serif font.