

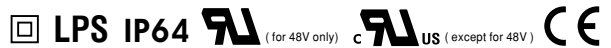

■ Features :

- Universal AC input / Full range
- Protections: Short circuit / Over current / Over voltage
- Cooling by free air convection
- Built-in constant current limiting circuit with adjustable OCP level
- Optional dimming function : 1~10VDC (D type) or PWM (P type) controlled
- Fully isolated plastic case with IP64 level
- Class II power unit, no FG
- Class 2 power unit
- Pass LPS
- Suitable for LED lighting and moving sign applications (Note.9)
- 100% full load burn-in test
- Low cost, high reliability
- 2 years warranty

SPECIFICATION



MODEL		ELN-60-9	ELN-60-12	ELN-60-15	ELN-60-24	ELN-60-27	ELN-60-48		
OUTPUT	DC VOLTAGE	9V	12V	15V	24V	27V	48V		
	LED OPERATION VOLTAGE Note.8	3 ~ 9V	6 ~ 12V	7.5 ~ 15V	12 ~ 24V	13.5 ~ 27V	24 ~ 48V		
	RATED CURRENT	5A	5A	4A	2.5A	2.3A	1.3A		
	CURRENT RANGE	0 ~ 5A	0 ~ 5A	0 ~ 4A	0 ~ 2.5A	0 ~ 2.3A	0 ~ 1.3A		
	RATED POWER	45W	60W	60W	60W	62.1W	62.5W		
	RIPPLE & NOISE (max.) Note.2	120mVp-p	120mVp-p	150mVp-p	150mVp-p	200mVp-p	250mVp-p		
	VOLTAGE ADJ. RANGE Note.7	8.7 ~ 10.5V	10.8 ~ 13.2V	13.5 ~ 16.5V	21.6 ~ 26.4V	24.3 ~ 29.7V	43.2 ~ 52.8V		
	Can be adjusted by internal potentiometer SVR1								
	CURRENT ADJ. RANGE Note.7	-25% ~ 3%. Can be adjusted by internal potentiometer SVR2							
	VOLTAGE TOLERANCE Note.3	±5.0%							
	LINE REGULATION	±1.0%							
LOAD REGULATION	±2.0%								
SETUP, RISE TIME Note.6	500ms, 30ms / 230VAC 1500ms, 30ms / 115VAC at full load								
HOLD UP TIME (Typ.)	50ms/230VAC 16ms/115VAC at full load								
INPUT	VOLTAGE RANGE Note.4	90 ~ 264VAC		127 ~ 370VDC					
	FREQUENCY RANGE	47 ~ 63Hz							
	EFFICIENCY (Typ.)	82%	85%	86%	87%	87%	88%		
	AC CURRENT (Typ.)	1.2A/115VAC 0.7A/230VAC							
	INRUSH CURRENT (Typ.)	COLD START 60A(twidth=600µs measured at 50% Ipeak) at 230VAC							
	MAX. No. of PSUs on 16A CIRCUIT BREAKER	3 units (circuit breaker of type B) / 5 units (circuit breaker of type C) at 230VAC							
LEAKAGE CURRENT	0.25mA / 240VAC								
PROTECTION	OVER CURRENT	95 ~ 110%							
	Protection type : Constant current limiting, recovers automatically after fault condition is removed								
OVER VOLTAGE	11 ~ 13.5V		13.8 ~ 16V		17.5 ~ 21V		28 ~ 32V		
	31 ~ 37V		54 ~ 60V		Protection type : Shut down o/p voltage, re-power on to recover				
FUNCTION	DIMMING CONTROL (OPTIONAL)	1 ~ 10VDC or PWM signal : 100Hz ~ 3KHz							
ENVIRONMENT	WORKING TEMP.	-20 ~ +60°C (Refer to "Derating Curve")							
	WORKING HUMIDITY	20 ~ 90% RH non-condensing							
	STORAGE TEMP., HUMIDITY	-40 ~ +80°C, 10 ~ 95% RH							
	TEMP. COEFFICIENT	±0.03%/°C (0 ~ 50°C)							
	VIBRATION	10 ~ 500Hz, 2G 10min./1cycle, period for 60min. each along X, Y, Z axes							
SAFETY & EMC	SAFETY STANDARDS	UL1310, CAN/CSA C22.2 No. 223-M91(except for 48V), IP64 approved ; design refer to TUV EN60950-1							
	WITHSTAND VOLTAGE	I/P-O/P:3KVAC							
	ISOLATION RESISTANCE	I/P-O/P:>100M Ohms / 500VDC / 25°C/ 70% RH							
	EMC EMISSION	Compliance to EN55032 (CISPR32) Class B, EN61000-3-2 Class A, EN61000-3-3							
	EMC IMMUNITY	Compliance to EN61000-4-2,3,4,5,6,8,11, EN55024, light industry level, criteria A							
OTHERS	MTBF	603Khrs min. MIL-HDBK-217F (25°C)							
	DIMENSION	181*61.5*35mm (L*W*H)							
	PACKING	0.4Kg; 24pcs/11Kg/0.75CUFT							
NOTE	<ol style="list-style-type: none"> 1. All parameters NOT specially mentioned are measured at 230VAC input, rated load and 25°C of ambient temperature. 2. Ripple & noise are measured at 20MHz of bandwidth by using a 12" twisted pair-wire terminated with a 0.1µf & 47µf parallel capacitor. 3. Tolerance : includes set up tolerance, line regulation and load regulation. 4. Derating may be needed under low input voltage. Please check the static characteristics for more details. 5. The power supply is considered as a component that will be operated in combination with final equipment. Since EMC performance will be affected by the complete installation, the final equipment manufacturers must re-qualify EMC Directive on the complete installation again. 6. Length of set up time is measured at first cold start. Turning ON/OFF the power supply may lead to increase of the set up time. 7. Output voltage can be adjusted through the SVR1 on the PCB ; limit of output constant current level can be adjusted through the SVR2 on the PCB. 8. Constant current operation region is within the specified output voltage range above. This is the suitable operation region for LED related applications. 9. The unit might not be suitable for lighting applications in EU countries. Please check with your local authorities for the possible use of the unit. 								

Mechanical Specification

Case No.960A Unit:mm

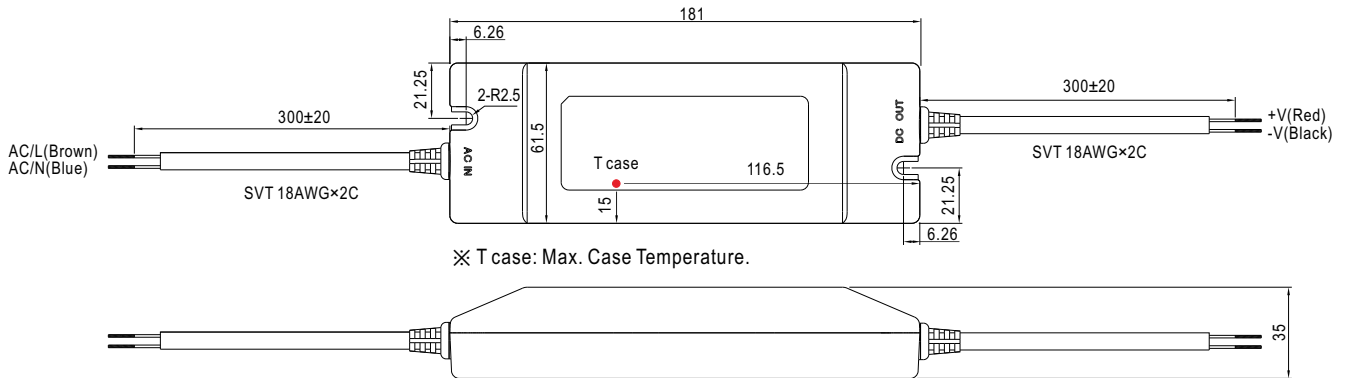

※ T case: Max. Case Temperature.

Output voltage and current adjustment : remove the upper case and adjust through SVR1 & SVR2 shown in the diagram.

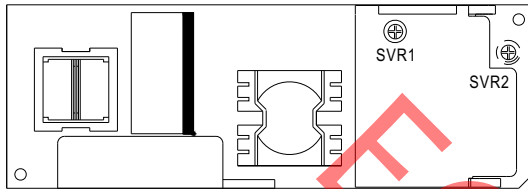

SVR1	Output voltage adjustment
SVR2	Output current adjustment

OUTPUT(with optional dimming function)

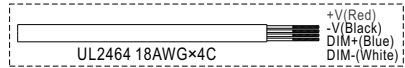

Block Diagram

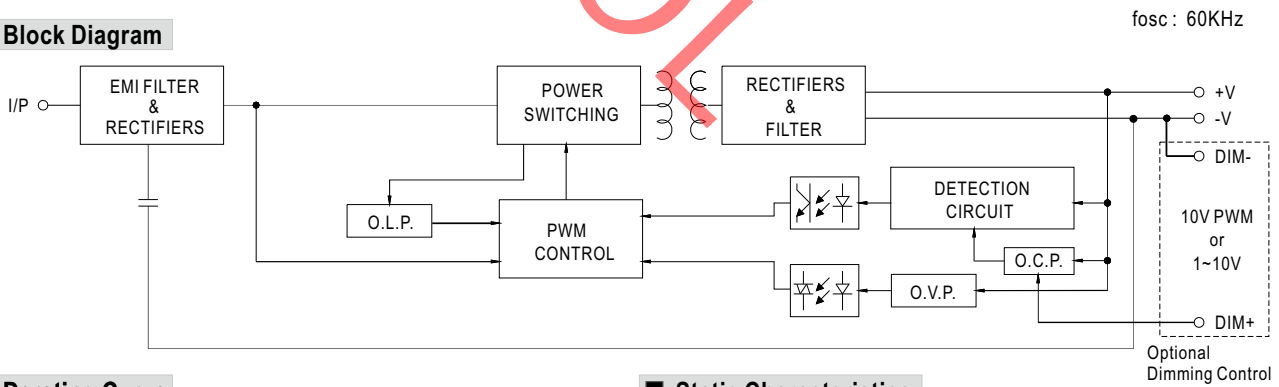

Derating Curve

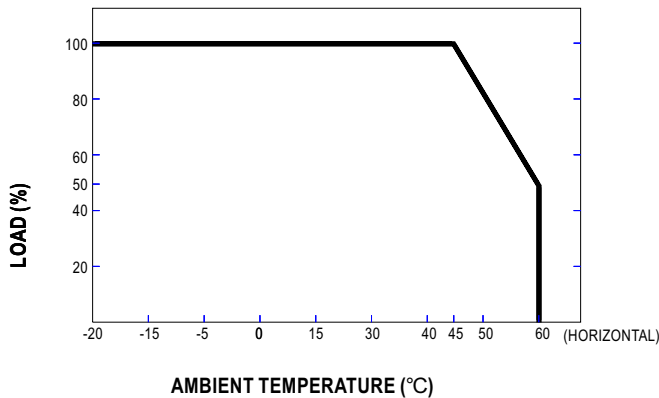

Static Characteristics

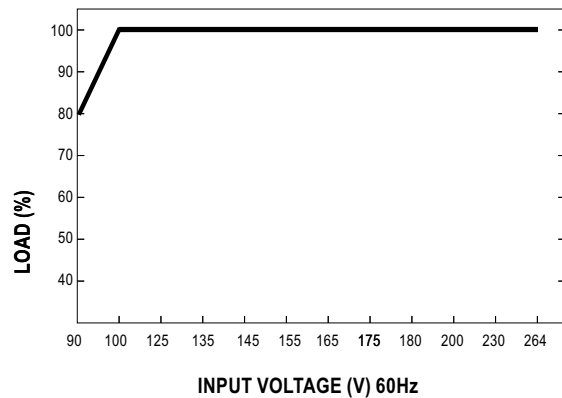

■ **Dimming Control (Optional)**

Level of output current can be adjusted through the dimming control function.

When there is no signal sending to the control wires (open circuit between the two control wires), the power supply unit will operate as 0V (D-type) or 0% duty (P-type) of input signal and hence the output current will be zero.

(1) 1~10V (D type, & : ELN-60-12D)

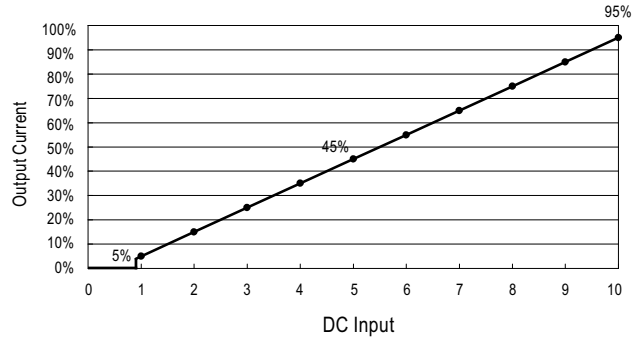
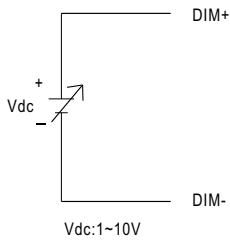

(2) PWM (P type, & : ELN-60-12P)

