

## Part Number: D312640Q

### Electrical Specifications

Frequency Range (GHz):	26.5 – 40.0
Isolation (dB):	14 MIN
Insertion Loss (dB):	1.0 MAX
VSWR:	1.5:1 MIN
Forward Power (W):	5 AVG 30 PK
Reflective Power (W):	2 AVG

### Mechanical/Environmental Specifications

Connector Type:	2.4mm
Connector Body:	Passivated stainless steel
Connector Pin:	Gold plated copper
Load Body:	Brass
Magnetic Shunt:	Nickel plated CRS
Operational Temp:	-20°C to +65°C
Weight (oz)	0.9 MAX

### D312640Q Dimensions

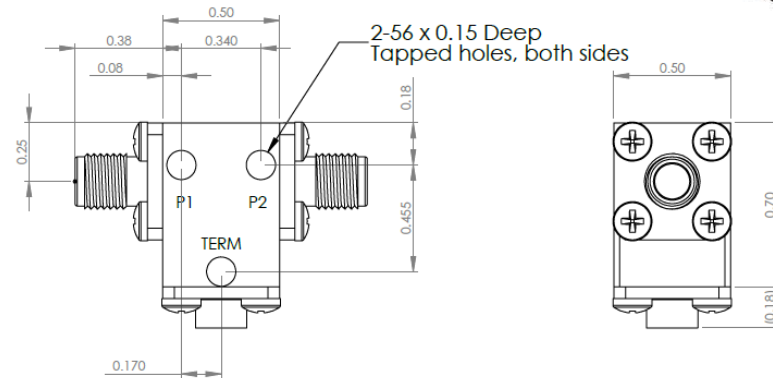

### D312640Q-3 Dimensions

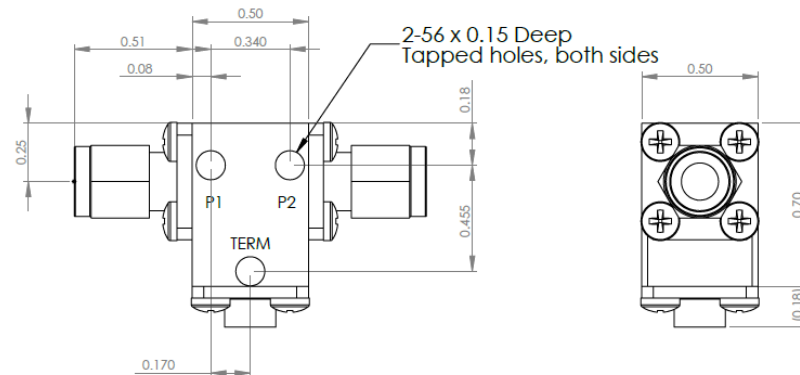

Dimensions are in inches  
Tolerance

XX	±0.03
XXX	±0.010

Type of Device	PN Suffix	Connector Configuration Input / Output	PN Example
Single and Dual Junction Isolator, 2-Port Device	N/A	Female / Female	D312640Q
	-1	Male / Female	D312640Q-1
	-2	Female / Male	D312640Q-2
	-3	Male / Male	D312640Q-3



# MEASURED DATA

Part Number: D3I2640Q, +25°C

