

Mechanical Dimensions: Inches [mm]

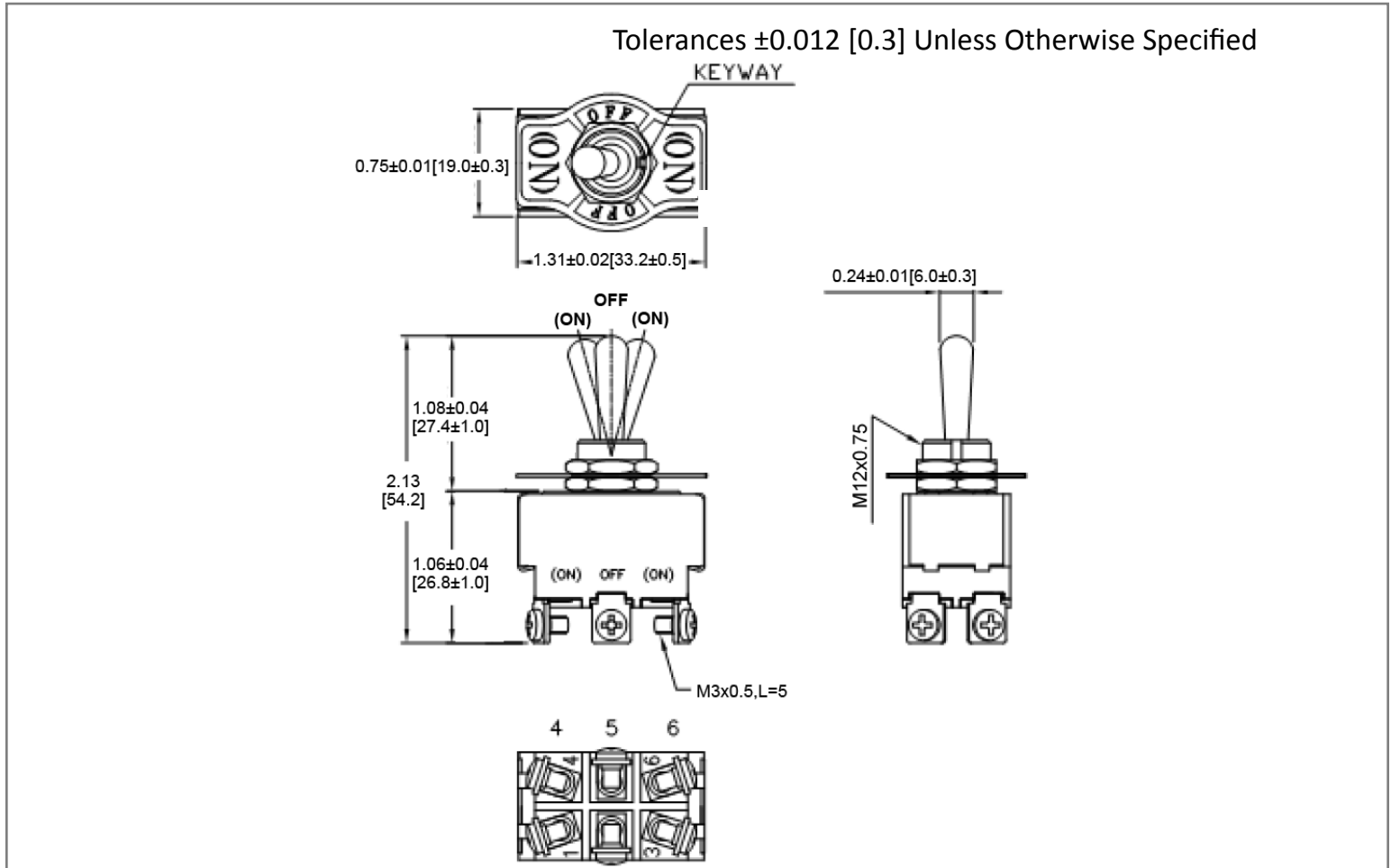

Mounting Hole

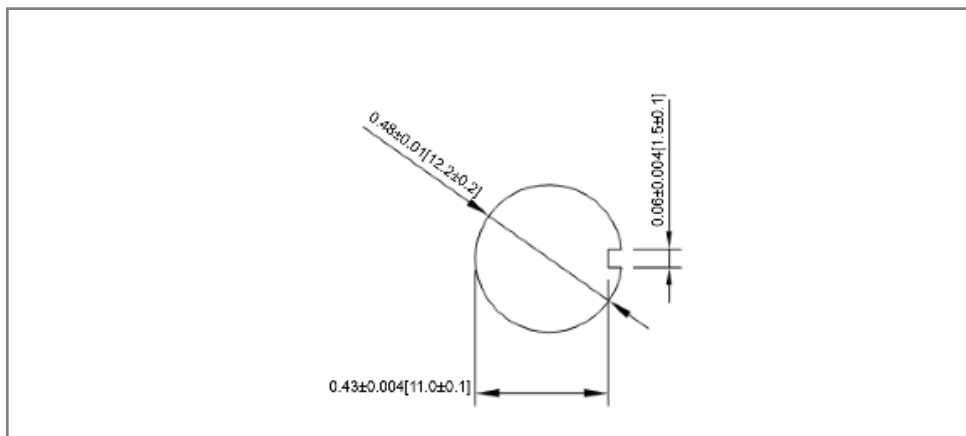

Circuit Diagram

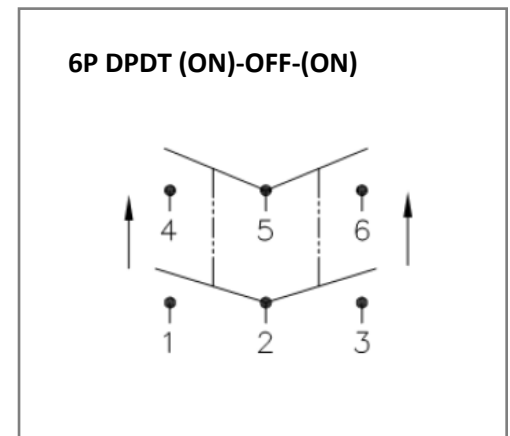

Electrical Specifications

Rating	20A 12V DC, 10A 24V DC
Contact Resistance	50m ohm Max
Insulation Resistance	DC 500V 100M ohm Min
Dielectric Strength	AC 1500V 1 minute
Operation Temperature	0°C~55°C

Material Specifications

2 HEX NUT ASSY
1 ON/OFF/ON FACE PLATE ASSY

Rev **Date of issue** **Revision Notes**

Designed **Approved**

B	02-26-2020	Initial Drawing	RC	OF
---	------------	-----------------	----	----