

## VIOLETTA-W

~60° wide beam

### SPECIFICATION:

Dimensions	21.7 x 21.7 mm
Height	6.5 mm
Fastening	pin
ROHS compliant	yes ⓘ

### MATERIALS:

Component	Type	Material	Colour	Finish
VIOLETTA-W	Single lens	Silicone	clear	gloss

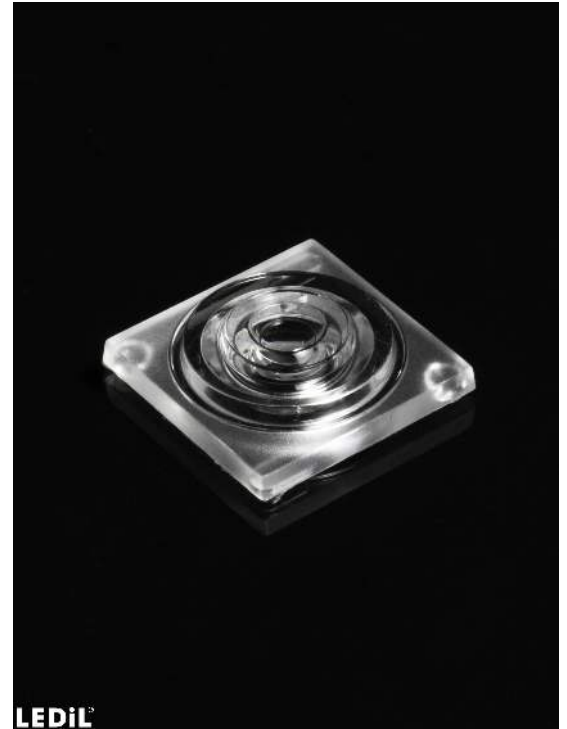

### ORDERING INFORMATION:

Component	Qty in box	MOQ	MPQ	Box weight (kg)
F17826_VIOLETTA-W » Box size: 485 x 280 x 100 mm	2025	270	135	4.3

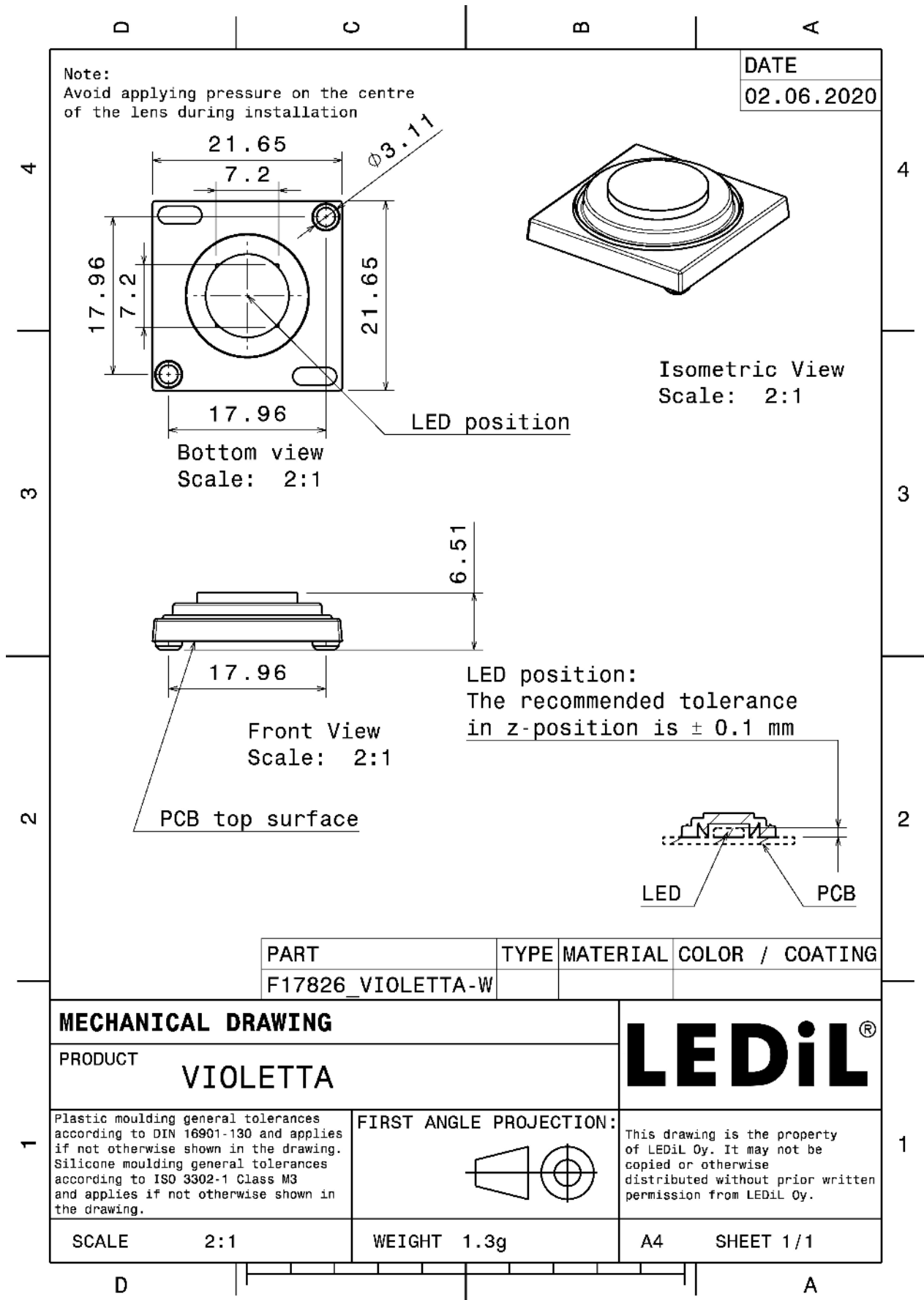

See also our general installation guide: [www.ledil.com/installation\\_guide](http://www.ledil.com/installation_guide)

### OPTICAL RESULTS (MEASURED):



LED Bolb UV-C 6060 SMD  
FWHM / FWTM 56.0° / 74.0°  
Efficiency 64 %  
LEDs/each optic 1  
Light colour UV-C  
Required components:

The UVC LED result tolerance is  $\pm 10$  %



LED CLH-N3S  
FWHM / FWTM 53.0° / 73.0°  
Efficiency 82 %  
LEDs/each optic 1  
Light colour UV-C  
Required components:

The UVC LED result tolerance is  $\pm 10$  %



LED KL265-50V-SM-WD  
FWHM / FWTM 48.0° / 68.0°  
Efficiency 62 %  
LEDs/each optic 1  
Light colour UV-C  
Required components:

The UVC LED result tolerance is  $\pm 10$  %



LED S3535-DR100-W272-P40  
FWHM / FWTM 52.0° / 72.0°  
Efficiency 81 %  
LEDs/each optic 1  
Light colour UV-C  
Required components:

The UVC LED result tolerance is  $\pm 10$  %

### OPTICAL RESULTS (MEASURED):



LED XFM-5050 2 Die  
FWHM / FWTM 56.0° / 74.0°  
Efficiency 65 %  
LEDs/each optic 1  
Light colour UV-C  
Required components:

The UVC LED result tolerance is  $\pm 10$  %



LED XFM-5050 3 Die  
FWHM / FWTM 55.0° / 73.0°  
Efficiency 78 %  
LEDs/each optic 1  
Light colour UV-C  
Required components:

The UVC LED result tolerance is  $\pm 10$  %



LED OSLON UV 3636 (SU CULBN1.VC)  
FWHM / FWTM 54.0° / 76.0°  
Efficiency 77 %  
LEDs/each optic 1  
Light colour UV-C  
Required components:

The UVC LED result tolerance is  $\pm 10$  %



LED OSLON UV 3636 (SU CULDN1.VC)  
FWHM / FWTM 57.0° / 79.0°  
Efficiency 80 %  
LEDs/each optic 1  
Light colour UV-C  
Required components:

The UVC LED result tolerance is  $\pm 10$  %

### OPTICAL RESULTS (MEASURED):

#### OSRAM

Opto Semiconductors

LED OSLON UV 6060 (SU CZHEF1.VC)  
FWHM / FWTM 53.0° / 72.0°  
Efficiency 71 %  
LEDs/each optic 1  
Light colour UV-C  
Required components:

The UVC LED result tolerance is  $\pm 10$  %

#### OSRAM

Opto Semiconductors

LED OSLON UV 6060 (SU CZHPF1.VC)  
FWHM / FWTM 53.0° / 72.0°  
Efficiency 75 %  
LEDs/each optic 1  
Light colour UV-C  
Required components:

The UVC LED result tolerance is  $\pm 10$  %

#### SAMSUNG

LED UV351A  
FWHM / FWTM 58.0° / 77.0°  
Efficiency 80 %  
LEDs/each optic 1  
Light colour UV-C  
Required components:

The UVC LED result tolerance is  $\pm 10$  %

#### SAMSUNG

LED UV351B  
FWHM / FWTM 51.0° / 74.0°  
Efficiency 78 %  
LEDs/each optic 1  
Light colour UV-C  
Required components:

The UVC LED result tolerance is  $\pm 10$  %

### OPTICAL RESULTS (MEASURED):

#### SAMSUNG

LED UV352B  
FWHM / FWTM 60.0° / 77.0°  
Efficiency 79 %  
LEDs/each optic 1  
Light colour UV-C  
Required components:

The UVC LED result tolerance is  $\pm 10$  %

#### SAMSUNG

LED UV353B  
FWHM / FWTM 59.0° / 78.0°  
Efficiency 79 %  
LEDs/each optic 1  
Light colour UV-C  
Required components:

The UVC LED result tolerance is  $\pm 10$  %

#### STANLEY

LED ZEUBE265 Series  
FWHM / FWTM 43.0° / 63.0°  
Efficiency 71 %  
LEDs/each optic 1  
Light colour UV-C  
Required components:

The UVC LED result tolerance is  $\pm 10$  %

### OPTICAL RESULTS (SIMULATED):

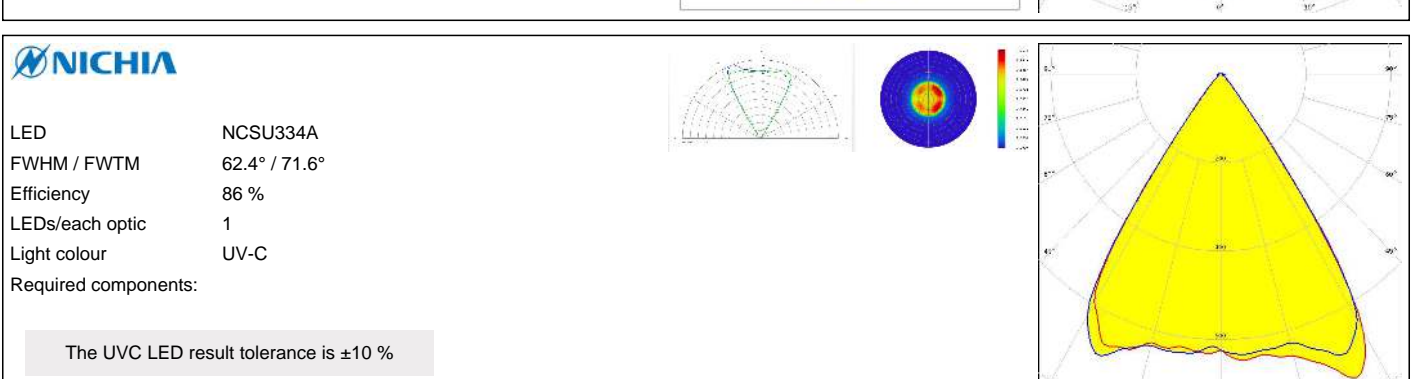
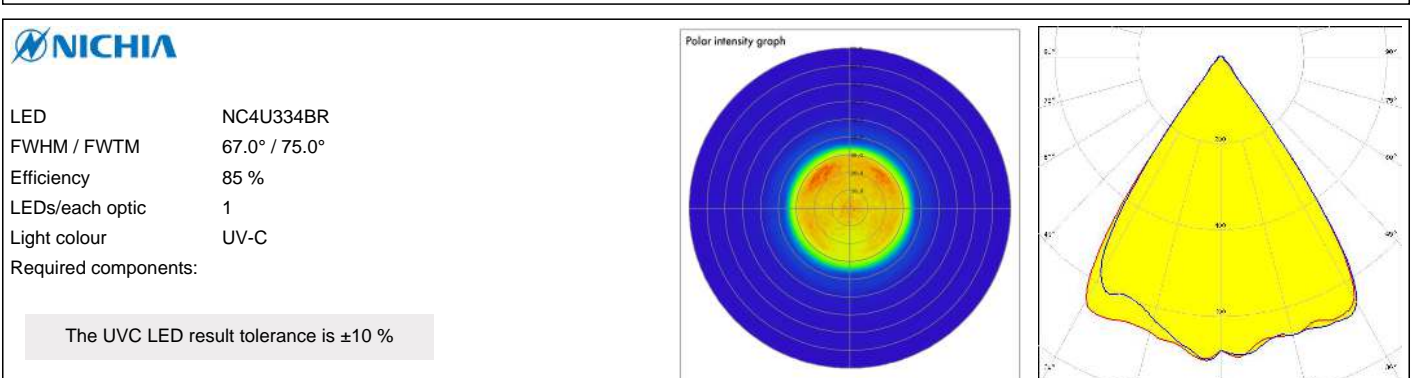
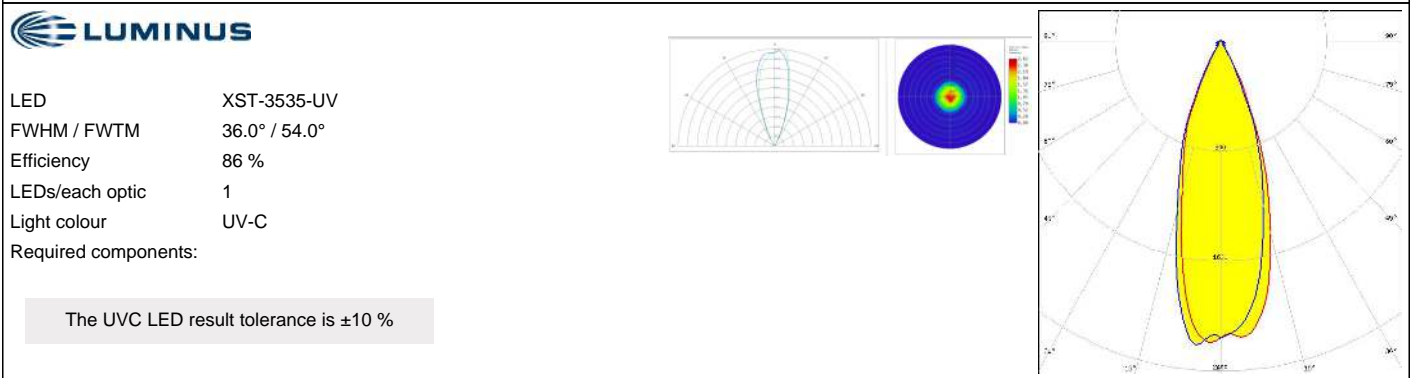

#### OPTICAL RESULTS (SIMULATED):

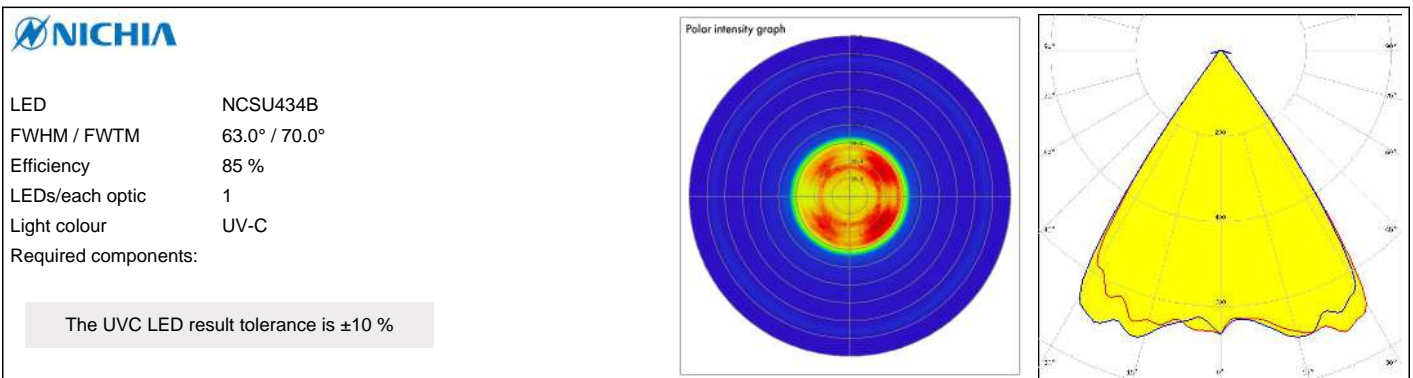
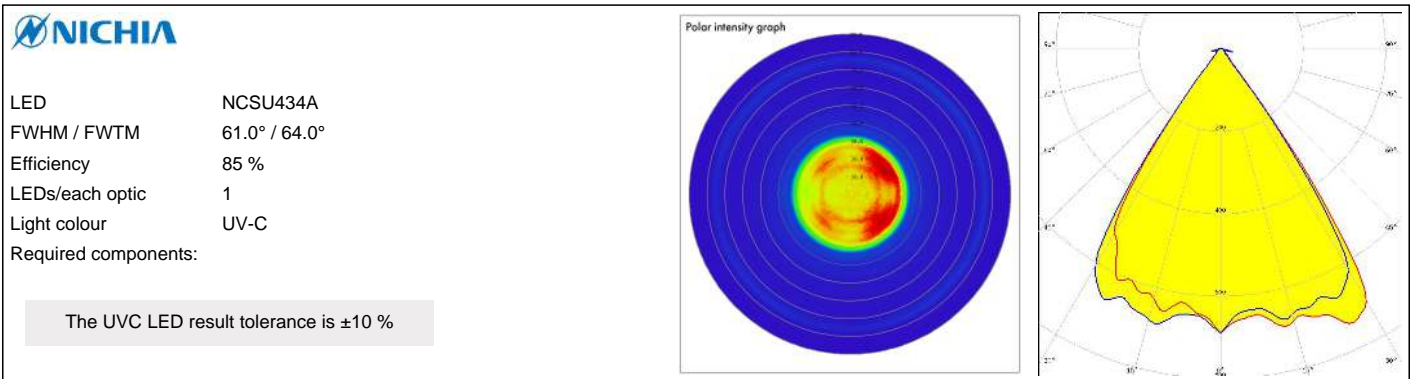
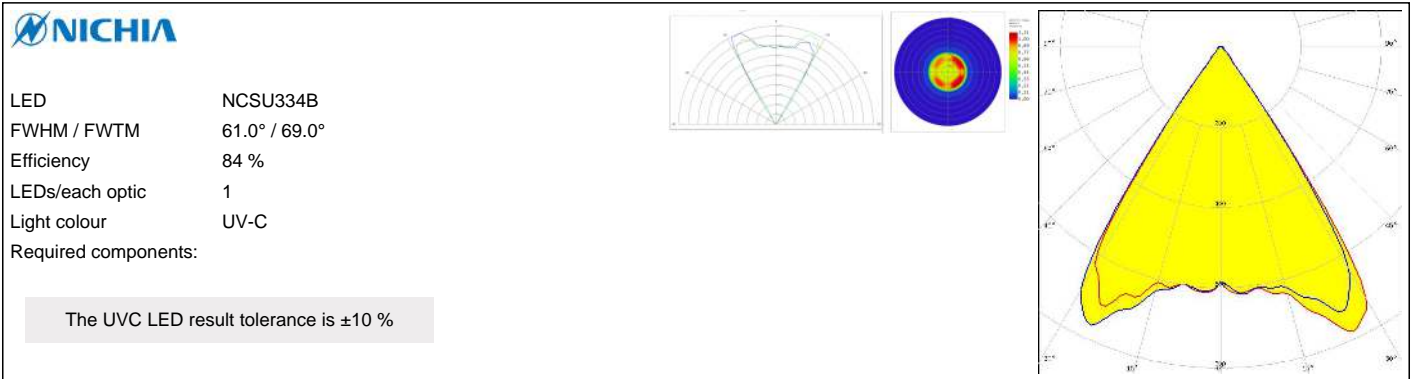

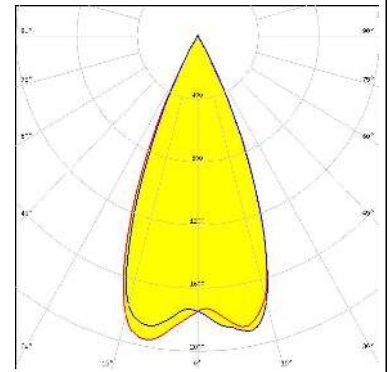
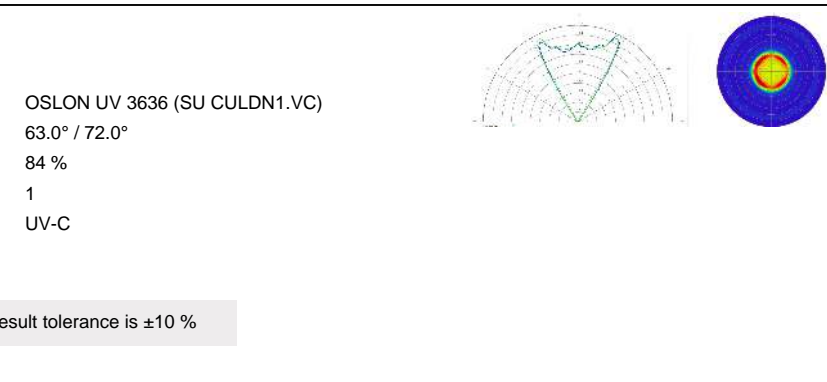
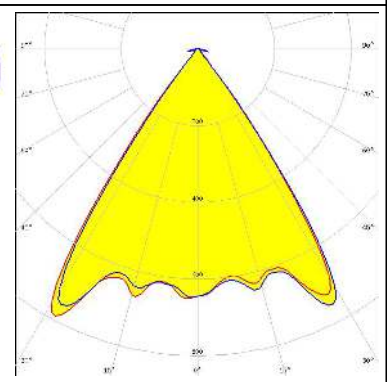

### OPTICAL RESULTS (SIMULATED):

<p><b>NICHIA</b></p> <p>LED: NVSU233B-D4            FWHM / FWTM: 45.0° / 58.0°            Efficiency: 97 %            Peak intensity: 2.1 cd/lm            LEDs/each optic: 1            Light colour: UV-A            Required components:</p>		
<p><b>OSRAM</b> Opto Semiconductors</p> <p>LED: OSLOM UV 3636 (SU CULDN1.VC)            FWHM / FWTM: 63.0° / 72.0°            Efficiency: 84 %            LEDs/each optic: 1            Light colour: UV-C            Required components:</p>		

The UVC LED result tolerance is ±10 %

### GENERAL INFORMATION:

NOTE: The typical beam angle will be changed by different color, chip size and chip position tolerance. The typical total beam angle is the full angle measured where the luminous intensity is half of the peak value.

### MATERIALS:

As part of our continuous research and improvement processes, and to ensure the best possible quality and availability of our products, LEDiL reserves the right to change material grades without notice.

### PRODUCT DATA USER AGREEMENT AND DISCLAIMER:

The measured data in the provided downloadable LEDiL Product Datasheets and Mechanical 2D-Drawings is rounded and provided as reference for planning. LEDiL Oy's optical specifications have been verified by conducting performance testing of the products in accordance with the company's quality system. The reported data are averaged results of multiple measurements with typical variation. LEDiL Oy reserves the right to without prior notification make changes and improvements to its products.

LEDiL Oy assumes neither warranty, nor guarantee nor any other liability of any kind for the contents and correctness of the provided data. The provided data has been generated with highest diligence but the provided data may in reality not represent the complete possible variation range of all intrinsic parameters. Therefore, in certain cases a deviation from the provided data could occur.

LEDiL Oy reserves the right to undertake technical changes of its products without further notification which could lead to changes in the provided data. LEDiL Oy assumes no liability of any kind for the possible deviation from any provided data or any other damage resulting from the usage of the provided data.

The user agrees to this disclaimer and user agreement with the download or usage of the provided files.

#### LEDiL Oy

Joensuunkatu 13  
FI-24240 SALO  
Finland

#### LEDiL Inc.

228 West Page Street  
Suite D  
Sycamore IL 60178  
USA

#### Ledil Optics Technology (Shenzhen) Co., Ltd.

# 405 , Block B  
Casic Motor Building  
Shenzhen 518057  
P.R.CHINA

#### Local sales and technical support

[www.ledil.com/  
where\\_to\\_buy](http://www.ledil.com/where_to_buy)

#### Shipping locations

Salo, Finland  
Hong Kong, China

#### Distribution Partners

[www.ledil.com/  
where\\_to\\_buy](http://www.ledil.com/where_to_buy)