

PKU 4800C Series DC-DC Converters
 Input 36-75 V, Output up to 7 A / 86 W

28701-BMR67103 Rev.E

Feb 2020

© Flex

Key Features

- Industry standard Sixteenth-brick
33.02 x 22.86 x 9.6 mm (1.30 x 0.90 x 0.38 in)
- High efficiency, typ. 90.6 % at 12 Vout half load
- 2250 Vdc input to output isolation
- Pre-bias start up
- Adjustable output voltage
- Support two modules operation in parallel
- Open frame intended for conducted cooling (cold wall)
- Meets safety requirements according to IEC/EN/UL 60950-1
- MTBF 5.2 Mh



General Characteristics

- Input under voltage shutdown
- Monotonic start-up
- Remote control
- Output over voltage protection
- Over temperature protection
- Output short-circuit protection
- Highly automated manufacturing ensures quality
- ISO 9001/14001 certified supplier

Safety Approvals



Design for Environment



Meets requirements in high-temperature lead-free soldering processes.

Contents

Ordering Information	2
General Information	2
Safety Specification	3
Absolute Maximum Ratings	4
Electrical Specification	
12 V, 7 A / 84 W	PKU 4813C PI 5
15 V, 5.7 A / 86 W	PKU 4815C PI 9
EMC Specification	13
Operating Information	14
Thermal Consideration	16
Connections	17
Mechanical Information	18
Soldering Information	21
Delivery Information	22
Product Qualification Specification	23

PKU 4800C Series DC-DC Converters
 Input 36-75 V, Output up to 7 A / 86 W

28701-BMR67103 Rev.E

Feb 2020

© Flex

Ordering Information

Product program	Output
PKU 4813 C	12 V, 7.0 A / 84 W
PKU 4815 C	15 V, 5.7 A / 86 W

Product number and Packaging

PKU 4XXXX n ₁ n ₂ n ₃ n ₄				
Options	n ₁	n ₂	n ₃	n ₄
Mounting	X			
Remote Control logic		X		
Lead length			X	
Delivery package information				X

Options	Description
n ₁	SI Surface mount PI Through hole
n ₂	Negative * P Positive
n ₃	5.30 mm * LA 3.69 mm (pin-cut) LB 4.57 mm (pin-cut) LC 2.79 mm (pin-cut)
n ₄	/B Tray /C Tape and Reel

Example: an open frame, surface mounted, negative logic 12V product with tray package would be PKU 4813C SI/B

* Standard variant (i.e. no option selected).

General Information
Reliability

The failure rate (λ) and mean time between failures (MTBF = $1/\lambda$) is calculated at max output power and an operating ambient temperature (T_A) of +40°C. Flex Power Modules uses Telcordia SR-332 Issue 2 Method 1 to calculate the mean steady-state failure rate and standard deviation (σ).

Telcordia SR-332 Issue 2 also provides techniques to estimate the upper confidence levels of failure rates based on the mean and standard deviation.

Mean steady-state failure rate, λ	Std. deviation, σ
193 nFailures/h	27 nFailures/h

MTBF (mean value) for the PKU 4000C series = 5.18 Mh.
 MTBF at 90% confidence level = 4.38 Mh

Compatibility with RoHS requirements

The products are compatible with the relevant clauses and requirements of the RoHS directive 2011/65/EU and have a

maximum concentration value of 0.1% by weight in homogeneous materials for lead, mercury, hexavalent chromium, PBB and PBDE and of 0.01% by weight in homogeneous materials for cadmium.

Exemptions in the RoHS directive utilized in Flex Power Modules products are found in the Statement of Compliance document.

Flex Power Modules fulfills and will continuously fulfill all its obligations under regulation (EC) No 1907/2006 concerning the registration, evaluation, authorization and restriction of chemicals (REACH) as they enter into force and is through product materials declarations preparing for the obligations to communicate information on substances in the products.

Quality Statement

The products are designed and manufactured in an industrial environment where quality systems and methods like ISO 9000, Six Sigma, and SPC are intensively in use to boost the continuous improvements strategy. Infant mortality or early failures in the products are screened out and they are subjected to an ATE-based final test. Conservative design rules, design reviews and product qualifications, plus the high competence of an engaged work force, contribute to the high quality of the products.

Warranty

Warranty period and conditions are defined in Flex Power Modules General Terms and Conditions of Sale.

Limitation of Liability

Flex Power Modules does not make any other warranties, expressed or implied including any warranty of merchantability or fitness for a particular purpose (including, but not limited to, use in life support applications, where malfunctions of product can cause injury to a person's health or life).

© Flex 2017

The information and specifications in this technical specification is believed to be correct at the time of publication. However, no liability is accepted for inaccuracies, printing errors or for any consequences thereof. Flex reserves the right to change the contents of this technical specification at any time without prior notice.

PKU 4800C Series DC-DC Converters
Input 36-75 V, Output up to 7 A / 86 W

28701-BMR67103 Rev.E

Feb 2020

© Flex

Safety Specification

General information

Flex Power Modules DC/DC converters and DC/DC regulators are designed in accordance with safety standards IEC/EN/UL60950, *Safety of Information Technology Equipment*.

IEC/EN/UL60950 contains requirements to prevent injury or damage due to the following hazards:

- Electrical shock
- Energy hazards
- Fire
- Mechanical and heat hazards
- Radiation hazards
- Chemical hazards

On-board DC-DC converters and DC/DC regulators are defined as component power supplies. As components they cannot fully comply with the provisions of any Safety requirements without "Conditions of Acceptability". Clearance between conductors and between conductive parts of the component power supply and conductors on the board in the final product must meet the applicable Safety requirements. Certain conditions of acceptability apply for component power supplies with limited stand-off (see Mechanical Information for further information). It is the responsibility of the installer to ensure that the final product housing these components complies with the requirements of all applicable Safety standards and Directives for the final product.

Component power supplies for general use should comply with the requirements in IEC/EN/UL 60950-1 *Safety of Information Technology Equipment*. Product related standards, e.g. IEEE 802.3af *Power over Ethernet*, and ETS-300132-2 *Power interface at the input to telecom equipment, operated by direct current (dc)* are based on IEC/EN/UL 60950-1 with regards to safety.

Flex Power Modules DC/DC converters, Power interface modules and DC/DC regulators are UL 60950-1 recognized and certified in accordance with EN 60950-1. The flammability rating for all construction parts of the products meet requirements for V-0 class material according to IEC 60695-11-10, *Fire hazard testing, test flames – 50 W* horizontal and vertical flame test methods.

Isolated DC/DC converters

The product may provide basic or functional insulation between input and output according to IEC/EN/UL 60950-1 (see Safety Certificate), different conditions shall be met if the output of a basic or a functional insulated product shall be considered as safety extra low voltage (SELV).

For basic insulated products (see Safety Certificate) the output is considered as safety extra low voltage (SELV) if one of the following conditions is met:

- The input source provides supplementary or double or reinforced insulation from the AC mains according to IEC/EN/UL 60950-1.
- The input source provides functional or basic insulation from the AC mains and the product's output is reliably connected to protective earth according to IEC/EN/UL 60950-1.

For functional insulated products (see Safety Certificate) the output is considered as safety extra low voltage (SELV) if one of the following conditions is met:

- The input source provides double or reinforced insulation from the AC mains according to IEC/EN/UL 60950-1.
- The input source provides basic or supplementary insulation from the AC mains and the product's output is reliably connected to protective earth according to IEC/EN/UL 60950-1.
- The input source is reliably connected to protective earth and provides basic or supplementary insulation according to IEC/EN/UL 60950-1 and the maximum input source voltage is 60 Vdc.

Galvanic isolation between input and output is verified in an electric strength test and the isolation voltage (V_{iso}) meets the voltage strength requirement for basic insulation according to IEC/EN/UL 60950-1.

It is recommended to use a slow blow fuse at the input of each DC/DC converter. If an input filter is used in the circuit the fuse should be placed in front of the input filter. In the rare event of a component problem that imposes a short circuit on the input source, this fuse will provide the following functions:

- Isolate the fault from the input power source so as not to affect the operation of other parts of the system
- Protect the distribution wiring from excessive current and power loss thus preventing hazardous overheating

PKU 4800C Series DC-DC Converters
 Input 36-75 V, Output up to 7 A / 86 W

28701-BMR67103 Rev.E

Feb 2020

© Flex

Absolute Maximum Ratings

Characteristics		min	typ	max	Unit
T_{P1}	Operating Temperature (see Thermal Consideration section)	-40		+125	°C
T_S	Storage temperature	-55		+125	°C
V_I	Input voltage	-0.5		+80	V
C_I	External input capacitance	47			μF
V_{iso}	Isolation voltage (input to output test voltage)			2250	Vdc
V_{tr}	Input voltage transient according to ETSI EN 300 132-2 and Telcordia GR-1089-CORE			100	V
V_{RC}	Remote Control pin voltage (see Operating Information section)	Positive logic option		6	V
		Negative logic option	-0.5	6	V
V_{adj}	Adjust pin voltage (see Operating Information section)	-0.5		5	V

Stresses above those listed under Absolute Maximum Ratings may cause permanent damage to the device. This is a stress rating only; functional operation of the device at these or any other conditions above those indicated in the Electrical Specification section of this specification is not implied. Exposure to absolute maximum rating conditions for extended periods may affect device reliability.

Fundamental Circuit Diagram

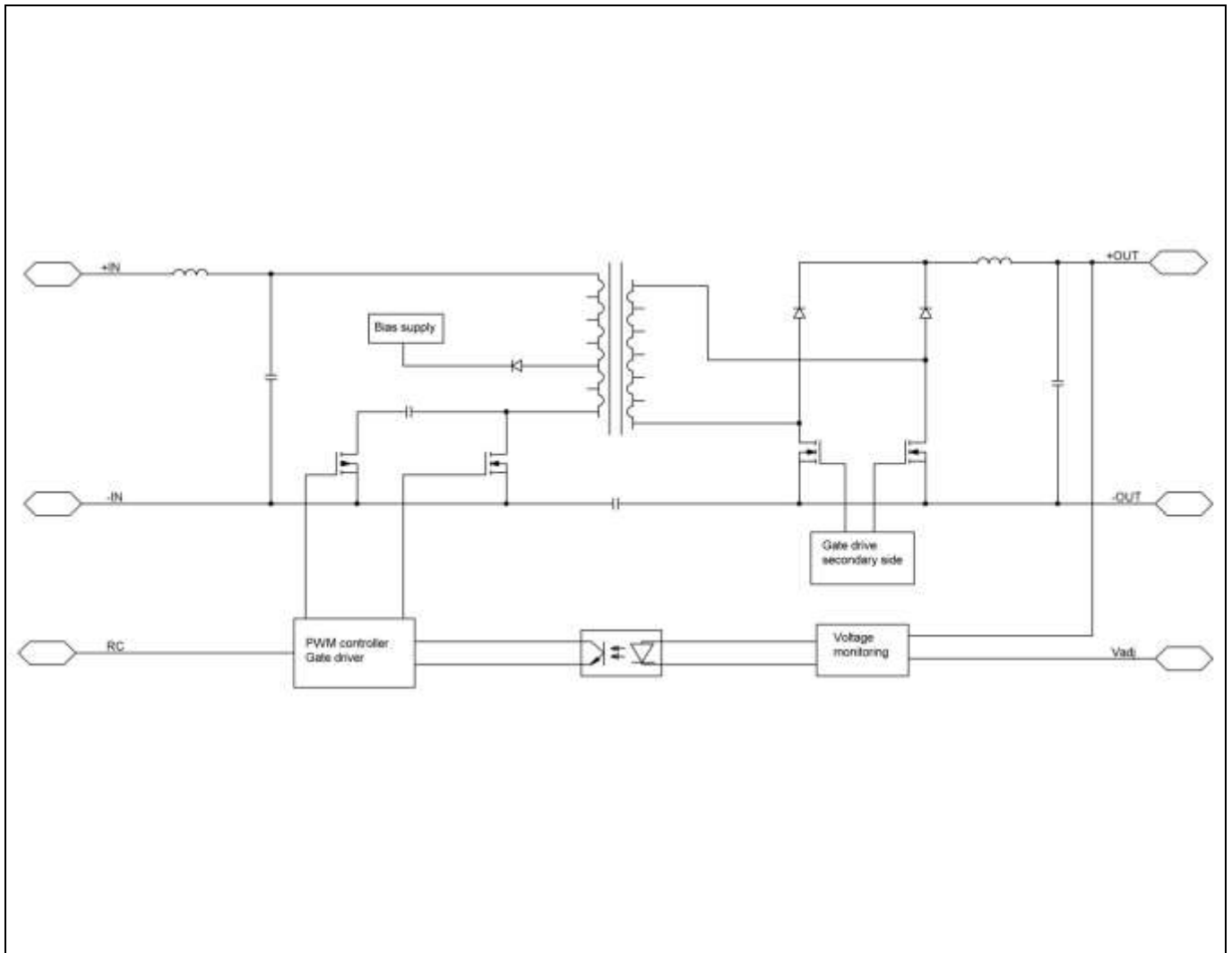

PKU 4800C Series DC-DC Converters
 Input 36-75 V, Output up to 7 A / 86 W

28701-BMR67103 Rev.E

Feb 2020

© Flex

Electrical Specification
12 V, 7.0 A / 84 W
PKU4813C
 $T_{P1} = -40$ to $+95^{\circ}\text{C}$, $V_I = 36$ to 75 V, unless otherwise specified under Conditions.

 Typical values given at: $T_{P1} = +25^{\circ}\text{C}$, $V_I = 53$ V, I_O max, unless otherwise specified under Conditions.

 Additional $C_{in} = 47 \mu\text{F}$, $C_{out} = 100\mu\text{F}$. See Operating Information section for selection of capacitor types.

Characteristics		Conditions	min	typ	max	Unit
V_I	Input voltage range		36		75	V
V_{loff}	Turn-off input voltage	Decreasing input voltage	31	32	33	V
V_{lon}	Turn-on input voltage	Increasing input voltage	34	35	36	V
C_I	Internal input capacitance			5		μF
P_O	Output power		0.9		84	W
η	Efficiency	50% of max I_O		90.5		%
		max I_O		90.6		
		50% of max I_O , $V_I = 48$ V		90.6		
		max I_O , $V_I = 48$ V		90.6		
P_d	Power Dissipation	max I_O		8.7	10.5	W
P_{li}	Input idling power	$I_O = 0$ A, $V_I = 53$ V		1.8		W
P_{RC}	Input standby power	$V_I = 53$ V (turned off with RC)		0.28		W
f_s	Switching frequency	0-100 % of max I_O	370	415	460	kHz

V_{Oi}	Output voltage initial setting and accuracy	$T_{P1} = +25^{\circ}\text{C}$, $V_I = 53$ V, $I_O = 7.0$ A	11.7	12	12.3	V
V_O	Output adjust range	See operating information	9.6		13.2	V
	Output voltage tolerance band	1-100% of max I_O	11.64		12.36	V
	Idling voltage	$I_O = 0$ A	11.7		20	V
	Line regulation	max I_O		5	20	mV
	Load regulation	$V_I = 53$ V, 1-100% of max I_O		6	20	mV
V_{tr}	Load transient voltage deviation	$V_I = 53$ V, Load step 25-75-25% of max I_O , $di/dt = 1$ A/ μs , $C_O = 1.5\text{mF}$		600	1000	mV
t_{tr}	Load transient recovery time			1	1.6	ms
t_r	Ramp-up time (from 10-90% of V_{Oi})	10-100% of max I_O		10	13	ms
t_s	Start-up time (from V_I connection to 90% of V_{Oi})			13	16	ms
t_{RC}	RC start-up time (from V_{RC} connection to 90% of V_{Oi})	max I_O		125	160	ms
RC	Sink current	See operating information, Note 1	0.25			mA
	Trigger level	Decreasing / Increasing RC-voltage		1.39 / 1.44		V
I_O	Output current	See note 2	0.07		7.0	A
I_{lim}	Current limit threshold	$T_{P1} < \text{max } T_{P1}$	7.5	11	13	A
I_{sc}	Short circuit current	$T_{P1} = 25^{\circ}\text{C}$, hic-up mode		7		A
C_{out}	Recommended Capacitive Load	$T_{P1} = 25^{\circ}\text{C}$, see Note 3	100		1500	μF
V_{Oac}	Output ripple & noise	See ripple & noise section, V_{Oi}		20	60	mVp-p
OVP	Over voltage protection	$T_{P1} = +25^{\circ}\text{C}$, $V_I = 53$ V, 1-100% of max I_O		16		V

Note 1: Sink current drawn by external device connected to the RC pin.

Note 2: Minimum 0.9W load is required to guaranty line and load regulation

Note 3: Low ESR value

PKU 4800C Series DC-DC Converters
 Input 36-75 V, Output up to 7 A / 86 W

28701-BMR67103 Rev.E

Feb 2020

© Flex

Typical Characteristics
 12 V, 7.0 A / 84 W

PKU4813C

Efficiency

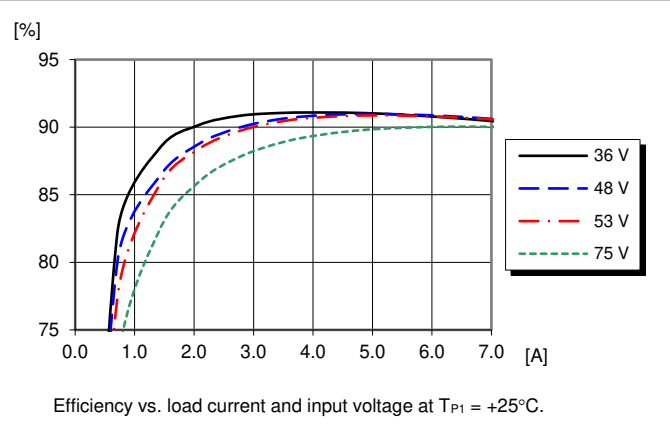

Power Dissipation

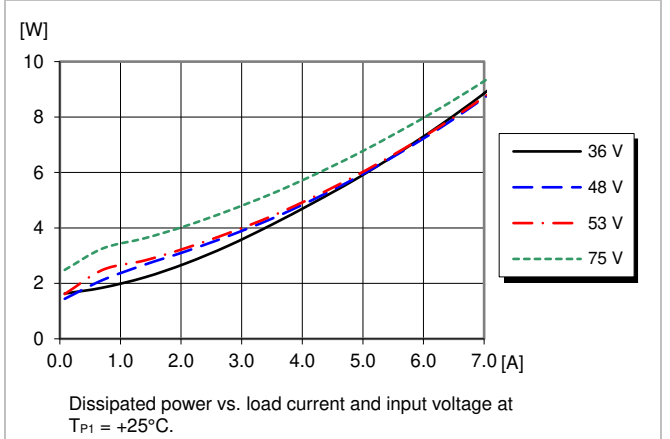

Output Characteristics

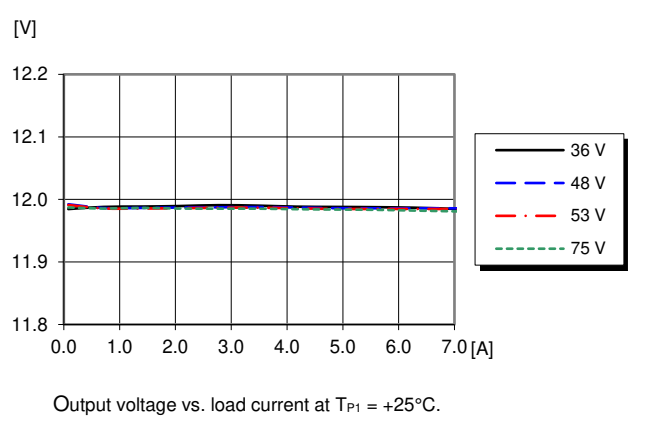

Current Limit Characteristics

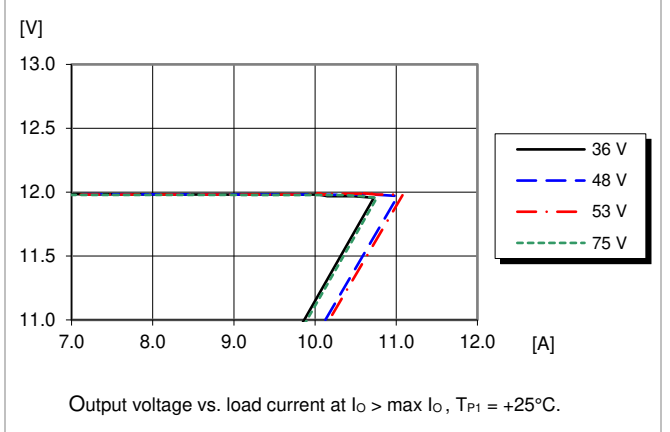

Output Characteristics at light load

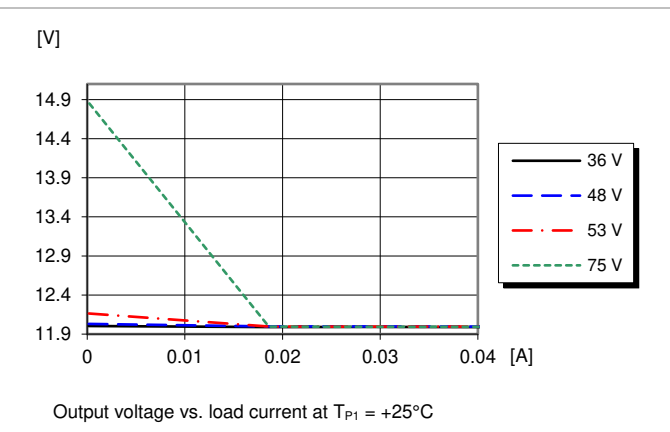

PKU 4800C Series DC-DC Converters
 Input 36-75 V, Output up to 7 A / 86 W

28701-BMR67103 Rev.E

Feb 2020

© Flex

Typical Characteristics

12 V, 7.0 A / 84 W

PKU4813C

Start-up

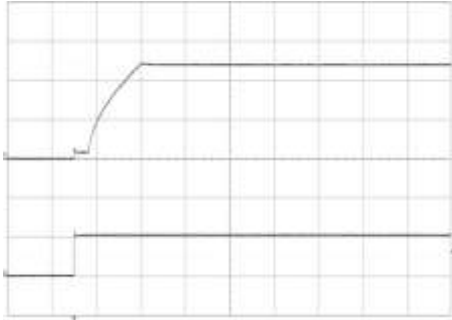

Start-up enabled by connecting V_1 at:
 $T_{P1} = +25^\circ\text{C}$, $V_1 = 53\text{ V}$,
 $I_o = 7.0\text{ A}$ resistive load.

Top trace: Output voltage (5 V/div.),
 Bottom trace: Input voltage (50 V/div.).
 Time scale: (10 ms/div.).

Shut-down

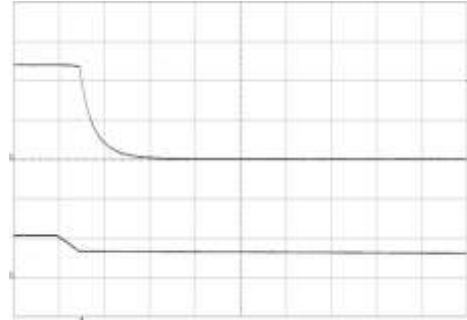

Shut-down enabled by disconnecting V_1 at:
 $T_{P1} = +25^\circ\text{C}$, $V_1 = 53\text{ V}$,
 $I_o = 7.0\text{ A}$ resistive load.

Top trace: Output voltage (5 V/div.),
 Bottom trace: Input voltage (50 V/div.).
 Time scale: (1 ms/div.).

Output Ripple & Noise

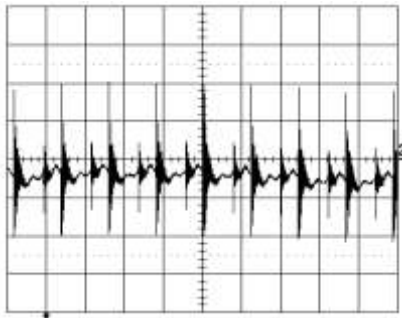

Output voltage ripple at:
 $T_{P1} = +25^\circ\text{C}$, $V_1 = 53\text{ V}$,
 $I_o = 7.0\text{ A}$ resistive load.

Trace: output voltage (5 mV/div.).
 Time scale: (2 μs /div.).
 20 MHz bandwidth filter 10 μF +0.1 μF

Output Load Transient Response

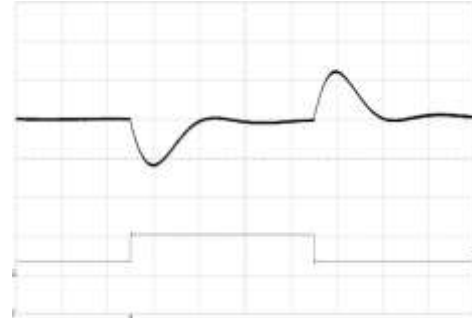

Output voltage response to load current step-change (1.75 – 5.25 – 1.75 A) at: $C_o = 1.5\text{mF}$,
 $T_{P1} = +25^\circ\text{C}$, $V_1 = 53\text{ V}$.

Top trace: Output voltage (0.5 V/div.).
 Bottom trace: Load current (5 A/div.).
 Time scale: (1 ms/div.).

Output Voltage Adjust (see operating information)

Passive adjust

The resistor value for an adjusted output voltage is calculated by using the following equations:

Output Voltage Adjust Upwards, Increase:

$$R_{adj} = 5.11 \times \left(\frac{12(100 + \Delta\%)}{1.225 \times \Delta\%} - \frac{(100 + 2 \times \Delta\%)}{\Delta\%} \right) \text{ k}\Omega$$

Example: Increase 4% $\Rightarrow V_{out} = 12.48\text{ Vdc}$

$$5.11 \times \left(\frac{12(100 + 4)}{1.225 \times 4} - \frac{(100 + 2 \times 4)}{4} \right) \text{ k}\Omega = 1164 \text{ k}\Omega$$

Output Voltage Adjust Downwards, Decrease:

$$R_{adj} = 5.11 \times \left(\frac{100}{\Delta\%} - 2 \right) \text{ k}\Omega$$

Example: Decrease 2% $\Rightarrow V_{out} = 11.76\text{ Vdc}$

$$5.11 \times \left(\frac{100}{2} - 2 \right) \text{ k}\Omega = 245 \text{ k}\Omega$$

PKU 4800C Series DC-DC Converters
 Input 36-75 V, Output up to 7 A / 86 W

28701-BMR67103 Rev.E

Feb 2020

© Flex

Typical Characteristics
12 V, 7.0 A / 84 W

PKU4813C

Output Current Derating – Open frame

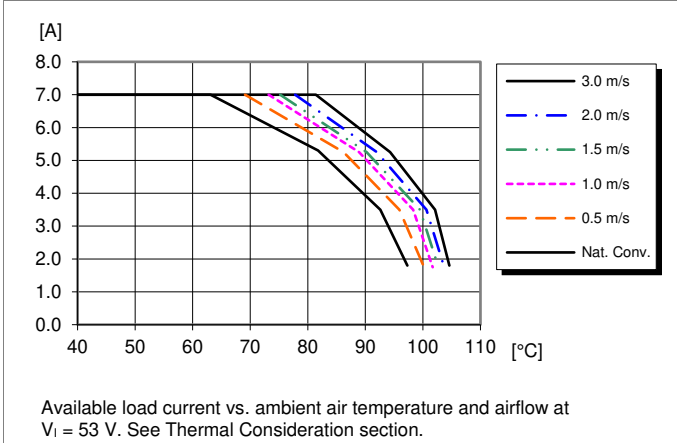

Output Current Derating – Cold wall sealed box

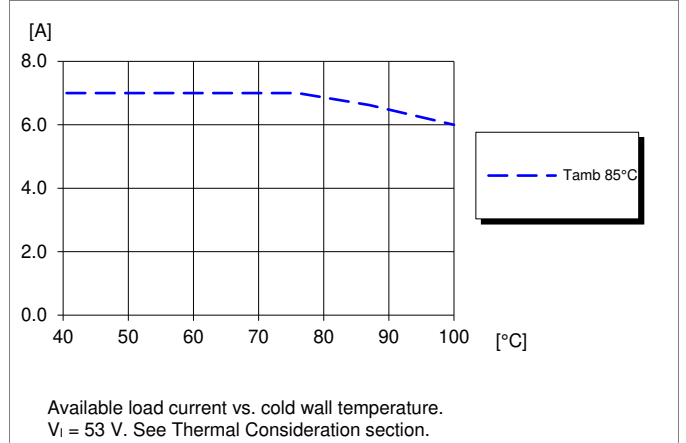

PKU 4800C Series DC-DC Converters
Input 36-75 V, Output up to 7 A / 86 W

28701-BMR67103 Rev.E

Feb 2020

© Flex

Electrical Specification
15 V, 5.7 A / 86 W

PKU4815C

$T_{P1} = -40$ to $+95^{\circ}\text{C}$, $V_I = 36$ to 75 V, unless otherwise specified under Conditions.
Typical values given at: $T_{P1} = +25^{\circ}\text{C}$, $V_I = 53$ V, $I_O = \text{max}$, unless otherwise specified under Conditions.
Additional $C_{in} = 47 \mu\text{F}$, $C_{out} = 100\mu\text{F}$. See Operating Information section for selection of capacitor types.

Characteristics		Conditions	min	typ	max	Unit
V_I	Input voltage range		36		75	V
V_{loff}	Turn-off input voltage	Decreasing input voltage	31	32	33	V
V_{lon}	Turn-on input voltage	Increasing input voltage	34	35	36	V
C_I	Internal input capacitance			5		μF
P_O	Output power		0.9		86	W
η	Efficiency	50% of max I_O		90.3		%
		max I_O		91.6		
		50% of max I_O , $V_I = 48$ V		90.5		
		max I_O , $V_I = 48$ V		91.6		
P_d	Power Dissipation	max I_O		7.8	9.3	W
P_{li}	Input idling power	$I_O = 0$ A, $V_I = 53$ V		1.7		W
P_{RC}	Input standby power	$V_I = 53$ V (turned off with RC)		0.28		W
f_s	Switching frequency	0-100 % of max I_O	370	415	460	kHz

V_{Oi}	Output voltage initial setting and accuracy	$T_{P1} = +25^{\circ}\text{C}$, $V_I = 53$ V, $I_O = 5.7$ A	14.6	15	15.4	V
V_O	Output adjust range	See operating information	12		16.5	V
	Output voltage tolerance band	1-100% of max I_O	14.55		15.45	V
	Idling voltage	$I_O = 0$ A	14.6		20	V
	Line regulation	max I_O		5	15	mV
	Load regulation	$V_I = 53$ V, 1-100% of max I_O		10	30	mV
V_{tr}	Load transient voltage deviation	$V_I = 53$ V, Load step 25-75-25% of max I_O , $di/dt = 1$ A/ μs , $C_O = 0.8$ mF		600	1000	mV
t_{tr}	Load transient recovery time			0.5		ms
t_r	Ramp-up time (from 10-90% of V_{Oi})	10-100% of max I_O		9	15	ms
t_s	Start-up time (from V_I connection to 90% of V_{Oi})			13	16	ms
t_{RC}	RC start-up time (from V_{RC} connection to 90% of V_{Oi})	max I_O		115	160	ms
RC	Sink current	See operating information, Note 1	0.25			mA
	Trigger level	Decreasing / Increasing RC-voltage		1.39 / 1.44		V
I_O	Output current	See note 2	0.06		5.7	A
I_{lim}	Current limit threshold	$T_{P1} < \text{max } T_{P1}$	5.7	8.4	11	A
I_{sc}	Short circuit current	$T_{P1} = 25^{\circ}\text{C}$, hic-up mode		4.5		A
C_{out}	Recommended Capacitive Load	$T_{P1} = 25^{\circ}\text{C}$, see Note 3	100		1500	μF
V_{Oac}	Output ripple & noise	See ripple & noise section, V_{Oi}		30	60	mVp-p
OVP	Over voltage protection	$T_{P1} = +25^{\circ}\text{C}$, $V_I = 53$ V, 1-100% of max I_O		19		V

Note 1: Sink current drawn by external device connected to the RC pin.

Note 2: Minimum 0.9W load is required to guaranty line and load regulation

Note 3: Low ESR value

PKU 4800C Series DC-DC Converters
 Input 36-75 V, Output up to 7 A / 86 W

28701-BMR67103 Rev.E

Feb 2020

© Flex

Typical Characteristics
15 V, 5.7 A / 86 W

PKU4815C

Efficiency

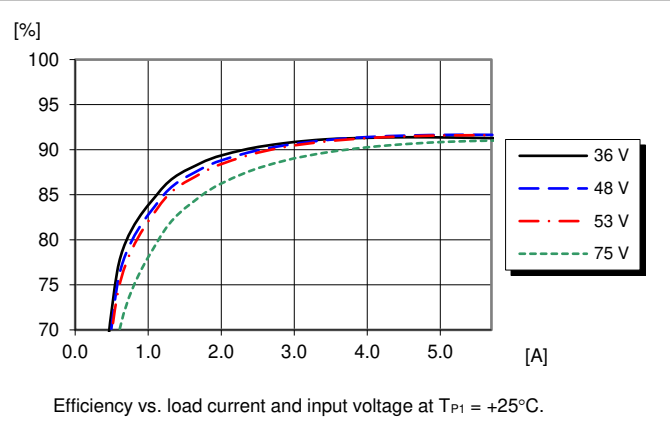

Power Dissipation

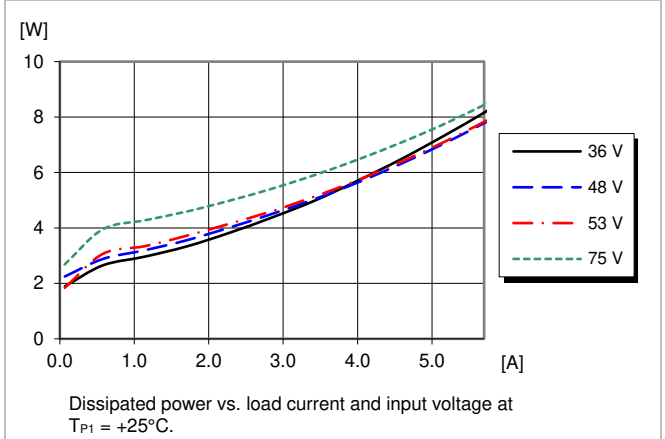

Output Characteristics

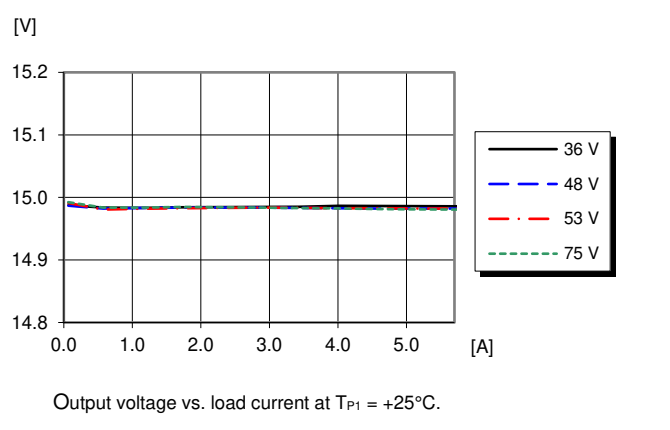

Current Limit Characteristics

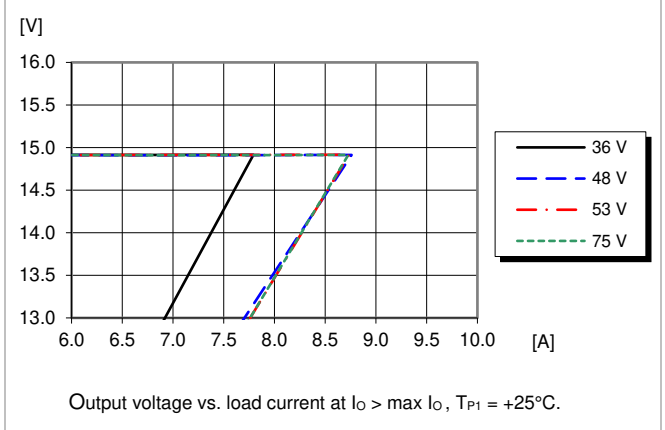

Output Characteristics at light load

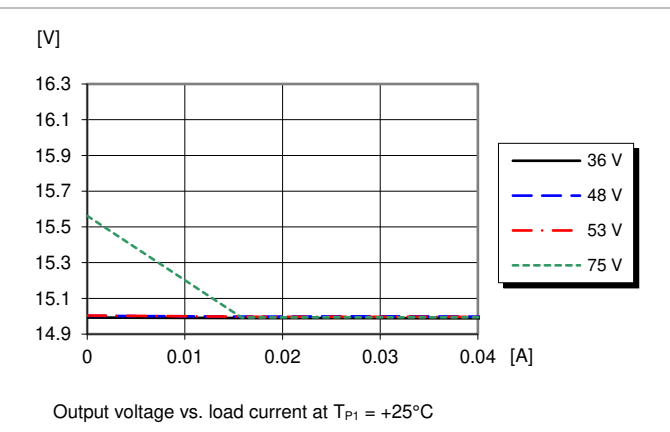

PKU 4800C Series DC-DC Converters
 Input 36-75 V, Output up to 7 A / 86 W

28701-BMR67103 Rev.E

Feb 2020

© Flex

Typical Characteristics

15 V, 5.7 A / 86 W

PKU4815C

Start-up

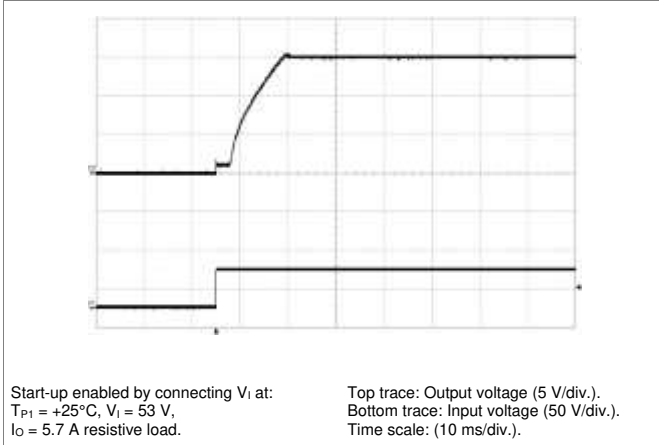

Shut-down

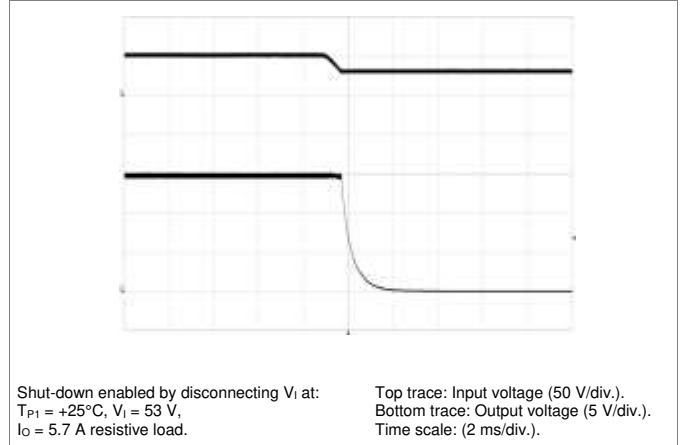

Output Ripple & Noise

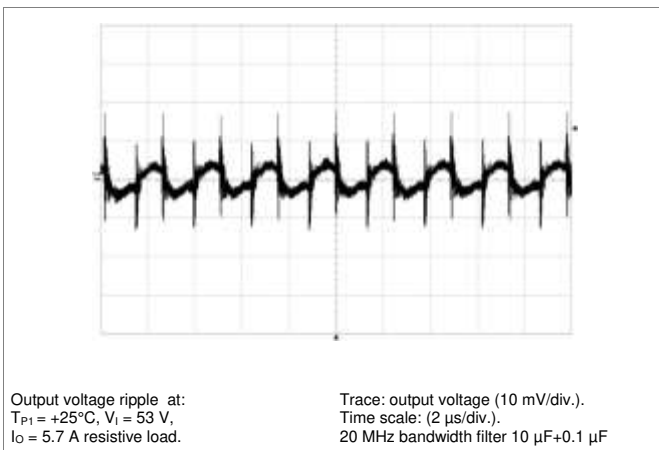

Output Load Transient Response

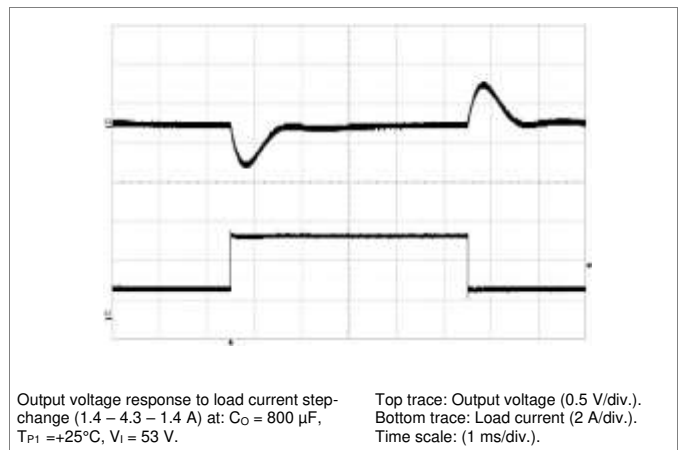

Output Voltage Adjust (see operating information)

Passive adjust

The resistor value for an adjusted output voltage is calculated by using the following equations:

Output Voltage Adjust Upwards, Increase:

$$R_{adj} = 5.11 \times \left(\frac{15(100 + \Delta\%)}{1.225 \times \Delta\%} - \frac{(100 + 2 \times \Delta\%)}{\Delta\%} \right) \text{ k}\Omega$$

Example: Increase 4% $\Rightarrow V_{out} = 15.6\text{ Vdc}$

$$5.11 \times \left(\frac{15(100 + 4)}{1.225 \times 4} - \frac{(100 + 2 \times 4)}{4} \right) \text{ k}\Omega = 1488 \text{ k}\Omega$$

Output Voltage Adjust Downwards, Decrease:

$$R_{adj} = 5.11 \times \left(\frac{100}{\Delta\%} - 2 \right) \text{ k}\Omega$$

Example: Decrease 2% $\Rightarrow V_{out} = 14.7\text{ Vdc}$

$$5.11 \times \left(\frac{100}{2} - 2 \right) \text{ k}\Omega = 245 \text{ k}\Omega$$

PKU 4800C Series DC-DC Converters
 Input 36-75 V, Output up to 7 A / 86 W

28701-BMR67103 Rev.E

Feb 2020

© Flex

Typical Characteristics
15 V, 5.7 A / 86 W

PKU4815C

Output Current Derating – Open frame

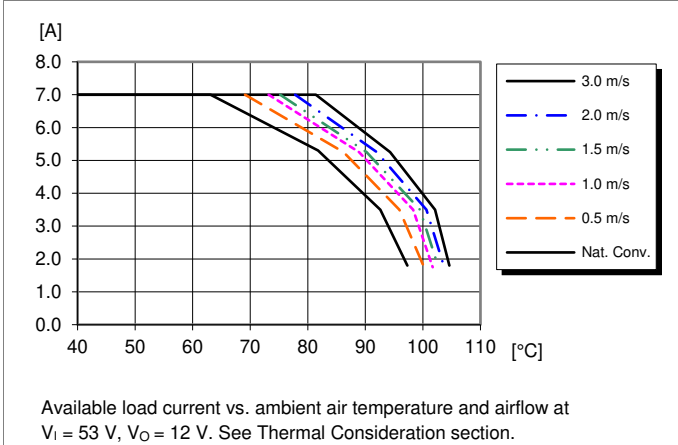

Output Current Derating – Cold wall sealed box

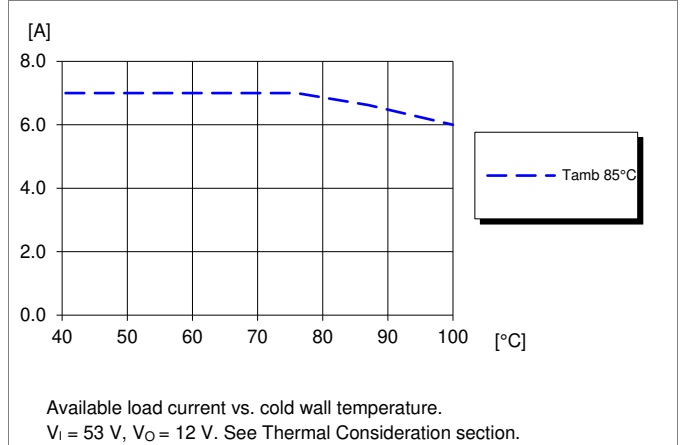

PKU 4800C Series DC-DC Converters
 Input 36-75 V, Output up to 7 A / 86 W

28701-BMR67103 Rev.E

Feb 2020

© Flex

EMC Specification

Conducted EMI measured according to EN55022, CISPR 22 and FCC part 15J (see test set-up). See Design Note 009 for further information. The fundamental switching frequency is 415 kHz for PKU 4813C. The EMI characteristics below is measured at $V_I = 53\text{ V}$ and max I_O .

Conducted EMI Input terminal value (typ)

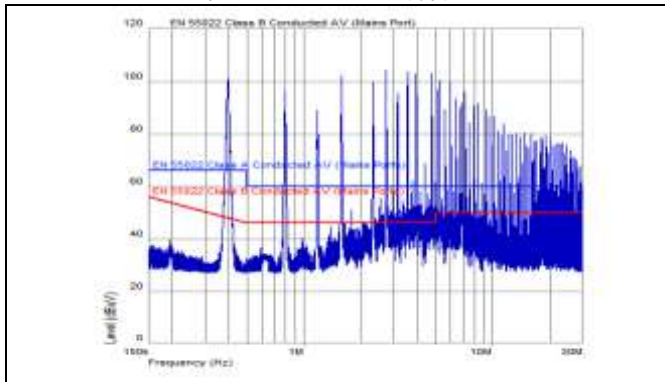

EMI without filter

Optional external filter for class B

Suggested external input filter in order to meet class B in EN 55022, CISPR 22 and FCC part 15J. Filter optimized for minimum PWB area.

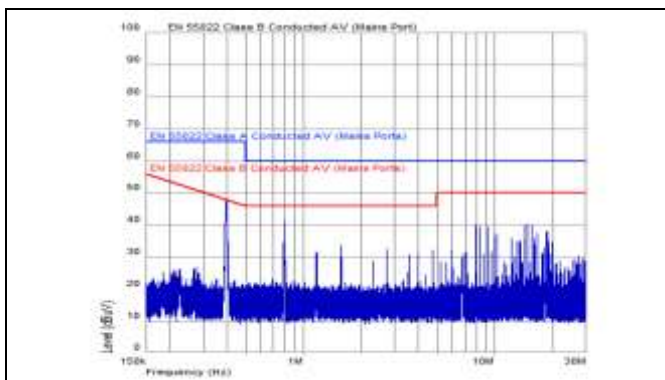
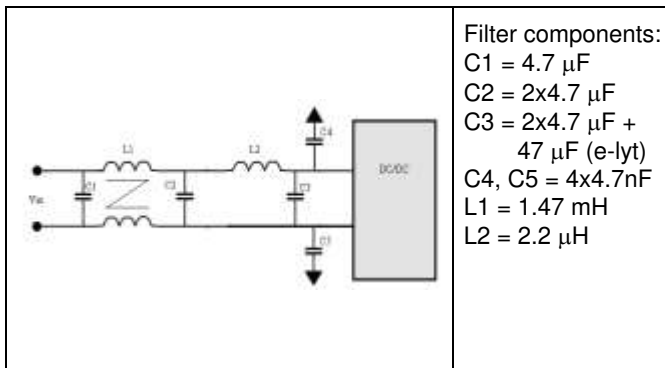

EMI with filter

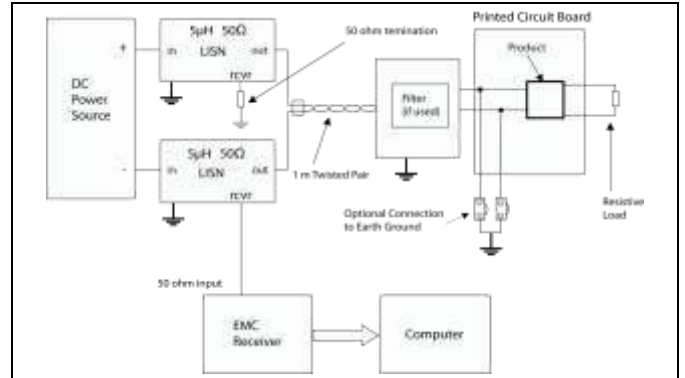

Test set-up

Layout recommendations

The radiated EMI performance of the product will depend on the PWB layout and ground layer design. It is also important to consider the stand-off of the product. If a ground layer is used, it should be connected to the output of the product and the equipment ground or chassis.

A ground layer will increase the stray capacitance in the PWB and improve the high frequency EMC performance.

Output ripple and noise

Output ripple and noise is measured according to figure below. See Design Note 022 for detailed information.

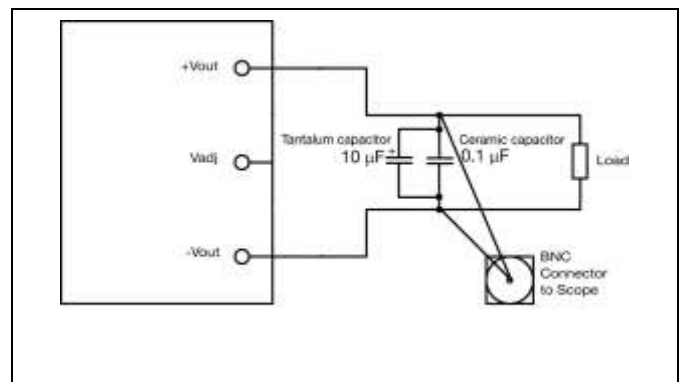

Output ripple and noise test setup

PKU 4800C Series DC-DC Converters Input 36-75 V, Output up to 7 A / 86 W	28701-BMR67103 Rev.E	Feb 2020
	© Flex	

Operating information

Input Voltage

The input voltage range 36 to 75 Vdc meets the requirements of the European Telecom Standard ETS 300 132-2 for normal input voltage range in -48 and -60 Vdc systems, -40.5 to -57.0 V and -50.0 to -72 V respectively.

At input voltages exceeding 75 V, the power loss will be higher than at normal input voltage and T_{P1} must be limited to absolute max +125°C. The absolute maximum continuous input voltage is 80 Vdc.

Short duration transient disturbances can occur on the DC distribution and input of the product when a short circuit fault occurs on the equipment side of a protective device (fuse or circuit breaker). The voltage level, duration and energy of the disturbance are dependant on the particular DC distribution network characteristics and can be sufficient to damage the product unless measures are taken to suppress or absorb this energy. The transient voltage can be limited by capacitors and other energy absorbing devices like Zener diodes connected across the positive and negative input conductors at a number of strategic points in the distribution network. The end-user must secure that the transient voltage will not exceed the value stated in the Absolute maximum ratings. ETSI TR 100 283 describes the parameters of DC distribution networks and provides guidelines for controlling the transient and reduce its harmful effect.

Turn-off Input Voltage

The products monitor the input voltage and will turn on and turn off at predetermined levels.

The minimum hysteresis between turn on and turn off input voltage is 1 V.

Remote Control (RC)

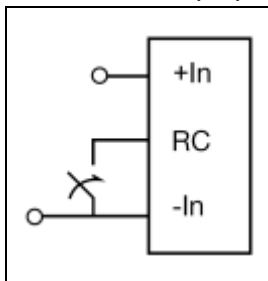

The products are fitted with a remote control function referenced to the primary negative input connection (-In), with negative and positive logic options available. The RC function allows the product to be turned on/off by an external device like a semiconductor or mechanical switch. The RC pin has an internal pull up resistor.

The external device must provide a minimum required sink current to guarantee a voltage not higher than maximum voltage on the RC pin (see Electrical characteristics table). When the RC pin is left open, the voltage generated on the RC pin is 4 - 5 V.

The standard product is provided with “negative logic” RC and will be off until the RC pin is connected to the -In. To turn off the product the RC pin should be left open, or connected to a voltage higher than 2 V referenced to -In. In situations where it is desired to have the product to power up automatically

without the need for control signals or a switch, the RC pin can be wired directly to -In.

The second option is “positive logic” remote control, which can be ordered by adding the suffix “P” to the end of the part number. When the RC pin is left open, the product starts up automatically when the input voltage is applied. Turn off is achieved by connecting the RC pin to the -In. The product will restart automatically when this connection is opened.

See Design Note 021 for detailed information.

Input and Output Impedance

The impedance of both the input source and the load will interact with the impedance of the product. It is important that the input source has low characteristic impedance. The source impedance, including the ESR value in the external capacitance shall be below 0.25Ω over the temperature range to prevent degradation of function and performance. The products are designed for stable operation with a minimum of 47 μ F external capacitance with low ESR value connected to the input. The electrolytic capacitors will be degraded in low temperature and the ESR value may increase. The needed input capacitance in low temperature should be equivalent to 47 μ F at 20° C. This means that the input capacitor value may need to be substantially larger to guarantee a stable input at low temperatures. The performance in some applications can be enhanced by addition of external capacitance as described under External Decoupling Capacitors.

External Decoupling Capacitors

When powering loads with significant dynamic current requirements, the voltage regulation at the point of load can be improved by addition of decoupling capacitors at the load. The most effective technique is to locate low ESR ceramic and electrolytic capacitors as close to the load as possible, using several parallel capacitors to lower the effective ESR. The ceramic capacitors will handle high-frequency dynamic load changes while the electrolytic capacitors are used to handle low frequency dynamic load changes. It is equally important to use low resistance and low inductance PWB layouts and cabling.

External decoupling capacitors will become part of the product’s control loop. The control loop is optimized for a wide range of external capacitance and the maximum and minimum recommended value that could be used without any additional analysis is found in the Electrical specification.

For further information please contact your local Flex Power Modules representative.

Output Voltage Adjust (V_{adj})

The products have an Output Voltage Adjust pin (V_{adj}). This pin can be used to adjust the output voltage above or below Output voltage initial setting.

When increasing the output voltage, the voltage at the output

PKU 4800C Series DC-DC Converters Input 36-75 V, Output up to 7 A / 86 W	28701-BMR67103 Rev.E Feb 2020
© Flex	

pins must be kept below the threshold of the over voltage protection, (OVP) to prevent the product from shutting down. At increased output voltages the maximum power rating of the product remains the same, and the max output current must be decreased correspondingly.

To increase the output voltage a resistor should be connected between the V_{adj} pin and +Out pin. The value of the adjust resistor should be calculated according to the formulas provided in the Electrical Specification section for the respective product.

To decrease the output voltage, the resistor should be connected between the V_{adj} pin and -Out pin.

Pre-bias Start-up

The product has a Pre-bias start up functionality and will not sink current during start up if a pre-bias load is present at the output terminals.

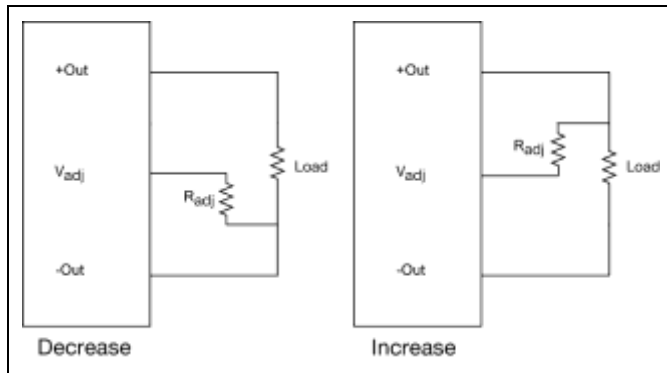

Parallel Operation

This product is not intended for load sharing. However two products may be paralleled for redundancy if the total power is equal or less than P_O max. No external circuits are needed.

See Design Note 006 for detailed information.

Over Temperature Protection (OTP)

The products are protected from thermal overload by an internal over temperature shutdown circuit.

When T_{P3} as defined in thermal consideration section exceeds 130°C the product will shut down. The product will make continuous attempts to start up (non-latching mode) and resume normal operation automatically when the temperature has dropped $>5^{\circ}\text{C}$ below the temperature threshold.

Over Voltage Protection (OVP)

The products have output over voltage protection that will shut down the product in over voltage conditions. The product will resume normal operation automatically after removal of the over voltage condition.

Over Current Protection (OCP)

The products include current limiting circuitry for protection at continuous overload. The OCP works in a hiccup mode and will make continuous attempts to start up and will resume normal operation automatically after removal of the over current condition. The load distribution should be designed for the maximum output short circuit current specified.

PKU 4800C Series DC-DC Converters
 Input 36-75 V, Output up to 7 A / 86 W

28701-BMR67103 Rev.E

Feb 2020

© Flex

Thermal Consideration

General

The products are designed to operate in different thermal environments and sufficient cooling must be provided to ensure reliable operation.

For products mounted on a PWB without a heat sink attached, cooling is achieved mainly by conduction, from the pins to the host board, and convection, which is dependant on the airflow across the product. Increased airflow enhances the cooling of the product. The Output Current Derating graph found in the Output section for each model provides the available output current vs. ambient air temperature and air velocity at $V_I = 48 V$.

The product is tested on a 254 x 254 mm, 35 μm (1 oz), 16-layer test board mounted vertically in a wind tunnel with a cross-section of 608 x 203 mm.

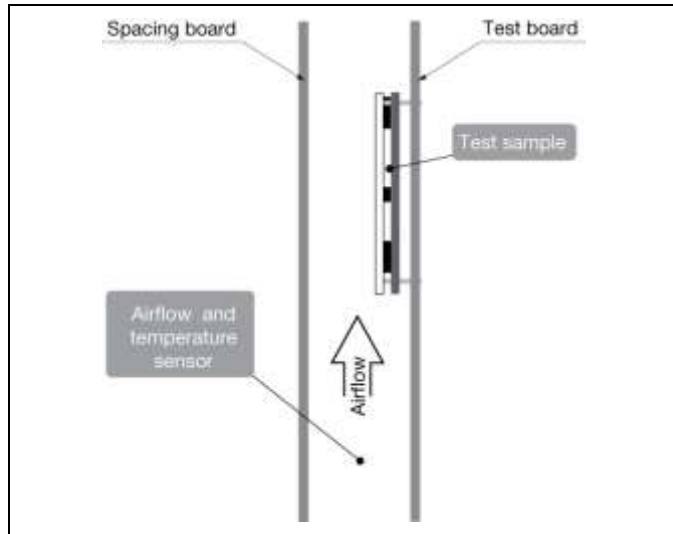

For products with gap-pad used in a sealed box/cold wall application, cooling is achieved mainly by conduction through the cold wall. The thermal performance can be optimized if a profiled cold wall and gap-pad is used. For detailed information check the mechanical drawings. The product performance has been tested in a sealed box presented in the figure below in combination with a gap-pad and profiled cold wall. The ambient temperature (inside the box) has been set to 85°C. The cold wall temperature varied. The Output Current Derating graphs are found in the Output section for each model. See Design Note 028 for further details.

Gap-pad between cold wall and module ferrites:
 Bergquist 5000S35, 2mm compressed to 1.2mm.
 Hardness shore (00) 35.
 Thermal conductivity 5.0 W/m-K

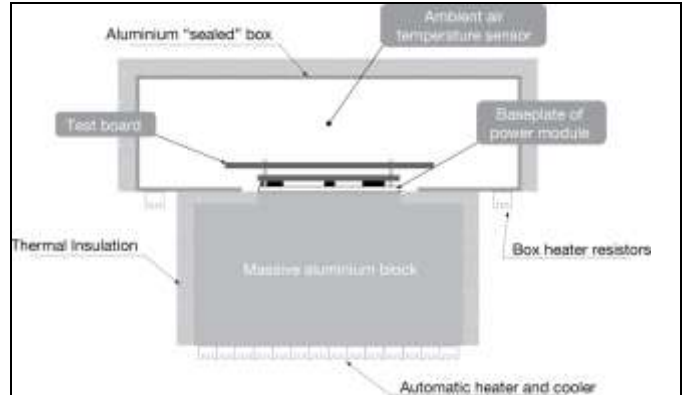

Definition of product operating temperature

The temperature at the positions (T_{P1} , T_{P2} , T_{P3} , T_{P4}) should not exceed the maximum temperatures in the table below. The number of measurement points may vary with different thermal design and applications. Temperatures above maximum measured at the reference point P1, P2, P3, P4 are not allowed and may cause permanent damage.

Position	Description	Max Temp.
P1	Reference point, Inductor	$T_{P1} = 125^\circ C$
P2	Mosfet case	$T_{P2} = 125^\circ C$
P3	Mosfet case	$T_{P3} = 125^\circ C$
P4	Diode	$T_{P4} = 125^\circ C$

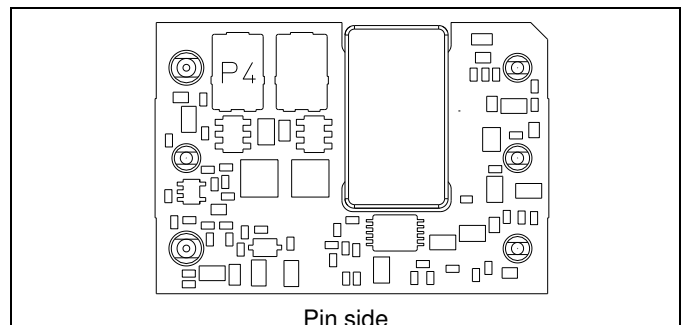
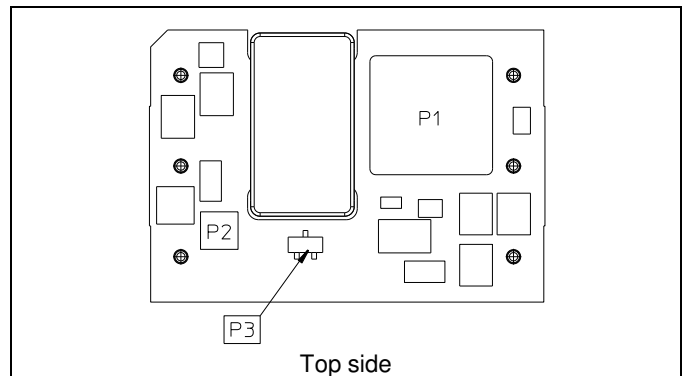

PKU 4800C Series DC-DC Converters
 Input 36-75 V, Output up to 7 A / 86 W

28701-BMR67103 Rev.E

Feb 2020

© Flex

Connections (top side)

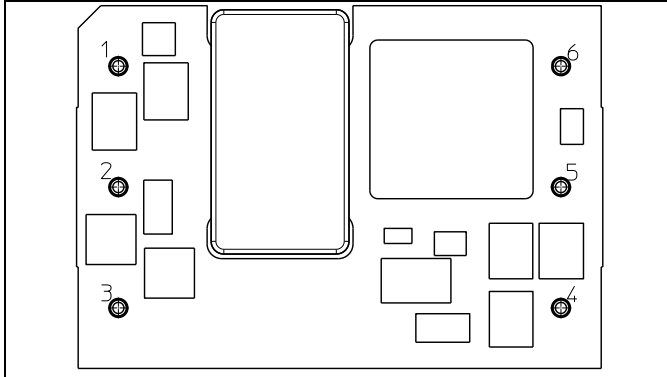

Pin	Designation	Function
1	+In	Positive input
2	RC	Remote control
3	-In	Negative input
4	-Out	Negative output
5	V _{adj}	Output voltage adjust
6	+Out	Positive output

PKU 4800C Series DC-DC Converters
 Input 36-75 V, Output up to 7 A / 86 W

28701-BMR67103 Rev.E

Feb 2020

© Flex

Mechanical Information - Surface Mount Version

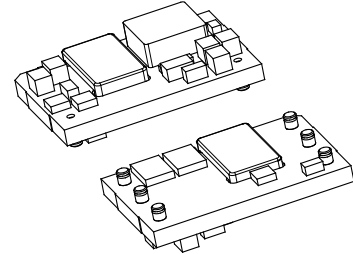
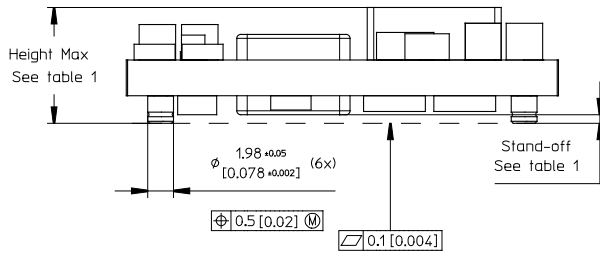

TOP VIEW

Pin positions according to recommended footprint

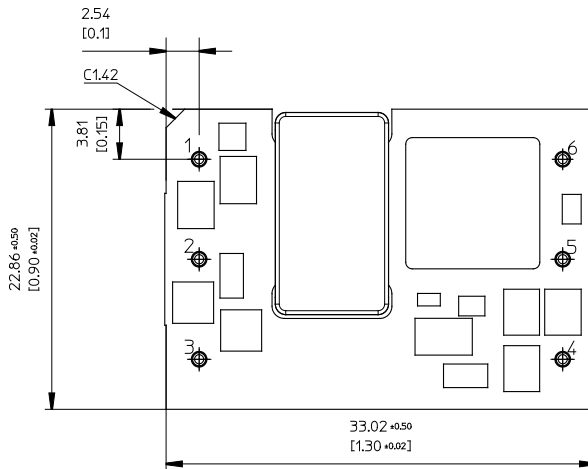

RECOMMENDED FOOTPRINT - TOP VIEW

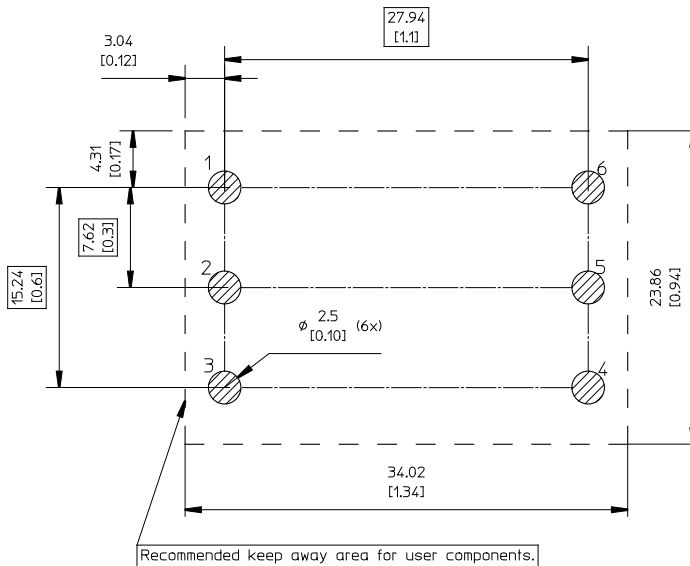

Table 1

	Product height	Stand-off
BMR671 03 (PKU4813C)	Max 9.6 [0.38]	Nominal 0.65 [0.03]
BMR671 06 (PKU4815C)	Max 10.2 [0.4]	Nominal 1.25 [0.049]

PIN SPECIFICATIONS

Pin 1-6 Material: Copper alloy
 Plating: Min Au 0.1 µm over 1-3 µm Ni.

Recommended pad dimensions are only for reference. It is the end users decision based on different situations like production processes, substrate thickness etc.

Weight: Typical 13.5 g
 All dimensions in mm [inch]
 Tolerances unless specified:
 x.x ±0.50 [0.02],
 x.xx±0.25 [0.01]
 (not applied on footprint or typical values)



PKU 4800C Series DC-DC Converters
 Input 36-75 V, Output up to 7 A / 86 W

28701-BMR67103 Rev.E

Feb 2020

© Flex

Mechanical Information – Thru Hole Version

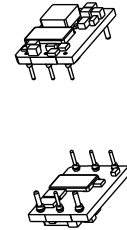
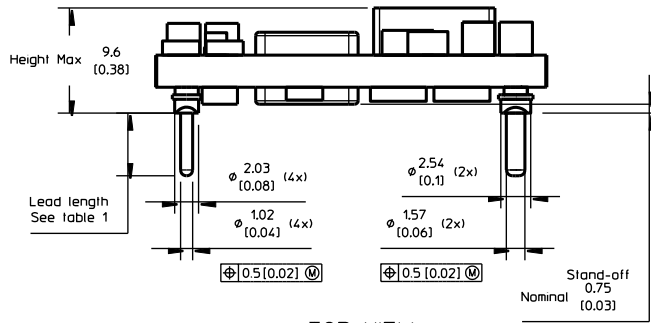

TOP VIEW

Pin positions according to recommended footprint

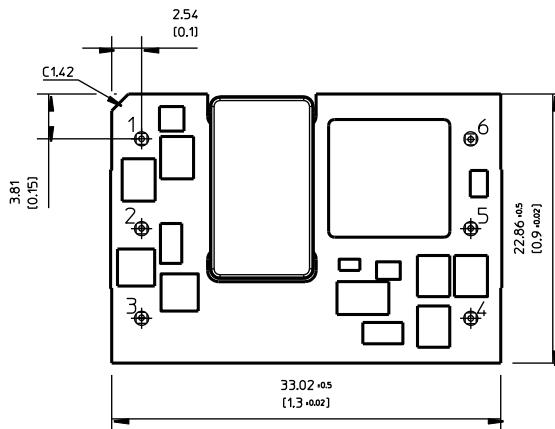

RECOMMENDED FOOTPRINT - TOP VIEW

Table 1

Pin option	Lead length
Standard	5.33 [0.210]
LA	3.69 [0.145]
LB	4.57 [0.180]
LC	2.79 [0.110]

PIN SPECIFICATIONS

Pin 1-6 Material: Copper alloy
 Plating: Min Au 0.1 μ m over 1-3 μ m Ni.

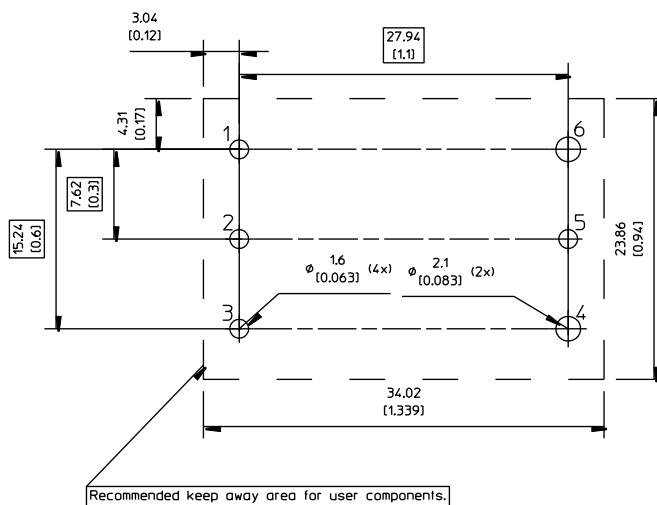

Recommended hole dimensions are only for reference. It is the end users decision based on different situations like production processes, substrate thickness etc.

Weight: Typical 13.9 g
 All dimensions in mm [inch]
 Tolerances unless specified:
 x.x ±0.50 [0.02]
 x.xx±0.25 [0.01]
 (not applied on footprint or typical values)



PKU 4800C Series DC-DC Converters
 Input 36-75 V, Output up to 7 A / 86 W

28701-BMR67103 Rev.E

Feb 2020

© Flex

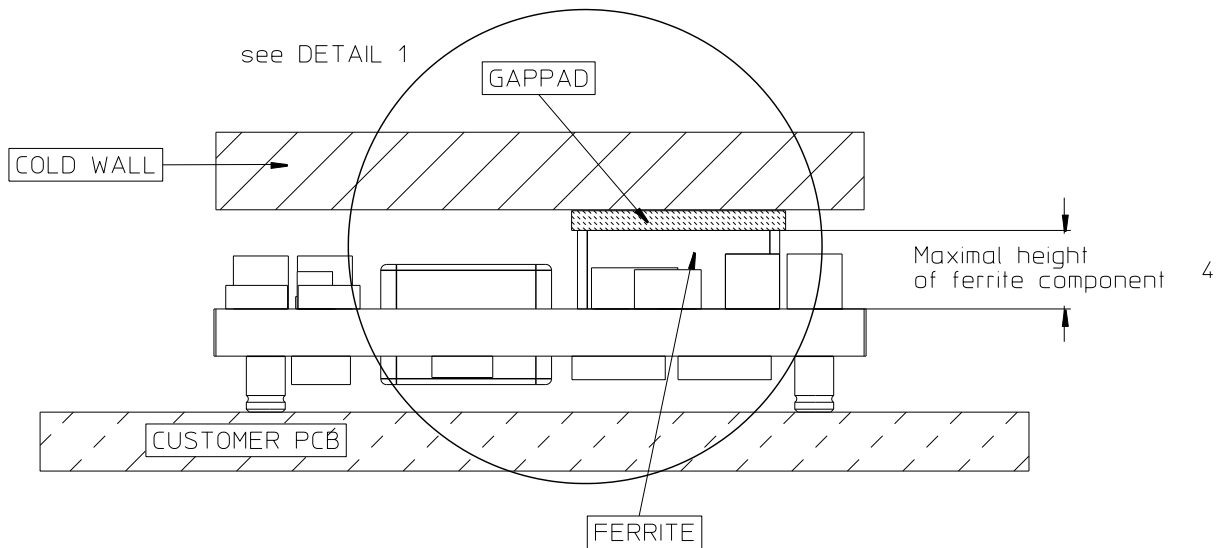

Thermal pad:

The thermal gap pad is intended to withdraw heat from the ferrite and transport the heat through the thermal material to the cold wall.

The gap pad must be carefully chosen in accordance with thermal conductivity and mounting pressure.

To choose the correct gap filler material height difference between the two ferrites must taken into consideration.

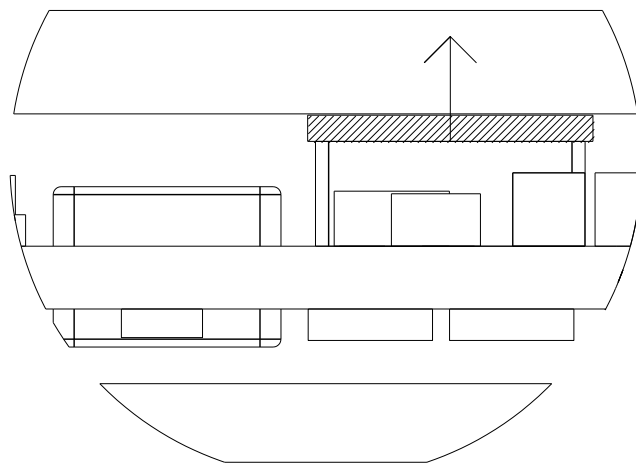

Heat transportation from ferrite to cold wall (see arrows)

DETAIL 1
 Scale 4:1

PKU 4800C Series DC-DC Converters
Input 36-75 V, Output up to 7 A / 86 W

28701-BMR67103 Rev.E

Feb 2020

© Flex

Soldering Information - Surface Mounting

The surface mount product is intended for forced convection or vapor phase reflow soldering in SnPb and Pb-free processes.

The reflow profile should be optimised to avoid excessive heating of the product. It is recommended to have a sufficiently extended preheat time to ensure an even temperature across the host PWB and it is also recommended to minimize the time in reflow.

A no-clean flux is recommended to avoid entrapment of cleaning fluids in cavities inside the product or between the product and the host board, since cleaning residues may affect long time reliability and isolation voltage.

General reflow process specifications		SnPb eutectic	Pb-free
Average ramp-up ($T_{PRODUCT}$)		3°C/s max	3°C/s max
Typical solder melting (liquidus) temperature	T_L	183°C	221°C
Minimum reflow time above T_L		60 s	60 s
Minimum pin temperature	T_{PIN}	210°C	235°C
Peak product temperature	$T_{PRODUCT}$	225°C	260°C
Average ramp-down ($T_{PRODUCT}$)		6°C/s max	6°C/s max
Maximum time 25°C to peak		6 minutes	8 minutes

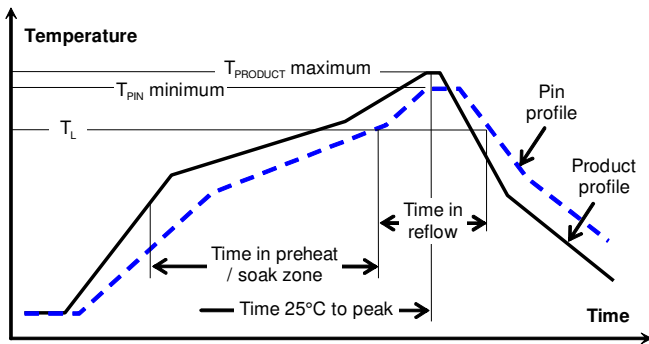

Minimum Pin Temperature Recommendations

Pin number 3 chosen as reference location for the minimum pin temperature recommendation since this will likely be the coolest solder joint during the reflow process.

SnPb solder processes

For SnPb solder processes, a pin temperature (T_{PIN}) in excess of the solder melting temperature, (T_L , 183°C for Sn63Pb37) for more than 60 seconds and a peak temperature of 220°C is recommended to ensure a reliable solder joint.

For dry packed products only: depending on the type of solder paste and flux system used on the host board, up to a recommended maximum temperature of 245°C could be used, if the products are kept in a controlled environment (dry pack handling and storage) prior to assembly.

Lead-free (Pb-free) solder processes

For Pb-free solder processes, a pin temperature (T_{PIN}) in excess of the solder melting temperature (T_L , 217 to 221°C for SnAgCu solder alloys) for more than 60 seconds and a peak temperature of 245°C on all solder joints is recommended to ensure a reliable solder joint.

Maximum Product Temperature Requirements

Top of the product PWB near pin 6 is chosen as reference location for the maximum (peak) allowed product temperature ($T_{PRODUCT}$) since this will likely be the warmest part of the product during the reflow process.

SnPb solder processes

For SnPb solder processes, the product is qualified for MSL 1 according to IPC/JEDEC standard J-STD-020C.

During reflow $T_{PRODUCT}$ must not exceed 225 °C at any time.

Pb-free solder processes

For Pb-free solder processes, the product is qualified for MSL 3 according to IPC/JEDEC standard J-STD-020C.

During reflow $T_{PRODUCT}$ must not exceed 260 °C at any time.

Dry Pack Information

Products intended for Pb-free reflow soldering processes are delivered in standard moisture barrier bags according to IPC/JEDEC standard J-STD-033 (Handling, packing, shipping and use of moisture/reflow sensitivity surface mount devices).

Using products in high temperature Pb-free soldering processes requires dry pack storage and handling. In case the products have been stored in an uncontrolled environment and no longer can be considered dry, the modules must be baked according to J-STD-033.

Thermocoupler Attachment

Top of PWB near pin 6 for measurement of maximum product temperature, $T_{PRODUCT}$

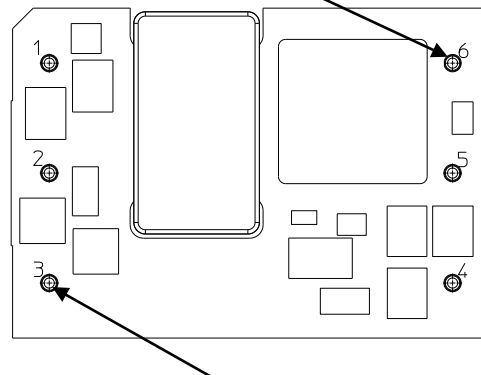

Pin 3 for measurement of minimum pin (solder joint) temperature, T_{PIN}

PKU 4800C Series DC-DC Converters
 Input 36-75 V, Output up to 7 A / 86 W

28701-BMR67103 Rev.E

Feb 2020

© Flex

Soldering Information - Hole Mounting

The hole mounted product is intended for plated through hole mounting by wave or manual soldering. The pin temperature is specified to maximum to 270°C for maximum 10 seconds.

A maximum preheat rate of 4°C/s and maximum preheat temperature of 150°C is suggested. When soldering by hand, care should be taken to avoid direct contact between the hot soldering iron tip and the pins for more than a few seconds in order to prevent overheating.

A no-clean flux is recommended to avoid entrapment of cleaning fluids in cavities inside the product or between the product and the host board. The cleaning residues may affect long time reliability and isolation voltage.

Delivery Package Information

The products are delivered in antistatic injection molded trays (Jedec design guide 4.10D standard) and in antistatic trays.

Tray Specifications – SMD /Pin in paste	
Material	Antistatic PPE
Surface resistance	$10^5 < \text{Ohm/square} < 10^{11}$
Bakability	The trays can be baked at maximum 125°C for 48 hours
Tray thickness	18.50 mm 0.728 [inch]
Box capacity	150 products (5 full trays/box)
Tray weight	125 g empty, 500 g full tray

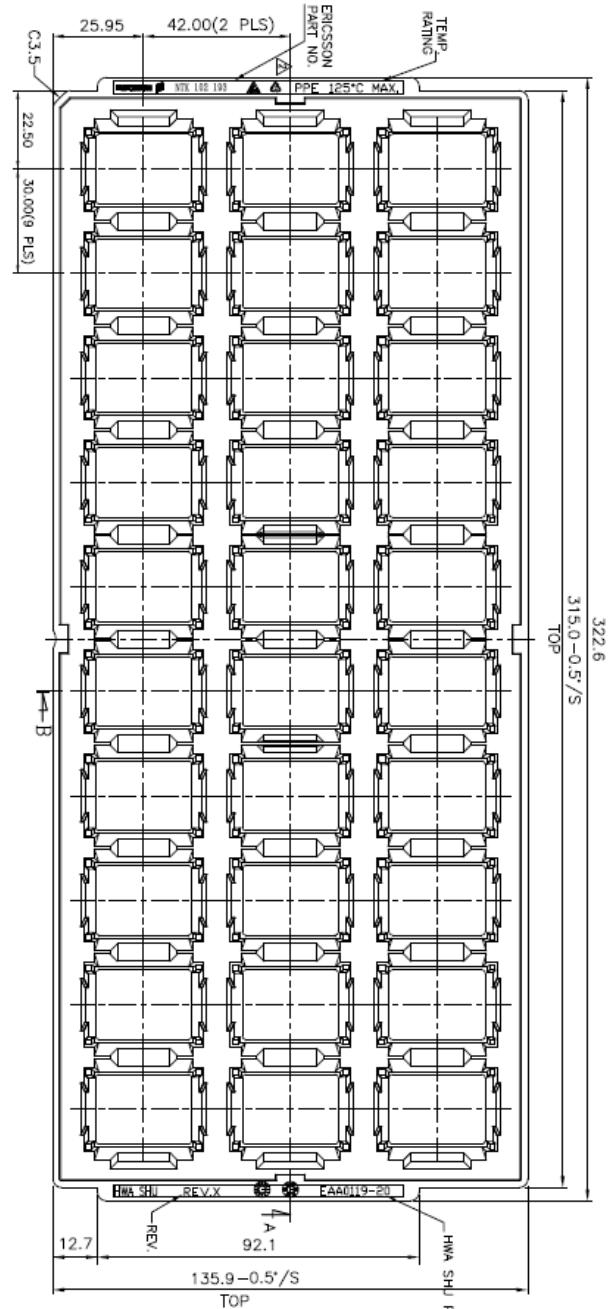

JEDEC standard tray for 3x10 = 30 products.
 All dimensions in mm [inch]
 Tolerances: X.x ±0.26 [0.01], X.xx ±0.13 [0.005]
 Note: pick up positions refer to center of pocket.
 See mechanical drawing for exact location on product.

PKU 4800C Series DC-DC Converters
Input 36-75 V, Output up to 7 A / 86 W

28701-BMR67103 Rev.E

Feb 2020

© Flex

Product Qualification Specification

Characteristics			
External visual inspection	IPC-A-610		
Change of temperature (Temperature cycling)	IEC 60068-2-14 Na	Temperature range Number of cycles Dwell/transfer time	-40 to 100°C 1000 15 min/0-1 min
Cold (in operation)	IEC 60068-2-1 Ad	Temperature T _A Duration	-45°C 72 h
Damp heat	IEC 60068-2-67 Cy	Temperature Humidity Duration	85°C 85 % RH 1000 hours
Dry heat	IEC 60068-2-2 Bd	Temperature Duration	125°C 1000 h
Electrostatic discharge susceptibility	IEC 61340-3-1, JESD 22-A114 IEC 61340-3-2, JESD 22-A115	Human body model (HBM) Machine Model (MM)	Class 1B, 500 V Class 3, 200 V
Immersion in cleaning solvents	IEC 60068-2-45 XA, method 2	Water Glycol ether Isopropyl alcohol	55°C 35°C 35°C
Mechanical shock	IEC 60068-2-27 Ea	Peak acceleration Duration	100 g 6 ms
Moisture reflow sensitivity ¹	J-STD-020C	Level 1 (SnPb-eutectic) Level 3 (Pb Free)	225°C 260°C
Operational life test	MIL-STD-202G, method 108A	Duration	1000 h
Resistance to soldering heat ²	IEC 60068-2-20 Tb, method 1A	Solder temperature Duration	270°C 10-13 s
Robustness of terminations	IEC 60068-2-21 Test Ua1 IEC 60068-2-21 Test Ue1	Through hole mount products Surface mount products	All leads All leads
Solderability	IEC 60068-2-58 test Td ¹	Preconditioning Temperature, SnPb Eutectic Temperature, Pb-free	150°C dry bake 16 h 215°C 235°C
	IEC 60068-2-20 test Ta ²	Preconditioning Temperature, SnPb Eutectic Temperature, Pb-free	Steam ageing 235°C 245°C
Vibration, broad band random	IEC 60068-2-64 Fh, method 1	Frequency Spectral density Duration	10 to 500 Hz 0.07 g ² /Hz 10 min in each direction

Notes

¹ Only for products intended for reflow soldering (surface mount products)

² Only for products intended for wave soldering (plated through hole products)