

LDO Regulator

BD3650FP-M

General Description

The BD3650FP-M is a low-saturation regulator. This IC has a built-in over-current protection circuit that prevents the destruction of the IC due to output short circuits. It also has a built-in thermal shutdown circuit that protects the IC from thermal damage due to overloading.

Features

- High Output Voltage Precision: $\pm 2\%$
- Low Saturation with PDMOS Output
- Built-in Over-Current Protection Circuit that Prevents Destruction of the IC Due to Output Short Circuits
- Built-in Thermal Shutdown Circuit that Protects the IC From Thermal Damage Due to Overloading
- Low ESR Capacitor

Applications

Onboard devices (vehicle equipment, car stereos, satellite navigation systems, etc.)

Key Specifications

- Input Supply Voltage Range: 5.6V to 30V
- Output Voltage: 5.0V (Typ)
- Output Current: 0.3A (Max)
- Operating Temperature Range: -40°C to $+125^{\circ}\text{C}$

Package

W(Typ) x D(Typ) x H(Max)



TO252-3

6.50mm x 9.50mm x 2.50mm

Block Diagram

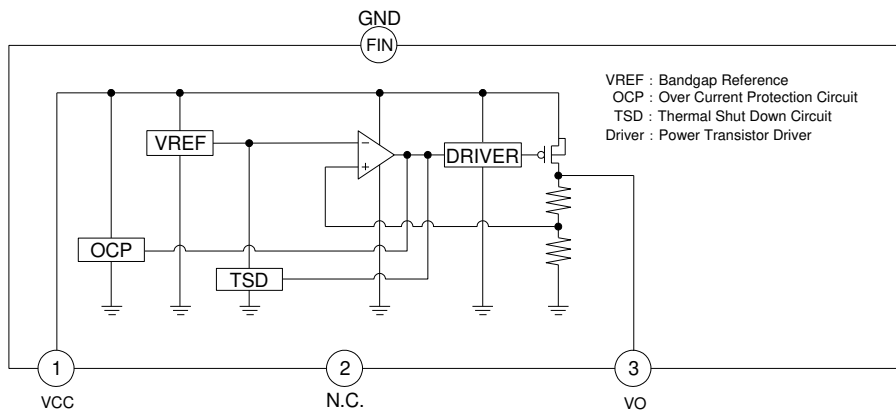

Pin Configuration

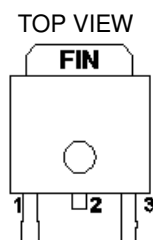

Pin Descriptions

Pin No.	Pin Name	Function
1	VCC	Power supply pin
2	N.C.	No connection pin
3	VO	Output pin
FIN	GND	GND

Absolute Maximum Ratings (Ta=25°C)

Parameter	Symbol	Rating	Unit
Supply Voltage (Note 1)	V _{CC}	-0.3 to +36.0	V
Power Dissipation (Note 2)	P _d	1.2	W
Operating Temperature Range	T _{opr}	-40 to +125	°C
Storage Temperature Range	T _{stg}	-55 to +150	°C
Maximum Junction Temperature	T _{jmax}	150	°C

(Note 1) Not to exceed P_d.

(Note 2) TO252-3: Derate by 9.6mW /°C when operating above Ta = 25°C and when mounted on glass epoxy board with dimensions =70mm x 70mm x 1.6mm.

Caution: Operating the IC over the absolute maximum ratings may damage the IC. The damage can either be a short circuit between pins or an open circuit between pins and the internal circuitry. Therefore, it is important to consider circuit protection measures, such as adding a fuse, in case the IC is operated over the absolute maximum ratings.

Recommended Operating Conditions (Ta=-40°C to +125°C)

Parameter	Symbol	Min	Max	Unit
Supply Voltage (Note 3)	V _{CC}	5.6	30.0	V
Output Current	I _o	0	0.3	A

(Note 3) The voltage drop (dropout voltage) due to the output current should be considered.

Electrical Characteristics (Unless otherwise specified, Ta=-40°C to +125°C, V_{CC}=10V, I_o=0mA)

Parameter	Symbol	Min	Typ	Max	Unit	Conditions
Circuit Current	I _{CC}	-	0.5	1.0	mA	
Output voltage	V _O	4.90	5.00	5.10	V	I _o =200mA
Dropout Voltage	ΔV _D	-	0.2	0.4	V	V _{CC} =V _O × 0.95, I _o =200mA
Ripple Rejection	R.R.	45	60	-	dB	f=120Hz, e _{in} =1V _{RMS} , I _o =100mA
Line Regulation	REG _I	-	5	35	mV	V _{CC} =5.6V to 30V
Load Regulation	REG _L	-	10	50	mV	I _o =10mA to 300mA

Typical Performance Curves

Unless otherwise specified, $T_a = -40^{\circ}\text{C}$ to $+125^{\circ}\text{C}$, $V_{CC} = 10\text{V}$, $I_o = 0\text{mA}$

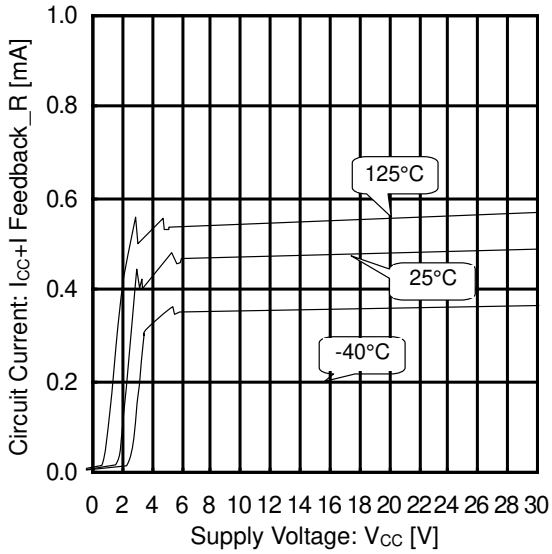

Figure 1. Circuit Current vs Supply Voltage

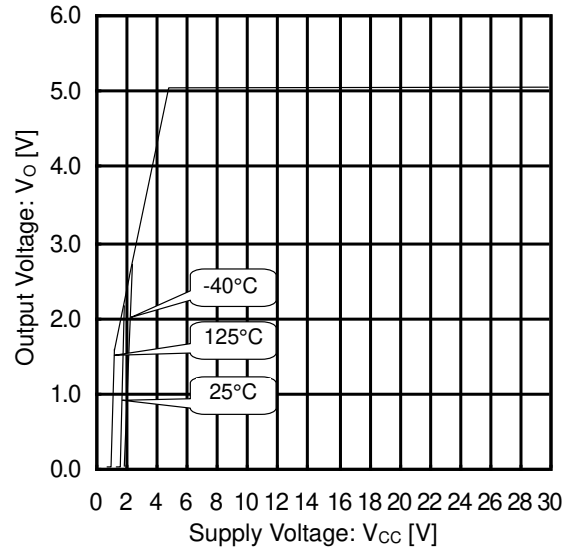

Figure 2. Output Voltage vs Supply Voltage (Line Regulation, $I_o = 0\text{mA}$)

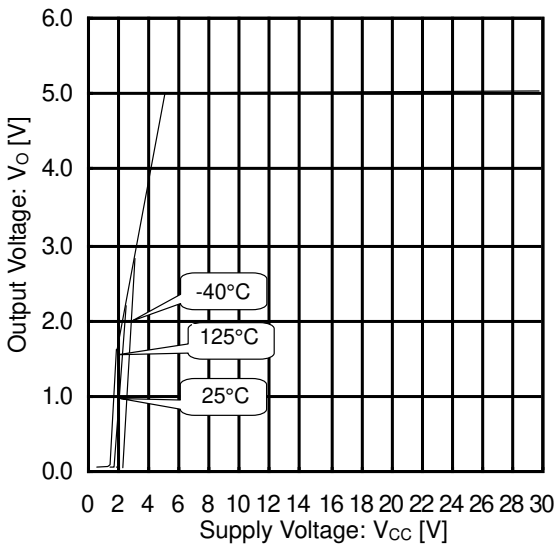

Figure 3. Output Voltage vs Supply Voltage (Line Regulation, $I_o = 200\text{mA}$)

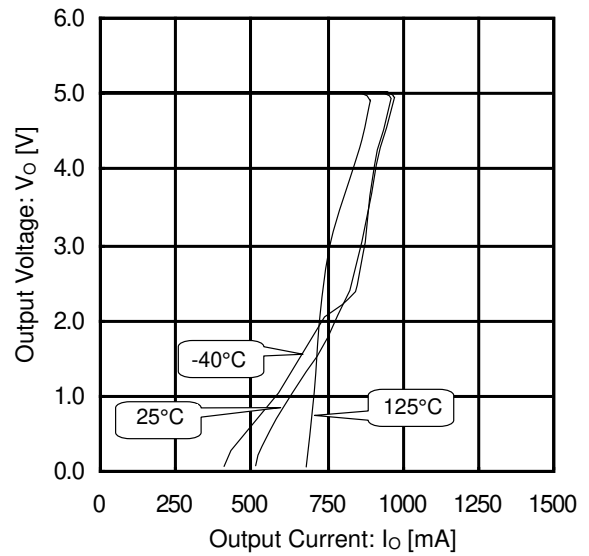

Figure 4. Output Voltage vs Output Current (Load Stability)

Typical Performance Curves – continued

Unless otherwise specified, $T_a = -40^\circ\text{C}$ to $+125^\circ\text{C}$, $V_{CC} = 10\text{V}$, $I_o = 0\text{mA}$

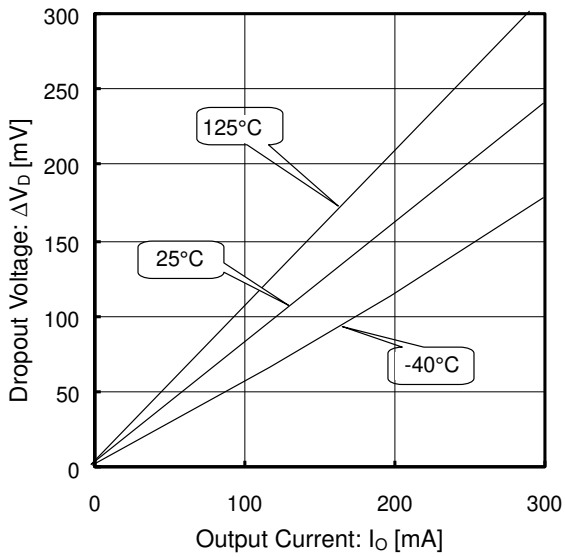

Figure 5. Dropout Voltage vs Output Current ($V_{CC} = 4.75\text{V}$, $I_o = 0\text{mA}$ to 300mA)

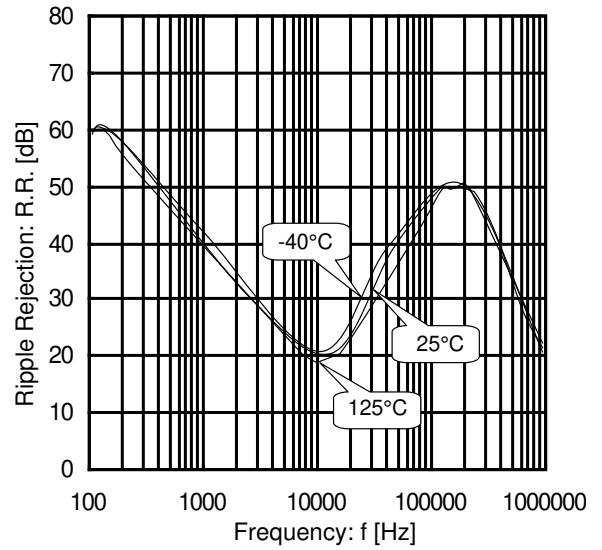

Figure 6. Ripple Rejection vs Frequency ($I_o = 100\text{mA}$)

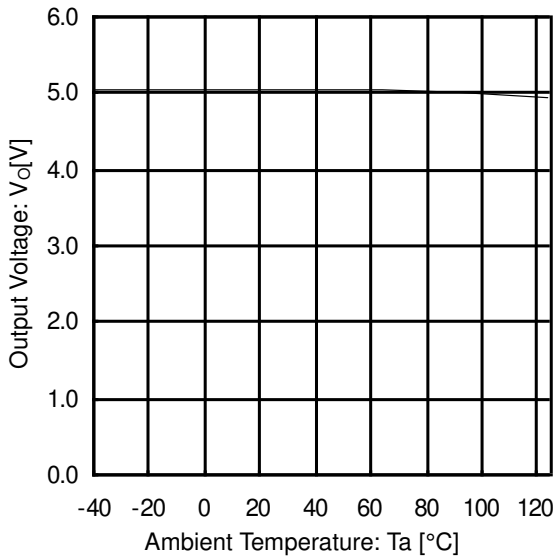

Figure 7. Output Voltage vs Ambient Temperature

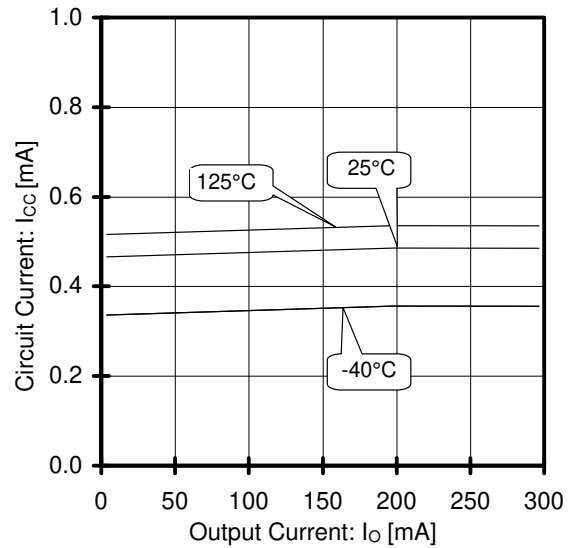

Figure 8. Circuit Current vs Output Current ($I_o = 0\text{mA}$ to 300mA)

Typical Performance Curves – continued

Unless otherwise specified, $T_a = -40^{\circ}\text{C}$ to $+125^{\circ}\text{C}$, $V_{CC} = 10\text{V}$, $I_O = 0\text{mA}$

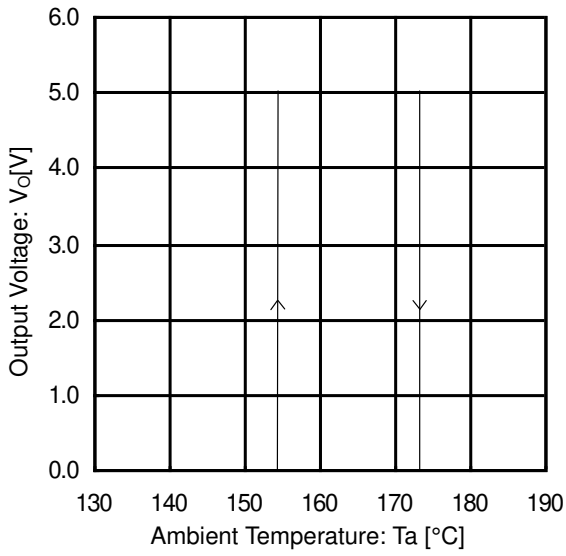
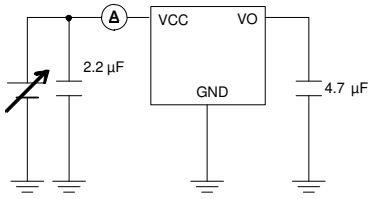
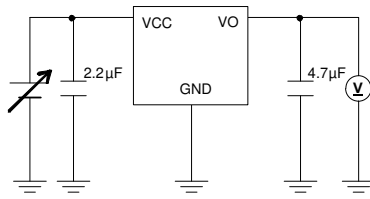

Figure 9. Output Voltage vs Ambient Temperature
(Thermal Shutdown Circuit Characteristics)

Measurement Circuit for Typical Performance Curves



Measurement Circuit of Figure 1.



Measurement Circuit of Figure 2.

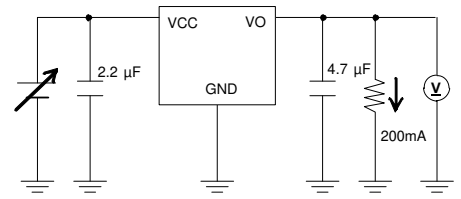

Measurement Circuit of Figure 3.

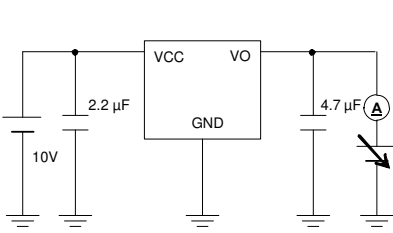

Measurement Circuit of Figure 4.

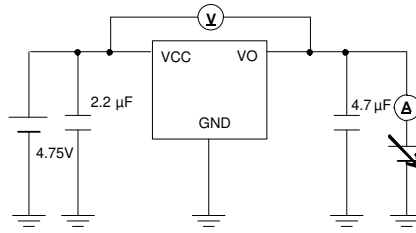

Measurement Circuit of Figure 5.

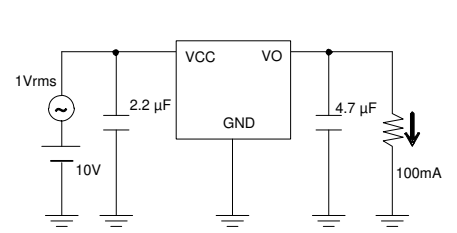

Measurement Circuit of Figure 6.

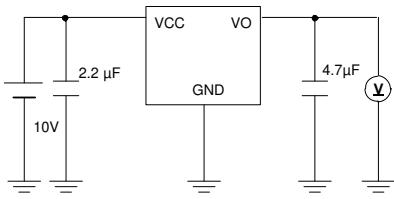

Measurement Circuit of Figure 7.

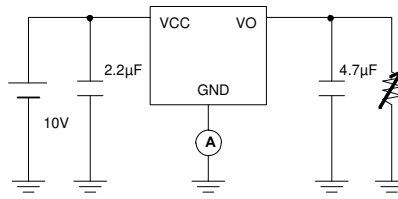

Measurement Circuit of Figure 8.

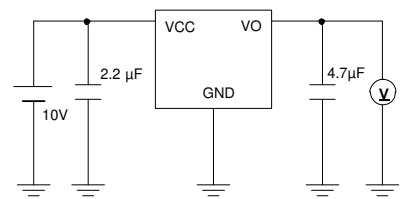

Measurement Circuit of Figure 9.

Power Dissipation

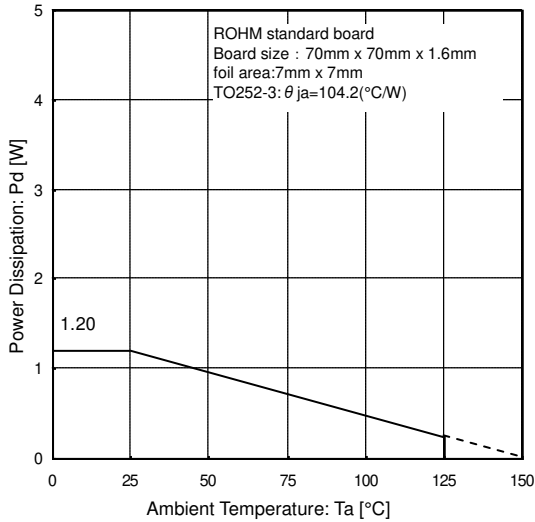

Figure 10

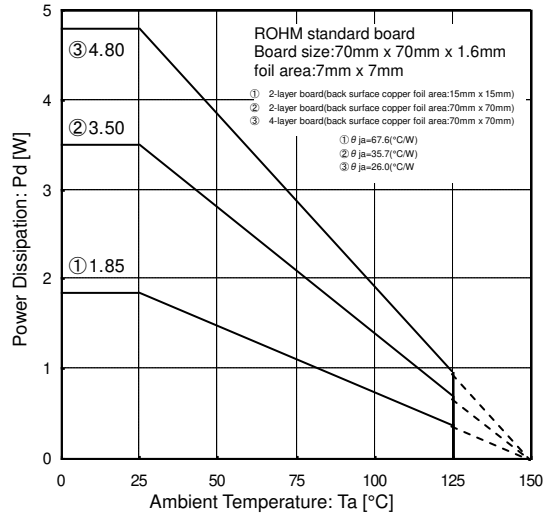

Figure 11
(Reference Data)

When operating at temperatures above $T_a=25^\circ\text{C}$, please refer to the derating factor shown in Figure 10 and Figure 11. The IC characteristics are closely related to the temperature at which the IC is used. It is necessary to operate the IC at temperatures below the maximum junction temperature (T_{jmax}).

Figure 10 and Figure 11 show the acceptable loss and derating factor of the TO252-3 package. The chip junction temperature (T_j) may be quite high even if the ambient temperature (T_a) is at room temperature (25°C). It is recommended to operate the IC at temperatures where Power Consumption (P_c) is less than the Power Dissipation (P_d).

The calculation method for Power Consumption P_c (W) is as follows : (Figure 11③)

$$P_c = (V_{CC} - V_O) \times I_O + V_{CC} \times I_{CC}$$

Acceptable loss $P_d \geq P_c$

Solving for load current I_o in order to operate within the acceptable dissipation,

$$I_O \leq \frac{P_d - V_{CC} \times I_{CC}}{V_{CC} - V_O} \quad (\text{Please refer to Figure 8 for } I_{CC}.)$$

where:

- V_{CC} is the Input voltage
- V_O is the Output voltage
- I_O is the Load current
- I_{CC} is the Circuit current
- I_{short} is the Short current

It is then possible to find the maximum load current (I_{OMAX}) with respect to the applied voltage (V_{cc}) at the time of thermal design.

Calculation Example:

When $T_a=85^\circ\text{C}$, $V_{CC}=10\text{V}$, $V_O=5\text{V}$:

$$I_O \leq \frac{2.469 - 10 \times I_{CC}}{5} \quad \left(\begin{array}{l} \text{Figure 11③: } \theta_{ja}=26.0^\circ\text{C/W to } -38.4\text{mW}/^\circ\text{C} \\ 25^\circ\text{C}=4.80\text{W to } 85^\circ\text{C}=2.496\text{W} \end{array} \right)$$

$I_o \leq 300\text{mA}$ ($I_{CC}=0.5\text{mA}$)

Please refer to the information above to keep thermal designs within the scope of acceptable loss for all operating temperature ranges. The power consumption (P_c) of the IC when there is a short circuit (short between V_O and GND) is:

$$P_c = V_{CC}(I_{CC} + I_{short}) \quad (\text{Please refer to Figure 4 for } I_{short}.)$$

I/O Equivalent Circuit

(Resistances are Typical Values.)

VCC Pin

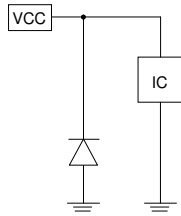

VO Pin

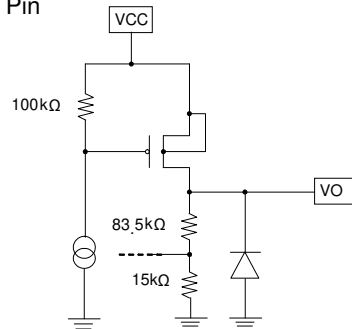

Operational Notes

1. **Reverse Connection of Power Supply**

Connecting the power supply in reverse polarity can damage the IC. Take precautions against reverse polarity when connecting the power supply, such as mounting an external diode between the power supply and the IC's power supply pins.

2. **Power Supply Lines**

Design the PCB layout pattern to provide low impedance supply lines. Separate the ground and supply lines of the digital and analog blocks to prevent noise in the ground and supply lines of the digital block from affecting the analog block. Furthermore, connect a capacitor to ground at all power supply pins. Consider the effect of temperature and aging on the capacitance value when using electrolytic capacitors.

3. **Ground Voltage**

Ensure that no pins are at a voltage below that of the ground pin at any time, even during transient condition.

4. **Ground Wiring Pattern**

When using both small-signal and large-current ground traces, the two ground traces should be routed separately but connected to a single ground at the reference point of the application board to avoid fluctuations in the small-signal ground caused by large currents. Also ensure that the ground traces of external components do not cause variations on the ground voltage. The ground lines must be as short and thick as possible to reduce line impedance.

5. **Thermal Consideration**

Should by any chance the power dissipation rating be exceeded the rise in temperature of the chip may result in deterioration of the properties of the chip. The absolute maximum rating of the Pd stated in this specification is when the IC is mounted on a 70mm x 70mm x 1.6mm glass epoxy board. In case of exceeding this absolute maximum rating, increase the board size and copper area to prevent exceeding the Pd rating.

$$\left(\begin{array}{l} T_{j\max} : \text{Maximum junction temperature}=150[^\circ\text{C}] , T_a : \text{Peripheral temperature}[^\circ\text{C}] , \\ \theta_{ja} : \text{Thermal resistance of package-ambience}[^\circ\text{C}/\text{W}] , P_d : \text{Package Power dissipation [W]} , \\ P_c : \text{Power dissipation [W]} , V_{CC} : \text{Input Voltage} , V_O : \text{Output Voltage} , I_O : \text{Load} , I_{CC} : \text{Circuit Current} \end{array} \right)$$

$$\text{Package Power dissipation} \quad : \quad P_d(W) = (T_{j\max} - T_a) / \theta_{ja}$$

$$\text{Power dissipation} \quad : \quad P_c(W) = (V_{CC} - V_O) \times I_O + V_{CC} \times I_{CC}$$

6. **Recommended Operating Conditions**

These conditions represent a range within which the expected characteristics of the IC can be approximately obtained. The electrical characteristics are guaranteed under the conditions of each parameter.

7. **Inrush Current**

When power is first supplied to the IC, it is possible that the internal logic may be unstable and inrush current may flow instantaneously due to the internal powering sequence and delays, especially if the IC has more than one power supply. Therefore, give special consideration to power coupling capacitance, power wiring, width of ground wiring, and routing of connections.

8. **Testing on Application Boards**

When testing the IC on an application board, connecting a capacitor directly to a low-impedance output pin may subject the IC to stress. Always discharge capacitors completely after each process or step. The IC's power supply should always be turned off completely before connecting or removing it from the test setup during the inspection process. To prevent damage from static discharge, ground the IC during assembly and use similar precautions during transport and storage.

9. **Inter-pin Short and Mounting Errors**

Ensure that the direction and position are correct when mounting the IC on the PCB. Incorrect mounting may result in damaging the IC. Avoid nearby pins being shorted to each other especially to ground, power supply and output pin. Inter-pin shorts could be due to many reasons such as metal particles, water droplets (in very humid environment) and unintentional solder bridge deposited in between pins during assembly to name a few.

Operational Notes – continued

10. Unused Input Pins

Input pins of an IC are often connected to the gate of a MOS transistor. The gate has extremely high impedance and extremely low capacitance. If left unconnected, the electric field from the outside can easily charge it. The small charge acquired in this way is enough to produce a significant effect on the conduction through the transistor and cause unexpected operation of the IC. So unless otherwise specified, unused input pins should be connected to the power supply or ground line.

11. Regarding the Input Pin of the IC

This monolithic IC contains P+ isolation and P substrate layers between adjacent elements in order to keep them isolated. P-N junctions are formed at the intersection of the P layers with the N layers of other elements, creating a parasitic diode or transistor. For example (refer to figure below):

When $GND > Pin A$ and $GND > Pin B$, the P-N junction operates as a parasitic diode.
When $GND > Pin B$, the P-N junction operates as a parasitic transistor.

Parasitic diodes inevitably occur in the structure of the IC. The operation of parasitic diodes can result in mutual interference among circuits, operational faults, or physical damage. Therefore, conditions that cause these diodes to operate, such as applying a voltage lower than the GND voltage to an input pin (and thus to the P substrate) should be avoided.

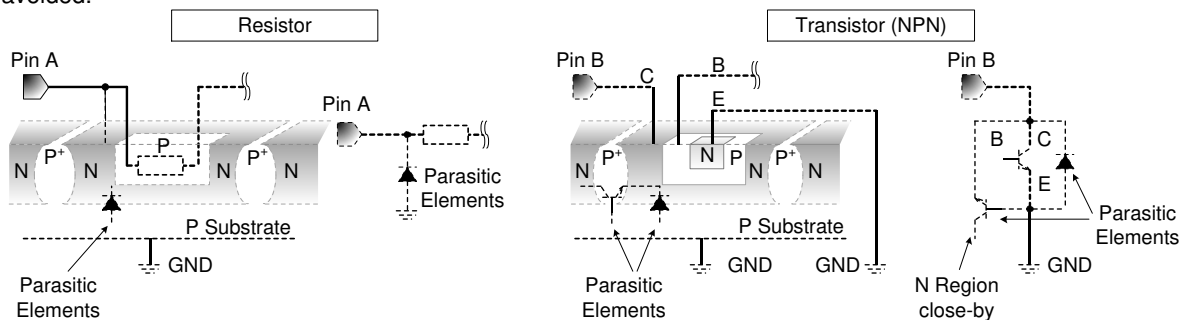

Figure 12. Example of monolithic IC structure

12. Thermal Shutdown Circuit(TSD)

This IC has a built-in thermal shutdown circuit that prevents heat damage to the IC. Normal operation should always be within the IC's power dissipation rating. If however the rating is exceeded for a continued period, the junction temperature (T_j) will rise which will activate the TSD circuit that will turn OFF all output pins. When the T_j falls below the TSD threshold, the circuits are automatically restored to normal operation.

Note that the TSD circuit operates in a situation that exceeds the absolute maximum ratings and therefore, under no circumstances, should the TSD circuit be used in a set design or for any purpose other than protecting the IC from heat damage.

13. Over Current Protection Circuit (OCP)

This IC incorporates an integrated overcurrent protection circuit that is activated when the load is shorted. This protection circuit is effective in preventing damage due to sudden and unexpected incidents. However, the IC should not be used in applications characterized by continuous operation or transitioning of the protection circuit.

14. VCC Pin

Insert a capacitor (capacitor $\geq 2.2\mu F$) between the VCC and GND pins. The appropriate capacitance value varies by application. Be sure to allow a sufficient margin for input voltage levels.

Operational Notes – continued

15. Output Pins

It is necessary to place capacitors between each output pin and GND to prevent oscillation on the output. Usable capacitance values range from 4.7µF to 1000µF. Ceramic capacitors can be used as long as their ESR value is low enough to prevent oscillation (0.001Ω to 2Ω). Abrupt fluctuations in input voltage and load conditions may affect the output voltage.

Output capacitance values should be determined only through sufficient testing of the actual application.

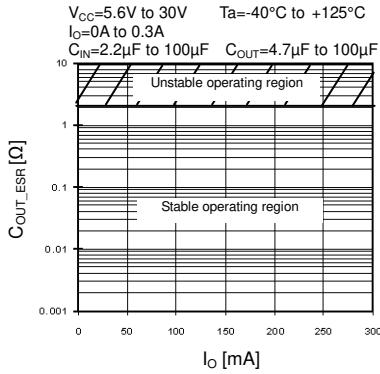

C_{OUT_ESR} vs I_O (Reference Data)

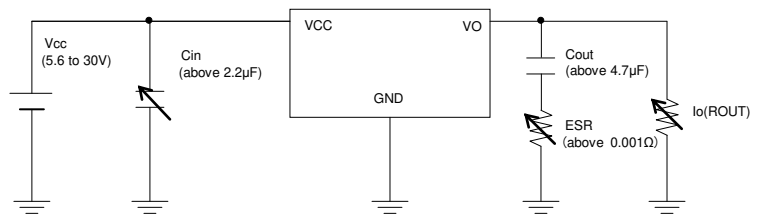

(Note) Measurement Circuit

16. In some application or process testing, the voltage on the VCC or other pins may be reversed. If a large capacitor is connected between the output and ground, the current from the charged capacitor can flow to the output and possibly damage the IC. In order to avoid these problems, limiting output pin capacitance to 1000µF or less and inserting a VCC series countercurrent prevention diode or bypass diode between the various pins and the VCC is recommended.

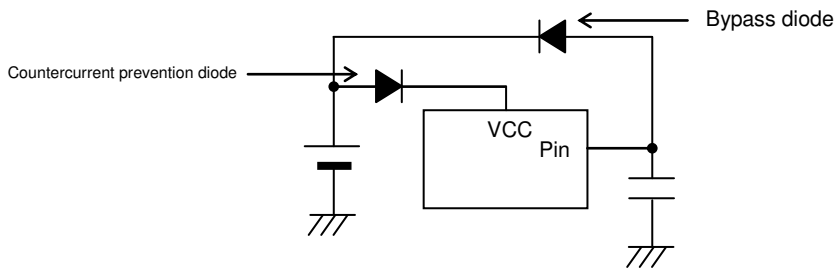

17. Positive voltage surges on VCC pin

A power Zener diode should be inserted between VCC and GND for protection against voltage surges of more than 36V on the VCC pin.

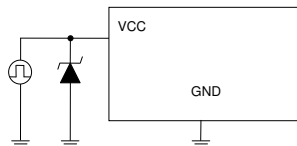

18. Negative voltage surges on VCC pin

A Schottky barrier diode should be inserted between VCC and GND for protection against voltages lower than GND on the VCC pin.

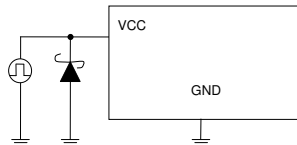

19. Output Protection Diode

Output loads with large inductive component may cause reverse current flow to the output pin during startup or shutdown. In such cases, a protection diode should be inserted at the output to protect the IC.

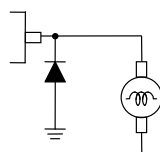

Ordering Information

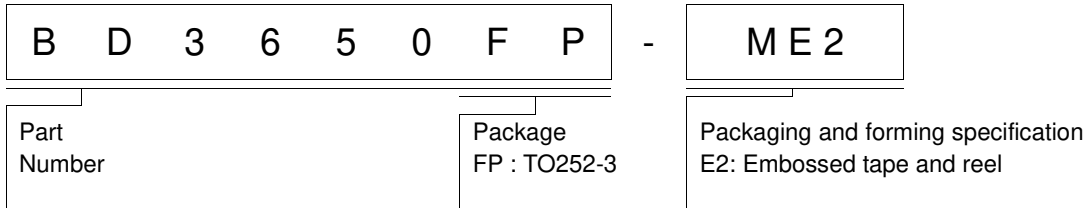

Marking Diagram

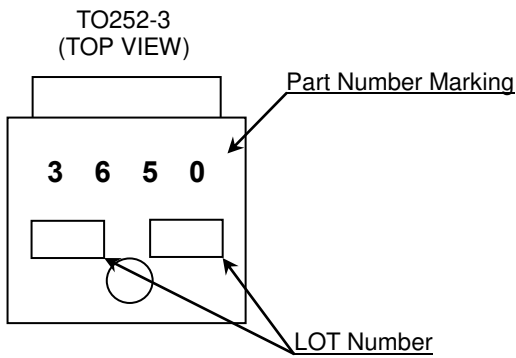

Part Number Marking	Package		Part Number
3650	TO252-3	Reel of 2000	BD3650FP – ME2

Physical Dimension, Tape and Reel Information

Package Name	TO252-3
--------------	---------

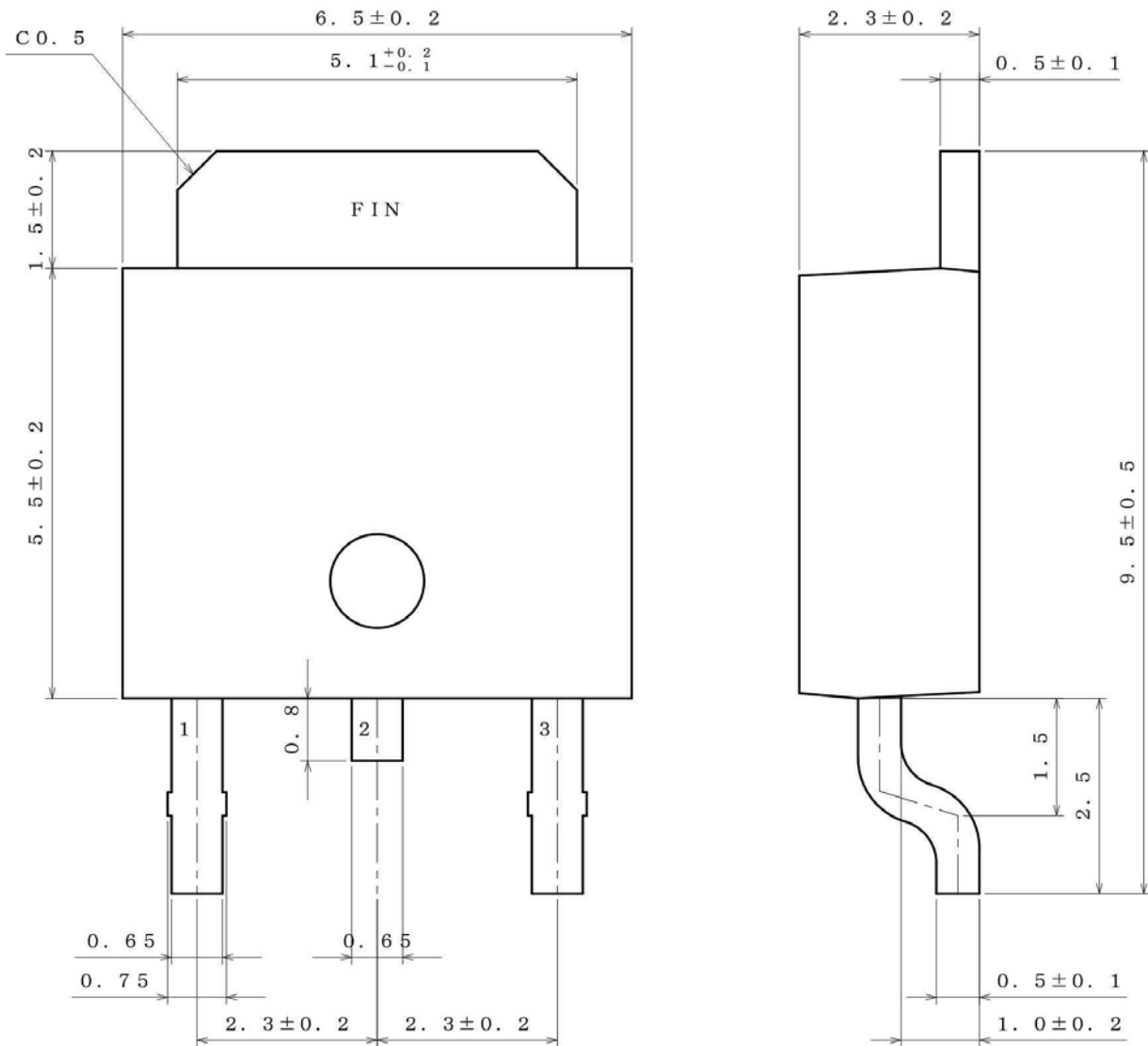

(UNITS ; mm)

PKG : TO252-3

Drawing No. EX535-5001-1

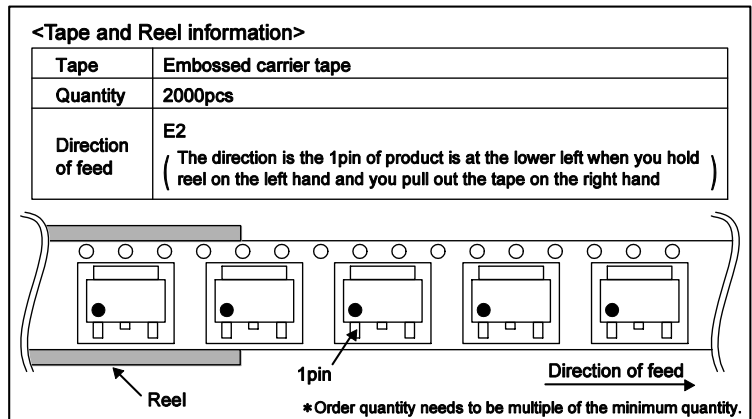

Revision History

Date	Revision	Changes
20.Oct.2014	001	New Release

Notice

Precaution on using ROHM Products

1. If you intend to use our Products in devices requiring extremely high reliability (such as medical equipment ^(Note 1), aircraft/spacecraft, nuclear power controllers, etc.) and whose malfunction or failure may cause loss of human life, bodily injury or serious damage to property ("Specific Applications"), please consult with the ROHM sales representative in advance. Unless otherwise agreed in writing by ROHM in advance, ROHM shall not be in any way responsible or liable for any damages, expenses or losses incurred by you or third parties arising from the use of any ROHM's Products for Specific Applications.

(Note1) Medical Equipment Classification of the Specific Applications

JAPAN	USA	EU	CHINA
CLASS III	CLASS III	CLASS II b	CLASS III
CLASS IV		CLASS III	

2. ROHM designs and manufactures its Products subject to strict quality control system. However, semiconductor products can fail or malfunction at a certain rate. Please be sure to implement, at your own responsibilities, adequate safety measures including but not limited to fail-safe design against the physical injury, damage to any property, which a failure or malfunction of our Products may cause. The following are examples of safety measures:
 - [a] Installation of protection circuits or other protective devices to improve system safety
 - [b] Installation of redundant circuits to reduce the impact of single or multiple circuit failure
3. Our Products are not designed under any special or extraordinary environments or conditions, as exemplified below. Accordingly, ROHM shall not be in any way responsible or liable for any damages, expenses or losses arising from the use of any ROHM's Products under any special or extraordinary environments or conditions. If you intend to use our Products under any special or extraordinary environments or conditions (as exemplified below), your independent verification and confirmation of product performance, reliability, etc. prior to use, must be necessary:
 - [a] Use of our Products in any types of liquid, including water, oils, chemicals, and organic solvents
 - [b] Use of our Products outdoors or in places where the Products are exposed to direct sunlight or dust
 - [c] Use of our Products in places where the Products are exposed to sea wind or corrosive gases, including Cl₂, H₂S, NH₃, SO₂, and NO₂
 - [d] Use of our Products in places where the Products are exposed to static electricity or electromagnetic waves
 - [e] Use of our Products in proximity to heat-producing components, plastic cords, or other flammable items
 - [f] Sealing or coating our Products with resin or other coating materials
 - [g] Use of our Products without cleaning residue of flux (even if you use no-clean type fluxes, cleaning residue of flux is recommended); or Washing our Products by using water or water-soluble cleaning agents for cleaning residue after soldering
 - [h] Use of the Products in places subject to dew condensation
4. The Products are not subject to radiation-proof design.
5. Please verify and confirm characteristics of the final or mounted products in using the Products.
6. In particular, if a transient load (a large amount of load applied in a short period of time, such as pulse. is applied, confirmation of performance characteristics after on-board mounting is strongly recommended. Avoid applying power exceeding normal rated power; exceeding the power rating under steady-state loading condition may negatively affect product performance and reliability.
7. De-rate Power Dissipation (Pd) depending on Ambient temperature (Ta). When used in sealed area, confirm the actual ambient temperature.
8. Confirm that operation temperature is within the specified range described in the product specification.
9. ROHM shall not be in any way responsible or liable for failure induced under deviant condition from what is defined in this document.

Precaution for Mounting / Circuit board design

1. When a highly active halogenous (chlorine, bromine, etc.) flux is used, the residue of flux may negatively affect product performance and reliability.
2. In principle, the reflow soldering method must be used on a surface-mount products, the flow soldering method must be used on a through hole mount products. If the flow soldering method is preferred on a surface-mount products, please consult with the ROHM representative in advance.

For details, please refer to ROHM Mounting specification

Precautions Regarding Application Examples and External Circuits

1. If change is made to the constant of an external circuit, please allow a sufficient margin considering variations of the characteristics of the Products and external components, including transient characteristics, as well as static characteristics.
2. You agree that application notes, reference designs, and associated data and information contained in this document are presented only as guidance for Products use. Therefore, in case you use such information, you are solely responsible for it and you must exercise your own independent verification and judgment in the use of such information contained in this document. ROHM shall not be in any way responsible or liable for any damages, expenses or losses incurred by you or third parties arising from the use of such information.

Precaution for Electrostatic

This Product is electrostatic sensitive product, which may be damaged due to electrostatic discharge. Please take proper caution in your manufacturing process and storage so that voltage exceeding the Products maximum rating will not be applied to Products. Please take special care under dry condition (e.g. Grounding of human body / equipment / solder iron, isolation from charged objects, setting of ionizer, friction prevention and temperature / humidity control).

Precaution for Storage / Transportation

1. Product performance and soldered connections may deteriorate if the Products are stored in the places where:
 - [a] the Products are exposed to sea winds or corrosive gases, including Cl₂, H₂S, NH₃, SO₂, and NO₂
 - [b] the temperature or humidity exceeds those recommended by ROHM
 - [c] the Products are exposed to direct sunshine or condensation
 - [d] the Products are exposed to high Electrostatic
2. Even under ROHM recommended storage condition, solderability of products out of recommended storage time period may be degraded. It is strongly recommended to confirm solderability before using Products of which storage time is exceeding the recommended storage time period.
3. Store / transport cartons in the correct direction, which is indicated on a carton with a symbol. Otherwise bent leads may occur due to excessive stress applied when dropping of a carton.
4. Use Products within the specified time after opening a humidity barrier bag. Baking is required before using Products of which storage time is exceeding the recommended storage time period.

Precaution for Product Label

QR code printed on ROHM Products label is for ROHM's internal use only.

Precaution for Disposition

When disposing Products please dispose them properly using an authorized industry waste company.

Precaution for Foreign Exchange and Foreign Trade act

Since our Products might fall under controlled goods prescribed by the applicable foreign exchange and foreign trade act, please consult with ROHM representative in case of export.

Precaution Regarding Intellectual Property Rights

1. All information and data including but not limited to application example contained in this document is for reference only. ROHM does not warrant that foregoing information or data will not infringe any intellectual property rights or any other rights of any third party regarding such information or data. ROHM shall not be in any way responsible or liable for infringement of any intellectual property rights or other damages arising from use of such information or data.:
2. No license, expressly or implied, is granted hereby under any intellectual property rights or other rights of ROHM or any third parties with respect to the information contained in this document.

Other Precaution

1. This document may not be reprinted or reproduced, in whole or in part, without prior written consent of ROHM.
2. The Products may not be disassembled, converted, modified, reproduced or otherwise changed without prior written consent of ROHM.
3. In no event shall you use in any way whatsoever the Products and the related technical information contained in the Products or this document for any military purposes, including but not limited to, the development of mass-destruction weapons.
4. The proper names of companies or products described in this document are trademarks or registered trademarks of ROHM, its affiliated companies or third parties.

General Precaution

1. Before you use our Products, you are requested to carefully read this document and fully understand its contents. ROHM shall not be in any way responsible or liable for failure, malfunction or accident arising from the use of any ROHM's Products against warning, caution or note contained in this document.
2. All information contained in this document is current as of the issuing date and subject to change without any prior notice. Before purchasing or using ROHM's Products, please confirm the latest information with a ROHM sales representative.
3. The information contained in this document is provided on an "as is" basis and ROHM does not warrant that all information contained in this document is accurate and/or error-free. ROHM shall not be in any way responsible or liable for any damages, expenses or losses incurred by you or third parties resulting from inaccuracy or errors of or concerning such information.