



2.5 x 2.0 mm Precision TCXO Model B31

CONNOR WINFIELD



2111 Comprehensive Drive

Aurora, Illinois 60505

Phone: 630-851-4722

Fax: 630-851-5040

www.conwin.com

Description:

The Connor-Winfield B31 is a 2.5 x 2.0 mm, 3.3 V Clipped Sinewave, Surface Mount, Temperature Compensated Crystal Oscillator (TCXO), designed for applications requiring tight frequency stability in a very small package. The RoHS compliant surface mount package is designed for high-density mounting and is optimum for mass production.

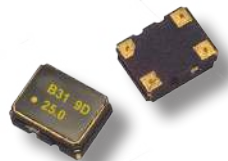

Features:

- 3.3 Vdc Operation
- Clipped Sinewave Output
- Frequency Stability: ± 0.50 ppm
- Temperature Range: -30 to 85°C
- Low Jitter: < 1 ps RMS
- 2.5 x 2.0 mm SMT Package
- Tape and Reel Packaging
- RoHS Compliant / Lead Free

Absolute Maximum Ratings

Parameter	Minimum	Nominal	Maximum	Units	Notes
Storage Temperature	-55	-	85	$^{\circ}\text{C}$	
Supply Voltage (Vcc)	-0.5	-	6.0	Vdc	

Operating Specifications

Parameter	Minimum	Nominal	Maximum	Units	Notes
Center Frequency: (Fo)	10.0	-	50.0	MHz	
Frequency Calibration @ 25°C	-1.0	-	1.0	ppm	1
Frequency Stability					
Vs. Temperature:	-0.50	-	0.50	ppm	2
VS. Supply Voltage:	-0.2	-	0.2	ppm	$\pm 5\%$
VS. Load:	-0.2	-	0.2	ppm	$\pm 5\%$
Static Temperature Hysteresis:	-	-	0.40	ppm	Absolute, 3
Aging per Year	-1.0	-	1.0	ppm	
Freq. Shift Due to Solder Reflow:	-1.0	-	1.0	ppm	4
Operating Temperature Range:	-30	-	85	$^{\circ}\text{C}$	
Supply Voltage (Vcc) $\pm 5\%$	3.135	3.3	3.465	Vdc	
Supply Current (Icc)	-	-	2.0	mA	
Period Jitter	-	3	5	ps rms	
Integrated Phase Jitter	-	0.5	1.0	ps rms	5
SSB Phase Noise at 10Hz offset	-	-80	-	dBc/Hz	
SSB Phase Noise at 100Hz offset	-	-110	-	dBc/Hz	
SSB Phase Noise at 1KHz offset	-	-130	-	dBc/Hz	
SSB Phase Noise at 10KHz offset	-	-145	-	dBc/Hz	
SSB Phase Noise at 100KHz offset	-	-145	-	dBc/Hz	
Start-up Time	-	-	5	ms	

Clipped Sinewave Output Characteristics

Parameter	Minimum	Nominal	Maximum	Units	Notes
Load (CL)	-	10 pF // 10 KOhm	-		6
Output Voltage	0.8	-	-	V pk to pk	7

Package Characteristics

Package Hermetically sealed ceramic package and metal cover

Ordering Information

B31-020.0M, B31-025.0M, B31-040.0M

Environmental Characteristics

Vibration: Vibration per Mil Std 883E Method 2007.3 Test Condition A
 Shock: Mechanical Shock per Mil Std 883E Method 2002.4 Test Condition B.
 Soldering Process: RoHS compliant lead free. See soldering profile on page 2.

Notes:

1. Initial calibration @ 25°C . Specifications at time of shipment after 48 hours of operation.
2. Frequency stability vs. change in temperature. $[\pm(F_{\text{max}} - F_{\text{min}})/2.F_0]$.
3. Frequency change after reciprocal temperature ramped over the operating range. Frequency measured before and after at 25°C .
4. Within two hours after reflow
5. BW = 12 KHz to 20 MHz.
6. Output is DC coupled. Load capacitor, load resistor, coupling capacitor and by pass capacitors are required components to insure proper operation of this TCXO.
7. For best performance it is recommended that the circuit connected to this output should have an equivalent input capacitance of 10pF.





Package Layout

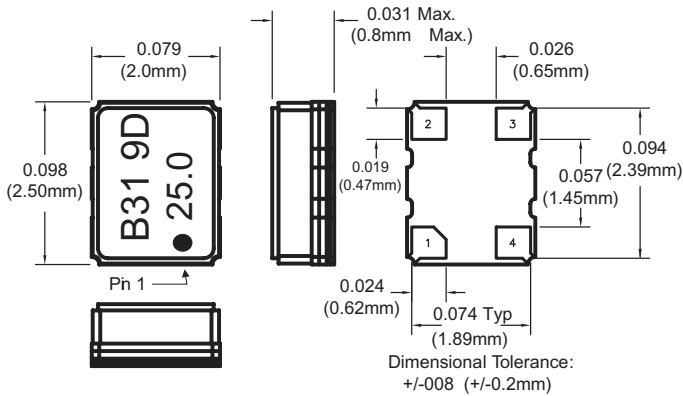

Pad Connections

- 1: No Connection
- 2: Ground
- 3: Output
- 4: Supply Voltage (Vcc)

2 CHARACTER DATE CODE

Y = Year	M = Month
9 = 2019	A = January
0 = 2020	B = February
1 = 2021	C = March
2 = 2022	D = April
	E = May
	F = June
	G = July
	H = August
	J = September
	K = October
	M = November
	N = December

Suggested Pad Layout

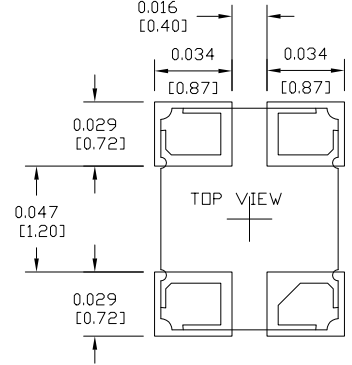

Output Waveform

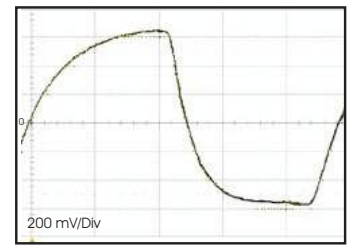

Typical Phase Noise Plot

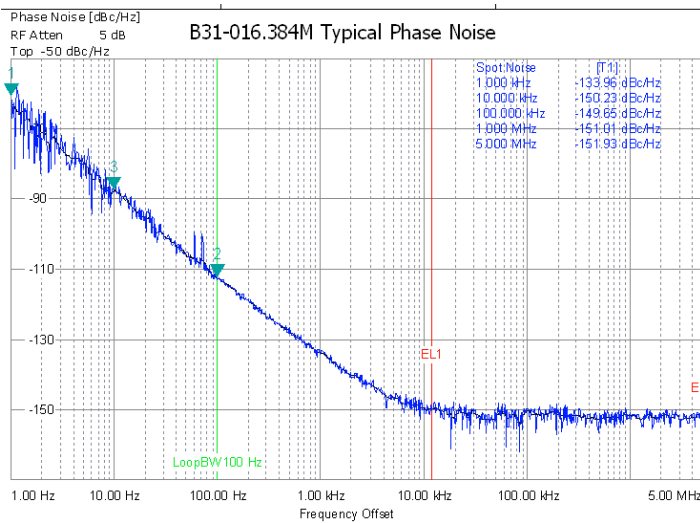

Test Circuit

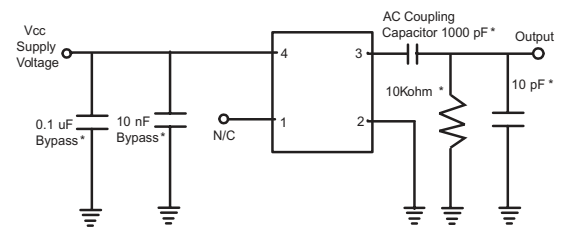

* Required components to insure proper operation.

Tape and Reel Information

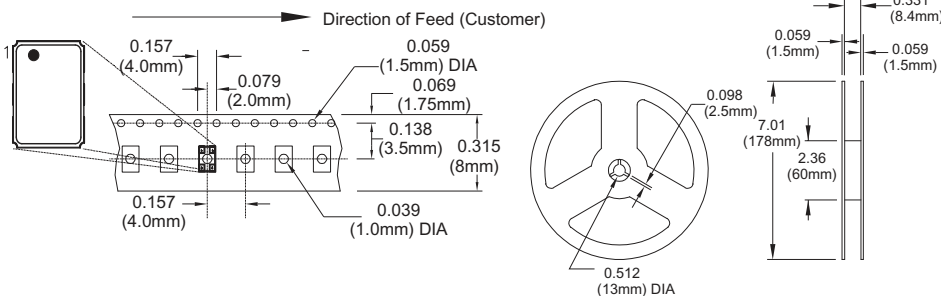

Solder Profile

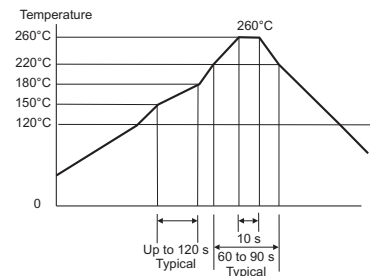

Meets IPC/JEDEC J-STD-020C

Bulletin	TX415
Page	2 of 2
Revision	03
Date	31 Dec 2019