

MOSFET - Single N-Channel

150 V, 4.1 mΩ, 185 A

NVBGS4D1N15MC



ON Semiconductor®

www.onsemi.com

Features

- Low $R_{DS(on)}$ to Minimize Conduction Losses
- Low Q_G and Capacitance to Minimize Driver Losses
- Lowers Switching Noise/EMI
- AEC-Q101 Qualified and PPAP Capable
- These Devices are Pb-Free, Halogen Free/BFR Free and are RoHS Compliant

Typical Applications

- Power Tools, Battery Operated Vacuums
- UAV/Drones, Material Handling
- BMS/Storage, Home Automation

MAXIMUM RATINGS ($T_J = 25^\circ\text{C}$ unless otherwise noted)

Parameter	Symbol	Value	Unit
Drain-to-Source Voltage	V_{DSS}	150	V
Gate-to-Source Voltage	V_{GS}	± 20	V
Continuous Drain Current $R_{\theta JC}$ (Note 2)	I_D	185	A
Power Dissipation $R_{\theta JC}$ (Note 2)			
Continuous Drain Current $R_{\theta JA}$ (Notes 1, 2)	I_D	20	A
Power Dissipation $R_{\theta JA}$ (Notes 1, 2)			
Pulsed Drain Current	I_{DM}	2564	A
Operating Junction and Storage Temperature Range	T_J, T_{stg}	-55 to +175	$^\circ\text{C}$
Source Current (Body Diode)	I_S	263	A
Single Pulse Drain-to-Source Avalanche Energy ($I_L = 81.5 A_{pk}, L = 0.1 \text{ mH}$)	E_{AS}	332	mJ
Lead Temperature for Soldering Purposes (1/8" from case for 10 s)	T_L	260	$^\circ\text{C}$

Stresses exceeding those listed in the Maximum Ratings table may damage the device. If any of these limits are exceeded, device functionality should not be assumed, damage may occur and reliability may be affected.

1. Surface-mounted on FR4 board using a 1 in², 1 oz. Cu pad.
2. The entire application environment impacts the thermal resistance values shown, they are not constants and are only valid for the particular conditions noted.

$V_{(BR)DSS}$	$R_{DS(ON)} \text{ MAX}$	$I_D \text{ MAX}$
150 V	4.1 mΩ @ 10 V	185 A
	4.7 mΩ @ 8 V	

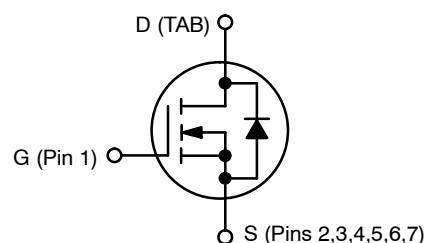

N-CHANNEL MOSFET

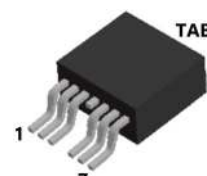

D²PAK7
CASE 418AY

MARKING DIAGRAM

XXXXXXXXXX
AYWWG

XXXX = Specific Device Code
A = Assembly Location
Y = Year
WW = Work Week
G = Pb-Free Package

ORDERING INFORMATION

Device	Package	Shipping [†]
NVBGS4D1N15MC	D ² PAK7 (Pb-Free)	800 / Tape & Reel

[†]For information on tape and reel specifications, including part orientation and tape sizes, please refer to our Tape and Reel Packaging Specifications Brochure, BRD8011/D.

NVBGS4D1N15MC

THERMAL RESISTANCE MAXIMUM RATINGS

Parameter	Symbol	Value	Unit
Junction-to-Case – Steady State (Note 2)	$R_{\theta JC}$	0.5	°C/W
Junction-to-Ambient – Steady State (Note 2)	$R_{\theta JA}$	40	

ELECTRICAL CHARACTERISTICS ($T_J = 25^\circ\text{C}$ unless otherwise specified)

Parameter	Symbol	Test Condition	Min	Typ	Max	Unit
-----------	--------	----------------	-----	-----	-----	------

OFF CHARACTERISTICS

Drain-to-Source Breakdown Voltage	$V_{(BR)DSS}$	$V_{GS} = 0\text{ V}, I_D = 250\ \mu\text{A}$	150			V
Drain-to-Source Breakdown Voltage Temperature Coefficient	$V_{(BR)DSS}/T_J$	$I_D = 250\ \mu\text{A}$, referenced to 25°C		20.28		mV/°C
Zero Gate Voltage Drain Current	I_{DSS}	$V_{GS} = 0\text{ V}, V_{DS} = 120\text{ V}$	$T_J = 25^\circ\text{C}$		1	μA
			$T_J = 125^\circ\text{C}$		10	μA
Gate-to-Source Leakage Current	I_{GSS}	$V_{GS} = \pm 20\text{ V}, V_{DS} = 0\text{ V}$			± 100	nA

ON CHARACTERISTICS (Note 3)

Gate Threshold Voltage	$V_{GS(TH)}$	$V_{GS} = V_{DS}, I_D = 574\ \mu\text{A}$	2.5	3.5	4.5	V
Negative Threshold Temperature Coefficient	$V_{GS(TH)}/T_J$	$I_D = 250\ \mu\text{A}$, referenced to 25°C		-10.21		mV/°C
Drain-to-Source On Resistance	$R_{DS(on)}$	$V_{GS} = 10\text{ V}, I_D = 104\text{ A}$		3.3	4.1	m Ω
		$V_{GS} = 8\text{ V}, I_D = 52\text{ A}$		3.5	4.7	
Forward Transconductance	g_{FS}	$V_{DS} = 5\text{ V}, I_D = 90\text{ A}$		10.9		S
Gate-Resistance	R_G	$T_A = 25^\circ\text{C}$		1.2		Ω

CHARGES & CAPACITANCES

Input Capacitance	C_{ISS}	$V_{GS} = 0\text{ V}, f = 1\text{ MHz}, V_{DS} = 75\text{ V}$		7285		pF
Output Capacitance	C_{OSS}			2025		
Reverse Transfer Capacitance	C_{RSS}			10.6		
Total Gate Charge	$Q_{G(TOT)}$	$V_{GS} = 10\text{ V}, V_{DS} = 75\text{ V}, I_D = 104\text{ A}$		88.9		nC
Threshold Gate Charge	$Q_{G(TH)}$			22.8		
Gate-to-Source Charge	Q_{GS}			37.5		
Gate-to-Drain Charge	Q_{GD}			13.0		
Output Charge	Q_{OSS}	$V_{GS} = 0\text{ V}, V_{DS} = 75\text{ V}$		272		nC

SWITCHING CHARACTERISTICS, $V_{GS} = 10\text{ V}$ (Note 3)

Turn-On Delay Time	$t_{d(ON)}$	$V_{GS} = 10\text{ V}, V_{DS} = 75\text{ V}, I_D = 104\text{ A}, R_G = 6\ \Omega$		49		ns
Rise Time	t_r			38		
Turn-Off Delay Time	$t_{d(OFF)}$			64		
Fall Time	t_f			10		

DRAIN-SOURCE DIODE CHARACTERISTICS

Forward Diode Voltage	V_{SD}	$V_{GS} = 0\text{ V}, I_S = 104\text{ A}, T_J = 25^\circ\text{C}$		0.88	1.2	V
		$V_{GS} = 0\text{ V}, I_S = 104\text{ A}, T_J = 125^\circ\text{C}$		0.79		
Reverse Recovery Time	t_{RR}	$V_{GS} = 0\text{ V}, I_S = 104\text{ A}, di_S/dt = 100\text{ A}/\mu\text{s}$		89		ns
Charge Time	t_a			47		
Discharge Time	t_b			42		
Reverse Recovery Charge	Q_{RR}			164		

Product parametric performance is indicated in the Electrical Characteristics for the listed test conditions, unless otherwise noted. Product performance may not be indicated by the Electrical Characteristics if operated under different conditions.

3. Switching characteristics are independent of operating junction temperature

NVBGS4D1N15MC

TYPICAL CHARACTERISTICS

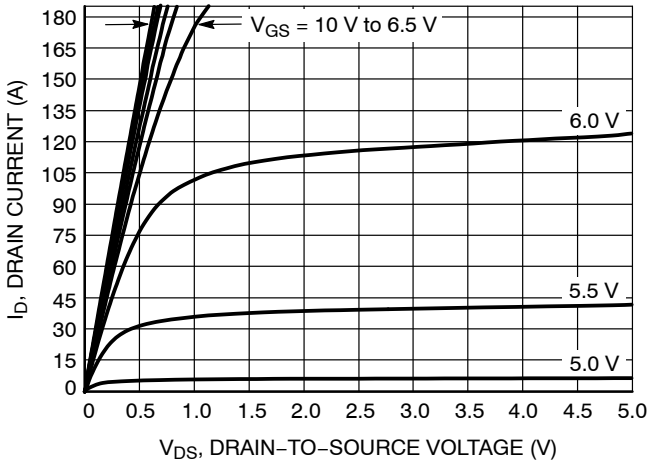

Figure 1. On-Region Characteristics

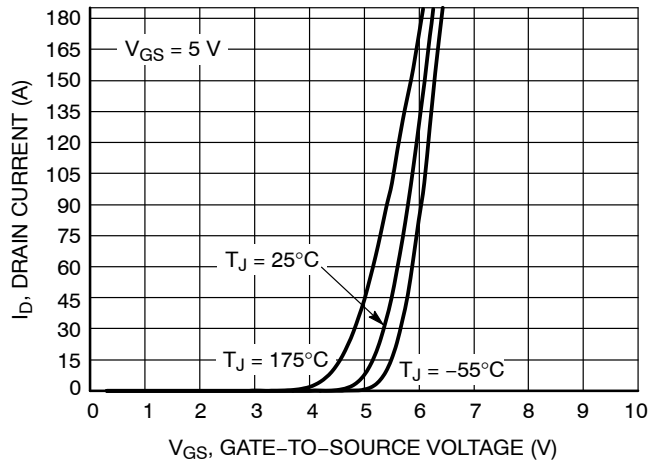

Figure 2. Transfer Characteristics

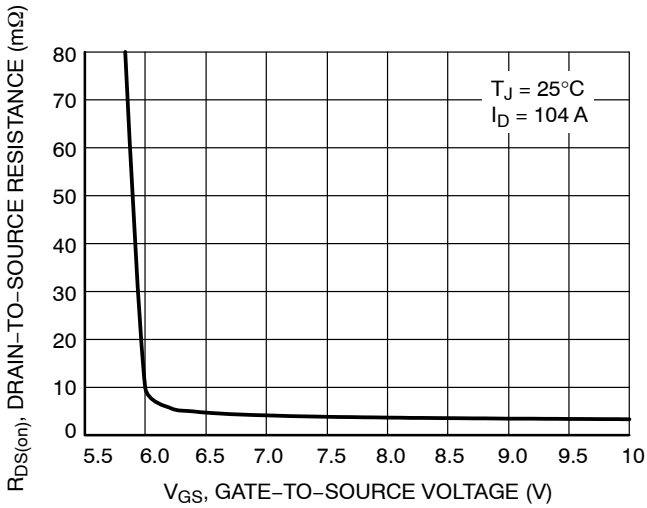

Figure 3. On-Resistance vs. Gate-to-Source Voltage

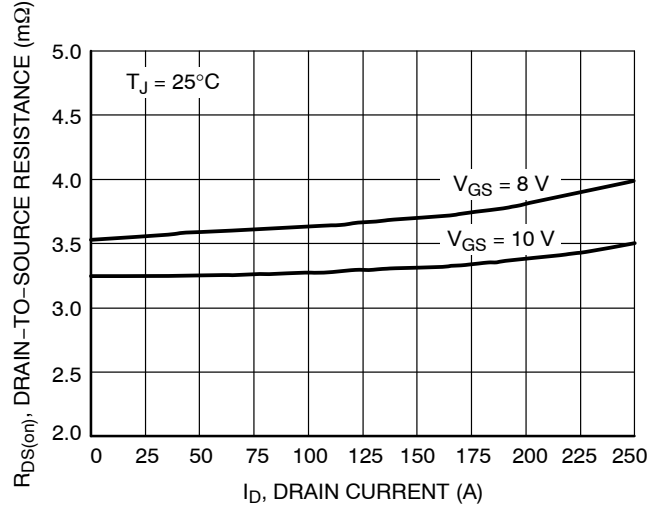

Figure 4. On-Resistance vs. Drain Current and Gate Voltage

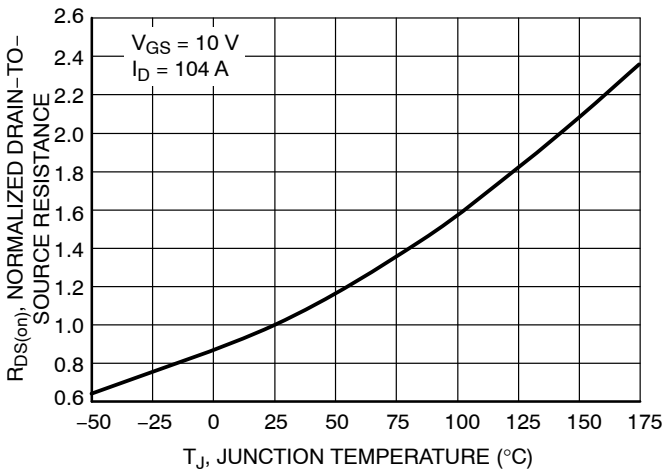

Figure 5. On-Resistance Variation with Temperature

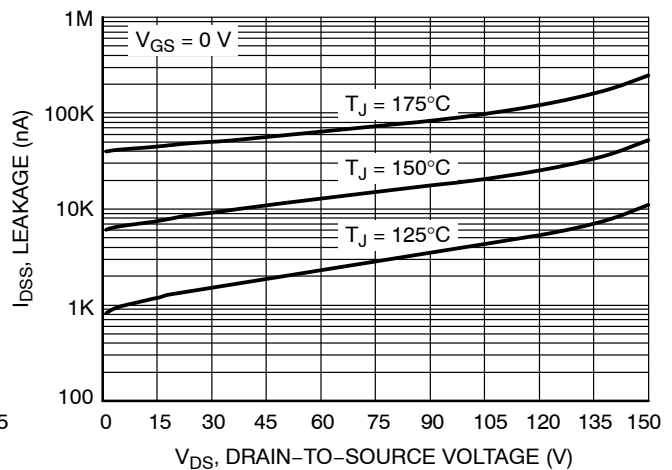

Figure 6. Drain-to-Source Leakage Current vs. Voltage

NVBGS4D1N15MC

TYPICAL CHARACTERISTICS

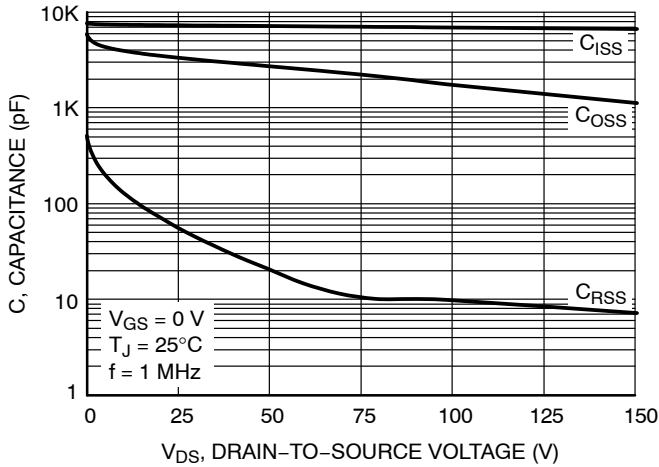

Figure 7. Capacitance Variation

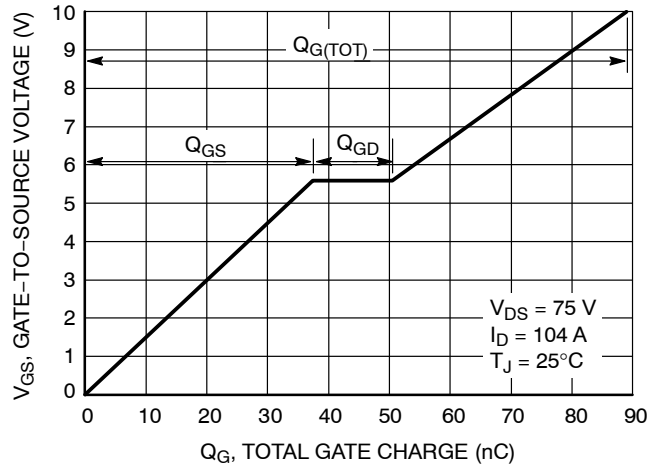

Figure 8. Gate-to-Source Voltage vs. Total Charge

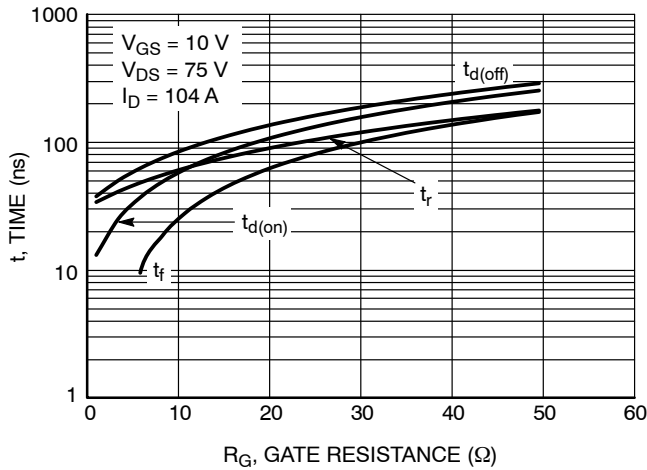

Figure 9. Resistive Switching Time Variation vs. Gate Resistance

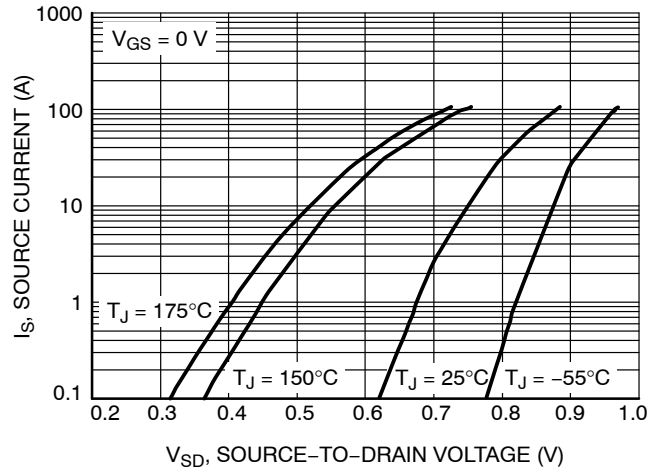

Figure 10. Diode Forward Voltage vs. Current

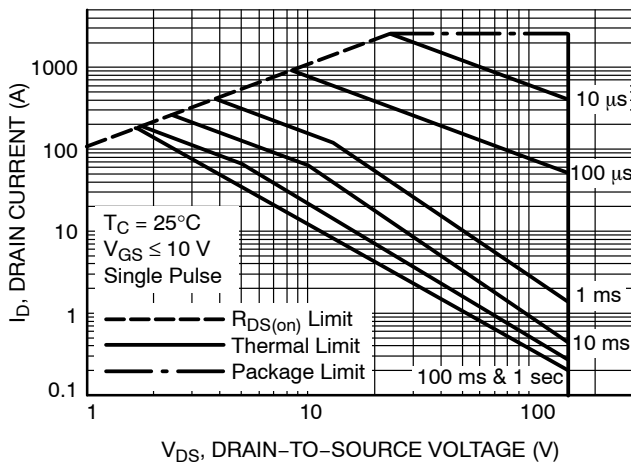

Figure 11. Maximum Rated Forward Biased Safe Operating Area

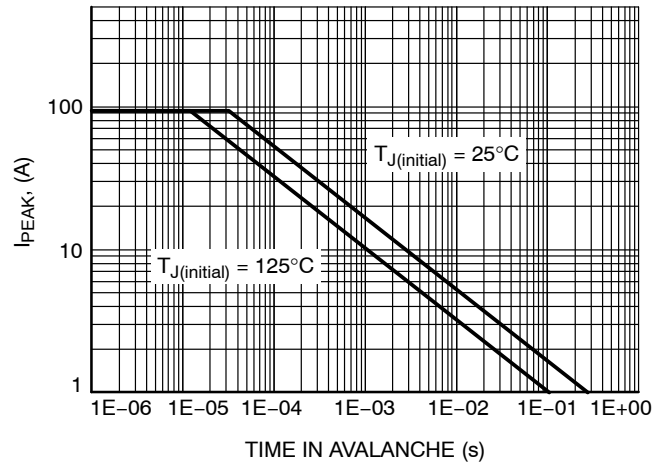

Figure 12. Maximum Drain Current vs. Time in Avalanche

NVBGS4D1N15MC

TYPICAL CHARACTERISTICS

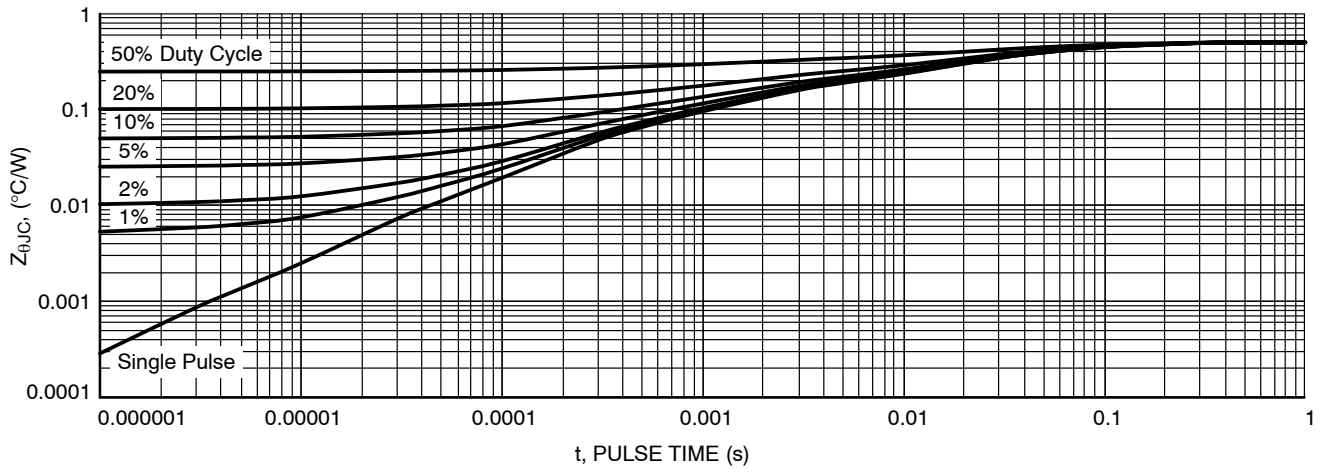

Figure 13. Thermal Response

MECHANICAL CASE OUTLINE

PACKAGE DIMENSIONS

ON Semiconductor®



D2PAK7 (TO-263 7 LD) CASE 418AY ISSUE C

DATE 15 JUL 2019

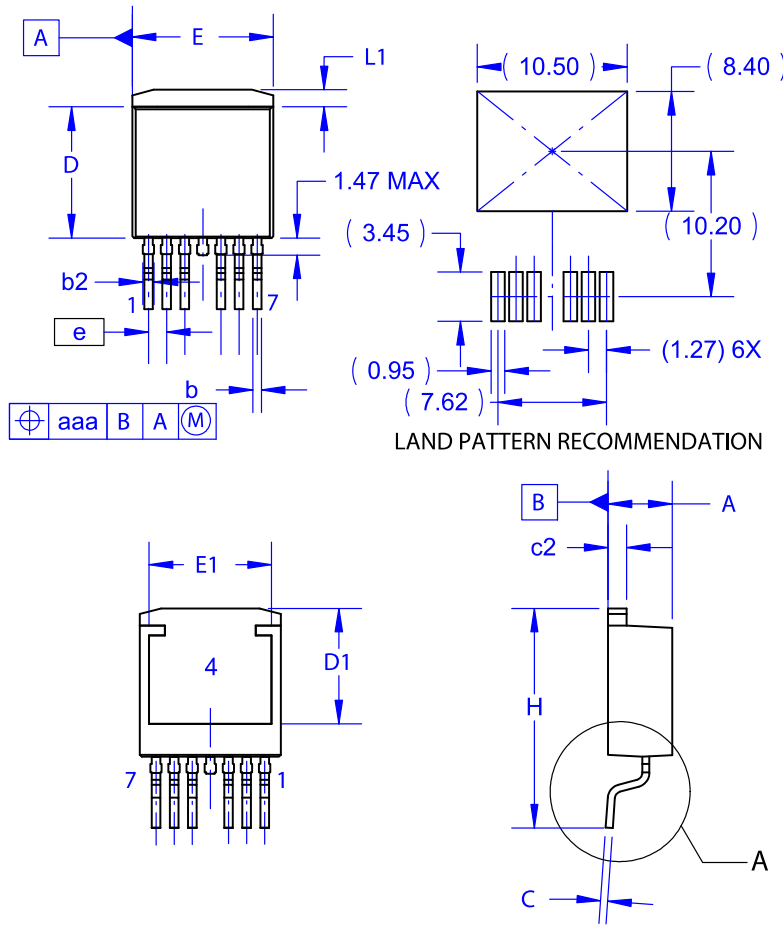

NOTES:

- A. PACKAGE CONFORMS TO JEDEC TO-263 VARIATION CB EXCEPT WHERE NOTED.
- B. ALL DIMENSIONS ARE IN MILLIMETERS.
- C. OUT OF JEDEC STANDARD VALUE.
- D. DIMENSION AND TOLERANCE AS PER ASME Y14.5-1994.
- E. DIMENSIONS ARE EXCLUSIVE OF BURRS, MOLD FLASH AND TIE BAR PROTRUSIONS.
- F. LAND PATTERN RECOMMENDATION PER IPC-TO127P1524X465-8N.

DIM	MILLIMETERS		
	MIN	NOM	MAX
A	4.30	4.50	4.70
A1	0.00	0.10	0.20
b2	0.70	0.80	0.90
b	0.50	0.60	0.70
c	0.40	0.50	0.60
c2	1.20	1.30	1.40
D	9.00	9.20	9.40
D1	7.70	~	~
E	9.70	9.90	10.20
E1	8.38	8.58	8.78
e	~	1.27	~
H	15.10	15.40	15.70
L	2.44	2.64	2.84
L1	1.00	1.20	1.40
L3	~	0.25	~
aaa	~	~	0.25

GENERIC MARKING DIAGRAM*

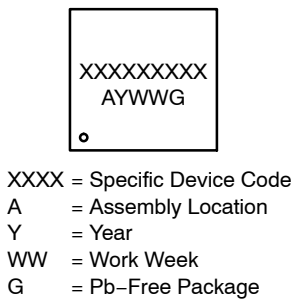

*This information is generic. Please refer to device data sheet for actual part marking. Pb-Free indicator, "G" or microdot "▪", may or may not be present. Some products may not follow the Generic Marking.

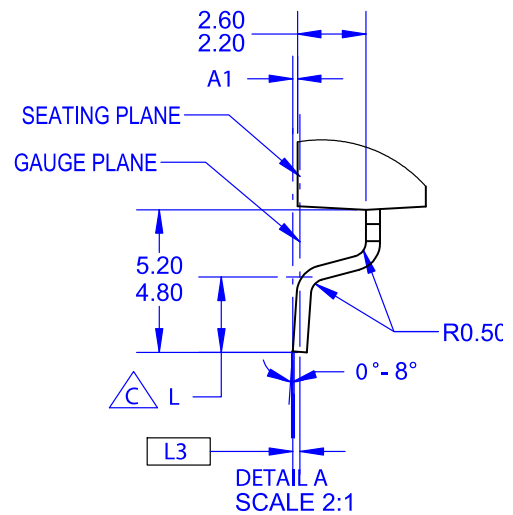

DOCUMENT NUMBER:	98AON13798G	Electronic versions are uncontrolled except when accessed directly from the Document Repository. Printed versions are uncontrolled except when stamped "CONTROLLED COPY" in red.
DESCRIPTION:	D2PAK7 (TO-263 7 LD)	PAGE 1 OF 1

ON Semiconductor and ON are trademarks of Semiconductor Components Industries, LLC dba ON Semiconductor or its subsidiaries in the United States and/or other countries. ON Semiconductor reserves the right to make changes without further notice to any products herein. ON Semiconductor makes no warranty, representation or guarantee regarding the suitability of its products for any particular purpose, nor does ON Semiconductor assume any liability arising out of the application or use of any product or circuit, and specifically disclaims any and all liability, including without limitation special, consequential or incidental damages. ON Semiconductor does not convey any license under its patent rights nor the rights of others.

onsemi, **Onsemi**, and other names, marks, and brands are registered and/or common law trademarks of Semiconductor Components Industries, LLC dba "**onsemi**" or its affiliates and/or subsidiaries in the United States and/or other countries. **onsemi** owns the rights to a number of patents, trademarks, copyrights, trade secrets, and other intellectual property. A listing of **onsemi**'s product/patent coverage may be accessed at www.onsemi.com/site/pdf/Patent-Marking.pdf. **onsemi** reserves the right to make changes at any time to any products or information herein, without notice. The information herein is provided "as-is" and **onsemi** makes no warranty, representation or guarantee regarding the accuracy of the information, product features, availability, functionality, or suitability of its products for any particular purpose, nor does **onsemi** assume any liability arising out of the application or use of any product or circuit, and specifically disclaims any and all liability, including without limitation special, consequential or incidental damages. Buyer is responsible for its products and applications using **onsemi** products, including compliance with all laws, regulations and safety requirements or standards, regardless of any support or applications information provided by **onsemi**. "Typical" parameters which may be provided in **onsemi** data sheets and/or specifications can and do vary in different applications and actual performance may vary over time. All operating parameters, including "Typicals" must be validated for each customer application by customer's technical experts. **onsemi** does not convey any license under any of its intellectual property rights nor the rights of others. **onsemi** products are not designed, intended, or authorized for use as a critical component in life support systems or any FDA Class 3 medical devices or medical devices with a same or similar classification in a foreign jurisdiction or any devices intended for implantation in the human body. Should Buyer purchase or use **onsemi** products for any such unintended or unauthorized application, Buyer shall indemnify and hold **onsemi** and its officers, employees, subsidiaries, affiliates, and distributors harmless against all claims, costs, damages, and expenses, and reasonable attorney fees arising out of, directly or indirectly, any claim of personal injury or death associated with such unintended or unauthorized use, even if such claim alleges that **onsemi** was negligent regarding the design or manufacture of the part. **onsemi** is an Equal Opportunity/Affirmative Action Employer. This literature is subject to all applicable copyright laws and is not for resale in any manner.

ADDITIONAL INFORMATION

TECHNICAL PUBLICATIONS:

Technical Library: www.onsemi.com/design/resources/technical-documentation
onsemi Website: www.onsemi.com

ONLINE SUPPORT: www.onsemi.com/support

For additional information, please contact your local Sales Representative at www.onsemi.com/support/sales