

SPECIFICATION SHEET

SPECIFICATION SHEET NO.	P1105- SMAFSS16FOS106
DATE	Nov. 05, 2022
REVISION	A1
DESCRIPTION	SMD High Efficiency Rectifier, 2 Pads, SMAF series, SS16F Type Reverse Voltage 60V Max. Forward Current 1.0A Max. Operating Temp. Range -50°C ~+150°C Package in Tape/Reel, 3000pcs/Reel RoHS/RoHS III compliant
CUSTOMER	
CUSTOMER PART NUMBER	
CROSS REF. PART NUMBER	
ORIGINAL PART NUMBER	MDD SS16F
PART CODE	SMAFSS16FOS106

VENDOR APPROVE

Issued/Checked/Approved



DATE: Nov. 05, 2022

CUSTOMER APPROVE

DATE:

11/5/2022

SMD HIGH EFFICIENCY RECTIFIER SMAF SERIES



MAIN FEATURE

- The plastic package carries Underwriters Laboratory Flammability Classification 94V-0
- Low reverse leakage
- Built-in strain relief,
- High forward surge current capability
- Ultra fast switching for high efficiency
- High temperature soldering guaranteed: 250°C/ 10 seconds at terminals

APPLICATION

- For printed circuit board

RFQ

[Request For Quotation](#)

PART CODE GUIDE

SMAF	SS16F0	S	106
1	2	3	4

- 1) **SMAF**: SMD High Efficiency Rectifier, 2 Pads, SMAF series
- 2) **SS16F0**: Type code for original part number SS16F
- 3) **S**: Package code, Tape/reel, 3000pcs/reel.
- 4) **106**: Specification code for Reverse Voltage 60V Max. Forward Current 1.0A Max.

MORE ITEMS AVAILABLE

SMAFSS12F0S102	SMAFSS13F0S103	SMAFSS14F0S104	SMAFSS15F0S105	SMAFSS16F0S106
SMAFSS18F0S108	SMAFSS110F0S110	SMAFSS1150S115	SMAFSS1200S120	
SMAFSS22F0S202	SMAFSS23F0S203	SMAFSS24F0S204	SMAFSS25F0S205	SMAFSS26F0S206
SMAFSS28F0S208	SMAFSS210F0S210	SMAFSS2150S215	SMAFSS2200S220	
SMAFSS32F0S302	SMAFSS33F0S303	SMAFSS34F0S304	SMAFSS35F0S305	SMAFSS36F0S306
SMAFSS38F0S308	SMAFSS310F0S310	SMAFSS3150S315	SMAFSS3200S320	
SMAFSS52F0S502	SMAFSS53F0S503	SMAFSS54F0S504	SMAFSS55F0S505	SMAFSS56F0S506
SMAFSS58F0S508	SMAFSS510F0S510	SMAFSS5150S515	SMAFSS5200S520	

11/5/2022

SMD HIGH EFFICIENCY RECTIFIER SMAF SERIES

DIMENSION (Unit: Inch/mm)

Image for reference



Marking: SS16F

SMAF

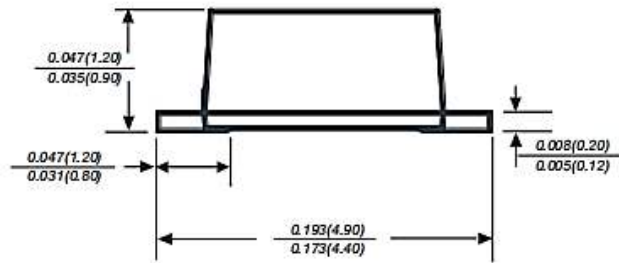
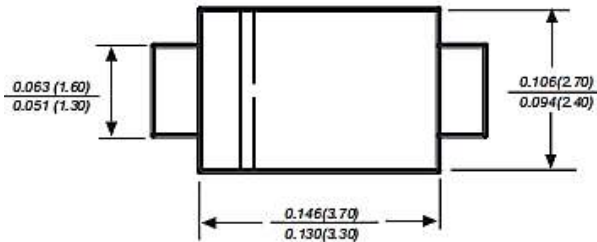

Recommend Pad Layout

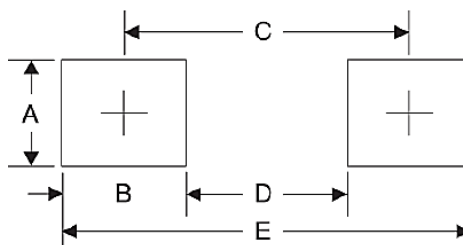

Symbol	Unit (Inch)	Unit (mm)
A	0.071	1.80
B	0.063	1.60
C	0.150	3.80
D	0.087	2.21
E	0.213	5.40

11/5/2022

SMD HIGH EFFICIENCY RECTIFIER SMAF SERIES
MECHANICAL DATA

Case	Terminals	Polarity	Mounting Position	Weight per piece
JEDEC SMAF molded plastic body	Solder plated, Solderable per MIL-STD-750, Method 2026	Color band denotes cathode end	Any	0.00095 Ounce, 0.027 grams

MAX. RATING & CHARACTERISTICS

Parameter	SYMBOLS	VALUE			UNITS
		Min.	Typical	Max.	
Repetitive peak reverse voltage	V _{RRM}			60	Volts
RMS voltage	V _{RMS}			42	Volts
DC blocking voltage	V _{DC}			60	Volts
Average forward output rectified current at TL= 55°C	I _{AV}			1.0	A
Peak forward surge current 8.3ms single half sine-wave superimposed on rated load (JEDEC Method)	I _{FSM}		25		A
Instantaneous forward voltage at 1.0A	V _F			0.70	Volts
DC reverse current at rated DC blocking voltage	I _R	TA=25°C		0.3	mA
		TA=100°C		10.0	
Junction capacitance (Note 3)	C _J		80		pF
Thermal resistance (Note 4)	R _{QJA}		95		°C/W
Operating junction temperature range	T _J	-55		+150	°C
Storage temperature range	T _{STG}	-55		+150	°C

Note

1. Ratings at 25 C ambient temperature unless otherwise specified. Single phase half-wave 60Hz, resistive or inductive load, for capacitive load current derate by 20%.
2. Reverse recovery condition IF=0.5A,IR=1.0A,Irr=0.25A
3. Measured at 1.0MHz and applied reverse voltage of 4.0Voltage
4. P.C.B. mounted with 2.0x2.0"(5.0x5.0cm) copper pad areas.

11/5/2022

SMD HIGH EFFICIENCY RECTIFIER SMAF SERIES
RELIABILITY

Number	Experiment Items	Experiment Method And Conditions	Reference Documents
1	Solder Resistance Test	Test 260°C± 5°C for 10 ± 2 sec. Immerse body into solder 1/16" ± 1/32"	MIL-STD-750D METHOD-2031.2
2	Solderability Test	230°C ±5°C for 5 sec.	MIL-STD-750D METHOD-2026.1 0
3	Pull Test	1 kg in axial lead direction for 10 sec.	MIL-STD-750D METHOD-2036.4
4	Bend Test	0.5Kg Weight Applied To Each Lead, Bending Arcs 90 °C ± 5 °C For 3 Times	MIL-STD-750D METHOD-2036.4
5	High Temperature Reverse Bias Test	TA=100°C for 1000 Hours at VR=80% Rated VR	MIL-STD-750D METHOD-1038.4
6	Forward Operation Life Test	TA=25°C Rated Average Rectified Current	MIL-STD-750D METHOD-1027.3
7	Intermittent Operation Life Test	On state: 5 min with rated IRMS Power Off state: 5 min with Cool Forced Air. On and off for 1000 cycles.	MIL-STD-750D METHOD-1036.3
8	Pressure Cooker Test	15 PSIG, TA=121°C, 4 hours	MIL-S-19500 APPENOIXC
9	Temperature Cycling Test	-55°C~+125°C; 30 Minutes For Dwelled Time 5 minutes for transferred time. Total: 10 cycles.	MIL-STD-750D METHOD-1051.7
10	Thermal Shock Test	0°C for 5 minutes., 100°C for 5minutes, Total: 10 cycles	MIL-STD-750D METHOD-1056.7
11	Forward Surge Test	8.3ms Single Sale Sine-wave One Surge.	MIL-STD-750D METHOD-4066.4
12	Humidity Test	TA=65°C, RH=98% for 1000 hours.	MIL-STD-750D METHOD-1021.3
13	High Temperature Storage life Test	150°C for 1000 Hours	MIL-STD-750D METHOD-1031.5

11/5/2022

SMD HIGH EFFICIENCY RECTIFIER SMAF SERIES

SUGGESTED REFLOW PROFILE (For Reference Only)

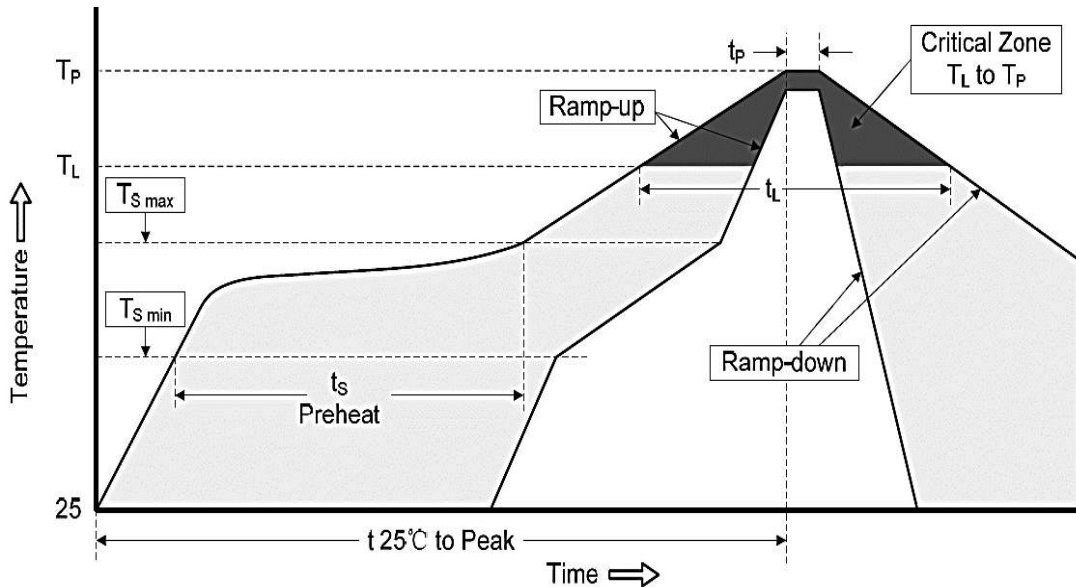

Profile Feature		Pb-Free Assembly
Average Ramp-up Rate (Ts Max to Tp)		3°C/second Max
Preheat	Temperature Min (Ts Min.)	150°C
	Temperature Max (Ts Max.)	200°C
	Time (ts Min. to ts Max.)	60 ~ 180 seconds
Time maintained above	Temperature (Tl)	217°C
	Time (tL)	60 ~ 150 seconds
Peak/Classification Temperature (Tp)		260 °C
Time within 5°C of actual Peak Temperature (tp)		20 ~ 40 seconds
Ramp-down rate		6 °C /Second Max.
Time 25 °C to Peak Temperature		8 minutes Max.
Suggest reflow times		3 Times Max.

SMD HIGH EFFICIENCY RECTIFIER SMAF SERIES

RATINGS AND CHARACTERISTIC CURVES (For Reference Only)

AVERAGE FORWARD RECTIFIED CURRENT, AMPERES

FIG. 1- FORWARD CURRENT DERATING CURVE

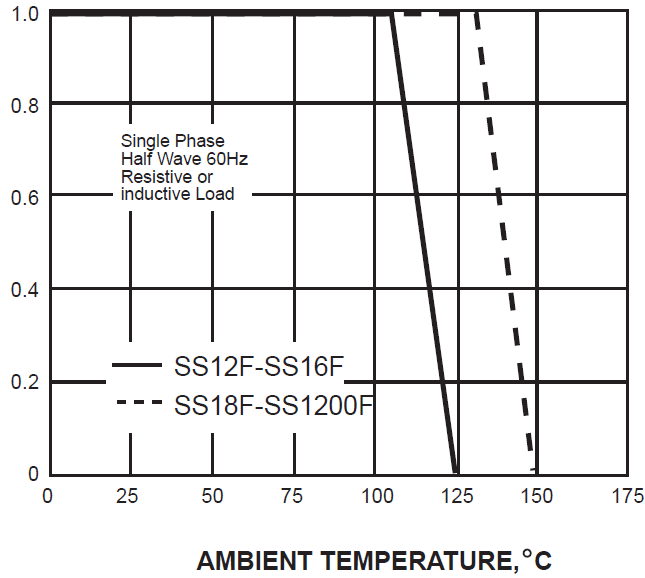

PEAK FORWARD SURGE CURRENT, AMPERES

FIG. 2-MAXIMUM NON-REPETITIVE PEAK FORWARD SURGE CURRENT

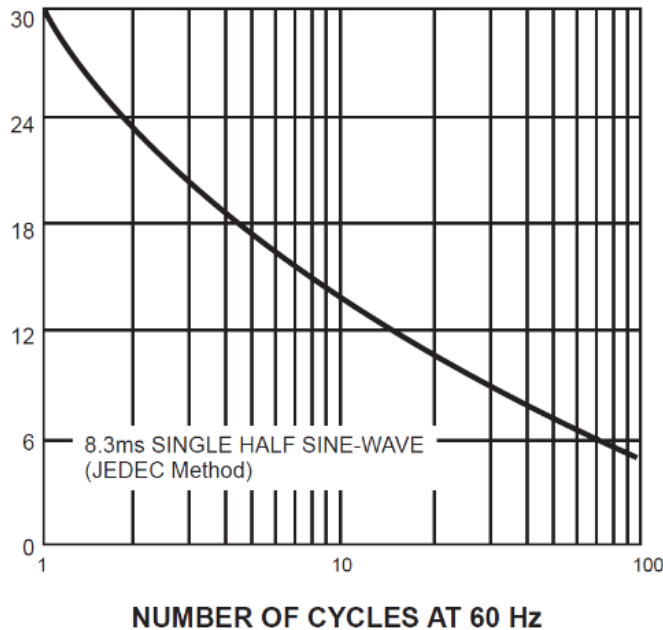

SMD HIGH EFFICIENCY RECTIFIER SMAF SERIES

RATINGS AND CHARACTERISTIC CURVES (For Reference Only)

FIG. 3-TYPICAL INSTANTANEOUS FORWARD CHARACTERISTICS

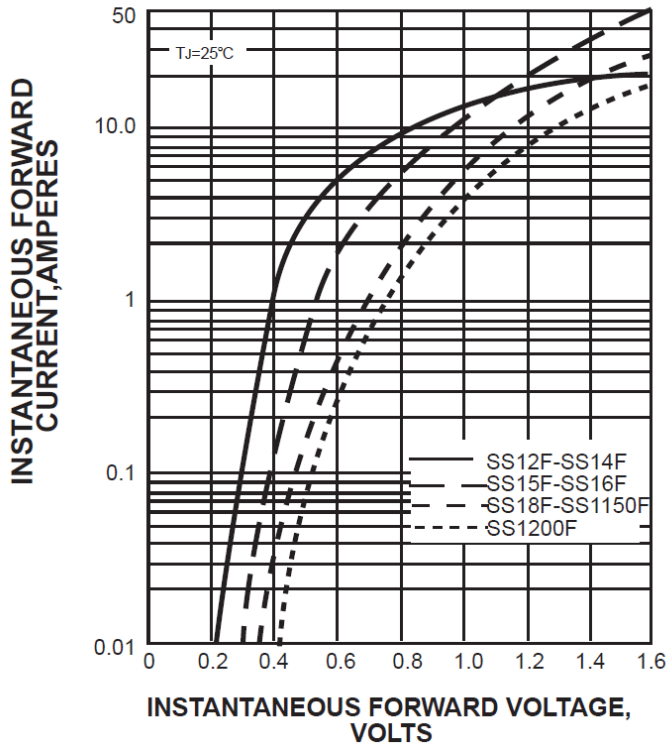
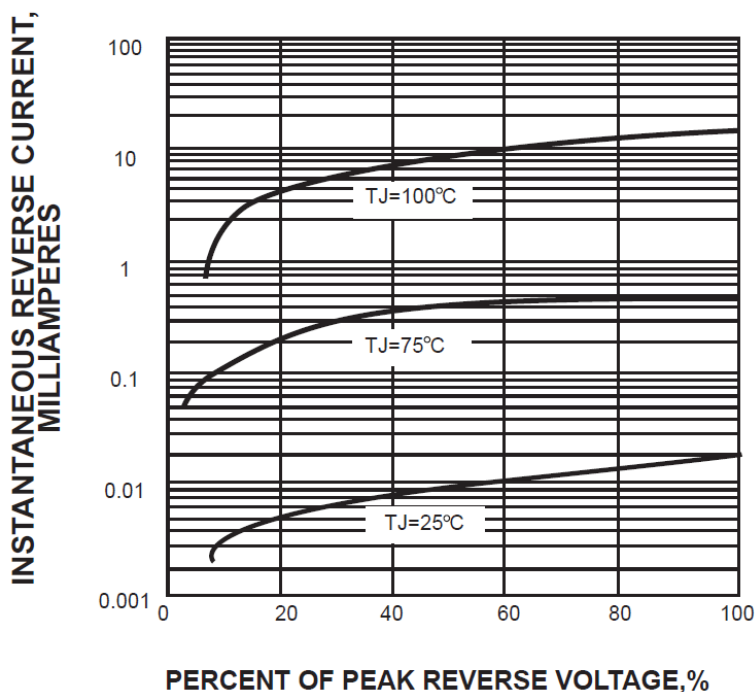

FIG. 4-TYPICAL REVERSE CHARACTERISTICS



SMD HIGH EFFICIENCY RECTIFIER SMAF SERIES

RATINGS AND CHARACTERISTIC CURVES (For Reference Only)

FIG. 5-TYPICAL JUNCTION CAPACITANCE

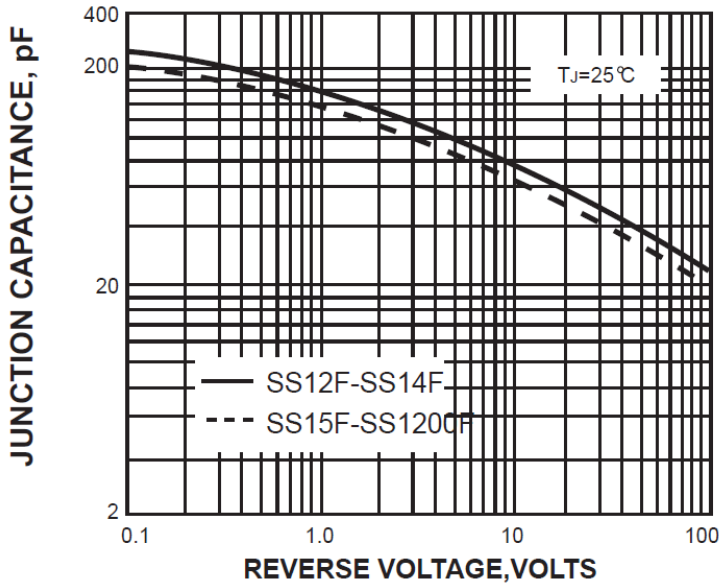
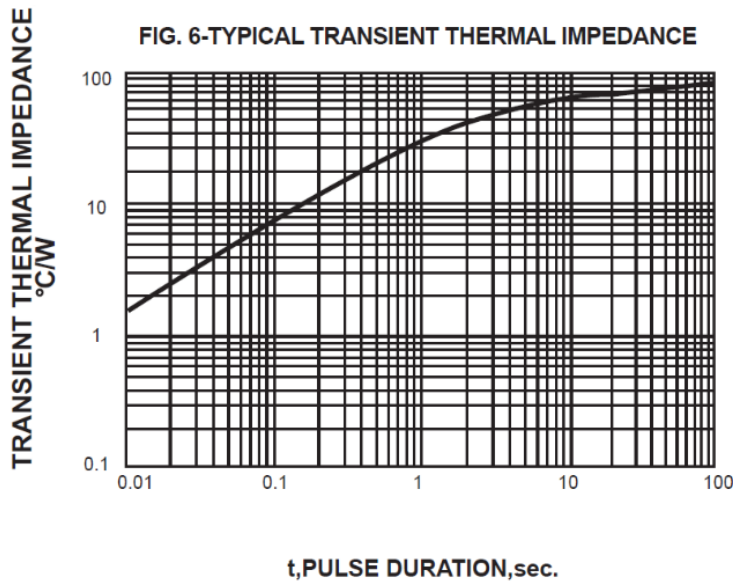

FIG. 6-TYPICAL TRANSIENT THERMAL IMPEDANCE



SMD HIGH EFFICIENCY RECTIFIER SMAF SERIES

TAPE/REEL (Unit: mm)

All Devices are packed in accordance with EIA standard RS-481-A and specifications.

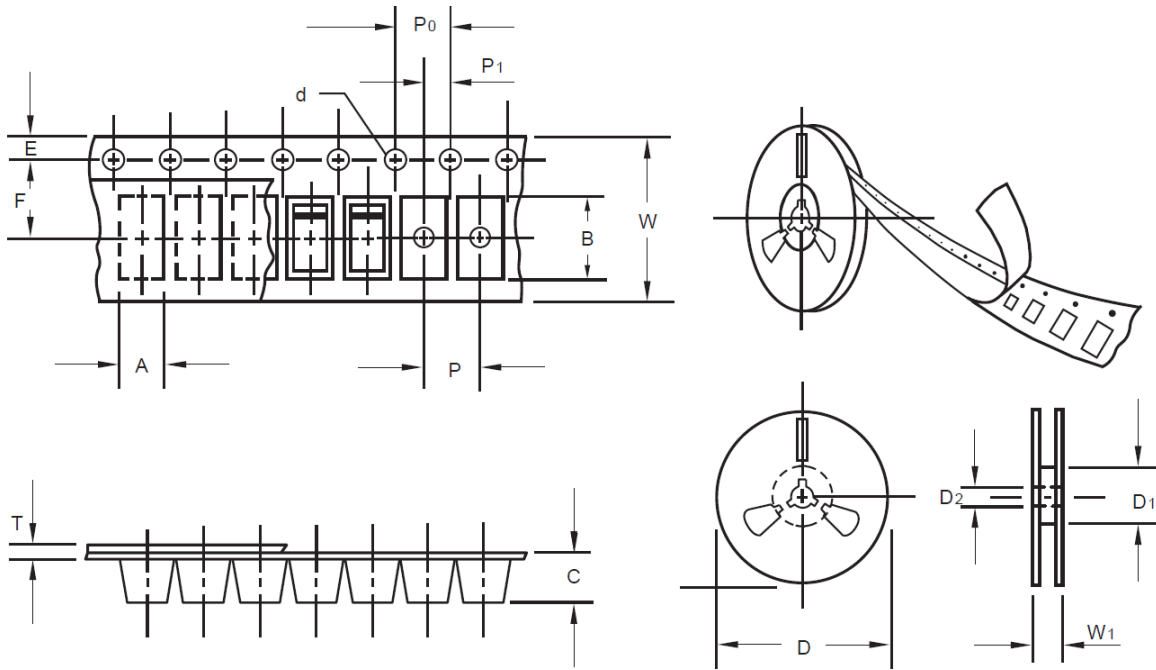

Item	Symbol	Tolerance	SMAF
Carrier width	A	0.1	2.80
Carrier Length	B	0.1	4.75
Carrier Depth	C	0.1	1.42
Sprocket hole	d	0.05	1.50
7" Reel outside diameter	D	2.0	178.00
7" Reel inner diameter	D1	Min.	54.40
Feed hole diameter	D2	0.5	13.00
Sprocket hole position	E	0.1	1.75
Punch hole position	F	0.1	5.05
Punch hole pitch	P	0.1	4.00
Sprocket hole pitch	P0	0.1	4.00
Embossment center	P1	0.1	2.00
Overall tape thickness	T	0.1	0.30
Tape width	W	0.3	8.00
Reel width	W1	1.0	12.30

SMD HIGH EFFICIENCY RECTIFIER SMAF SERIES

PACKAGE For Reference

Case Code	SMAF
Reel Size	7"
Reel Size	178 mm
MPQ/Reel	3000 pcs
Qty. /Box	6000 pcs
G.W/Box	1 lbs

IMPORTANT NOTICE AND DISCLAIMER

- 1) NextGen Component, Inc. reserves the right to make changes to this document and its products and specifications at any time without notice. Customers should obtain and confirm the latest product information and specifications before final design, purchase or use.
- 2) NextGen Component, Inc makes no warranty, representation or guarantee regarding the suitability of its products for any particular purpose, nor does NextGen Component, Inc assume any liability for application assistance or customer product design.
- 3) NextGen Component, Inc does not warrant or accept any liability with products which are purchased or used for any unintended or unauthorized application. No license is granted by implication or otherwise under any intellectual property rights of NextGen Component, Inc
- 4) NextGen Component, Inc. products are not authorized for use as critical components in life support devices or systems without express written approval of NextGen Component, Inc.

11/5/2022