

# ON Semiconductor

## Is Now

# onsemi™

To learn more about onsemi™, please visit our website at  
[www.onsemi.com](http://www.onsemi.com)

---

**onsemi** and **onsemi** and other names, marks, and brands are registered and/or common law trademarks of Semiconductor Components Industries, LLC dba "**onsemi**" or its affiliates and/or subsidiaries in the United States and/or other countries. **onsemi** owns the rights to a number of patents, trademarks, copyrights, trade secrets, and other intellectual property. A listing of **onsemi** product/patent coverage may be accessed at [www.onsemi.com/site/pdf/Patent-Marking.pdf](http://www.onsemi.com/site/pdf/Patent-Marking.pdf). **onsemi** reserves the right to make changes at any time to any products or information herein, without notice. The information herein is provided "as-is" and **onsemi** makes no warranty, representation or guarantee regarding the accuracy of the information, product features, availability, functionality, or suitability of its products for any particular purpose, nor does **onsemi** assume any liability arising out of the application or use of any product or circuit, and specifically disclaims any and all liability, including without limitation special, consequential or incidental damages. Buyer is responsible for its products and applications using **onsemi** products, including compliance with all laws, regulations and safety requirements or standards, regardless of any support or applications information provided by **onsemi**. "Typical" parameters which may be provided in **onsemi** data sheets and/or specifications can and do vary in different applications and actual performance may vary over time. All operating parameters, including "Typicals" must be validated for each customer application by customer's technical experts. **onsemi** does not convey any license under any of its intellectual property rights nor the rights of others. **onsemi** products are not designed, intended, or authorized for use as a critical component in life support systems or any FDA Class 3 medical devices or medical devices with a same or similar classification in a foreign jurisdiction or any devices intended for implantation in the human body. Should Buyer purchase or use **onsemi** products for any such unintended or unauthorized application, Buyer shall indemnify and hold **onsemi** and its officers, employees, subsidiaries, affiliates, and distributors harmless against all claims, costs, damages, and expenses, and reasonable attorney fees arising out of, directly or indirectly, any claim of personal injury or death associated with such unintended or unauthorized use, even if such claim alleges that **onsemi** was negligent regarding the design or manufacture of the part. **onsemi** is an Equal Opportunity/Affirmative Action Employer. This literature is subject to all applicable copyright laws and is not for resale in any manner. Other names and brands may be claimed as the property of others.

# MOSFET - Power, Single N-Channel, Shielded Gate, PowerTrench®

150 V, 31 mΩ, 27 A



ON Semiconductor®

[www.onsemi.com](http://www.onsemi.com)

## NTTFS034N15MC

### Features

- Small Footprint (3.3 x 3.3 mm) for Compact Design
- Low  $R_{DS(on)}$  to Minimize Conduction Losses
- Low Capacitance to Minimize Driver Losses
- These Devices are Pb-Free, Halogen Free/BFR Free and are RoHS Compliant

### Typical Applications

- Primary DC-DC MOSFET
- Synchronous Rectifier in DC-DC and AC-DC
- Motor Drive
- Capable of 175°C Tj Max Rating

### MAXIMUM RATINGS (T<sub>J</sub> = 25°C unless otherwise noted)

Parameter	Symbol	Value	Unit		
Drain-to-Source Voltage	V <sub>DSS</sub>	150	V		
Gate-to-Source Voltage	V <sub>GS</sub>	±20	V		
Continuous Drain Current R <sub>θJC</sub> (Note 5)	Steady State	T <sub>C</sub> = 25°C	I <sub>D</sub>	27	A
		T <sub>C</sub> = 25°C	P <sub>D</sub>	53.6	W
		T <sub>A</sub> = 25°C	I <sub>D</sub>	6.2	A
		T <sub>A</sub> = 25°C	P <sub>D</sub>	2.8	W
		T <sub>A</sub> = 25°C	P <sub>D</sub>	1.2	W
Pulsed Drain Current (Note 3)	T <sub>C</sub> = 25°C	I <sub>DM</sub>	110	A	
Operating Junction and Storage Temperature Range	T <sub>J</sub> , T <sub>stg</sub>	-55 to +175	°C		
Single Pulse Drain-to-Source Avalanche Energy (I <sub>L(pk)</sub> = 6 A) (Note 4)	E <sub>AS</sub>	54	mJ		
Maximum Lead Temperature for Soldering Purposes (1/8" from case for 10 s)	T <sub>L</sub>	260	°C		

Stresses exceeding those listed in the Maximum Ratings table may damage the device. If any of these limits are exceeded, device functionality should not be assumed, damage may occur and reliability may be affected.

1. Surface mounted on a FR-4 board using 1 in<sup>2</sup> pad of 2 oz copper.
2. Surface mounted on a FR-4 board using the minimum recommended pad of 2 oz copper.
3. Pulsed ID please refer to Figure 12 SOA graph for more details
4. E<sub>AS</sub> of 54 mJ is based on starting T<sub>J</sub> = 25°C; L = 3 mH, I<sub>AS</sub> = 6 A, V<sub>DD</sub> = 150 V, V<sub>GS</sub> = 10 V.
5. The entire application environment impacts the thermal resistance values shown, they are not constants and are only valid for the particular conditions noted.

V <sub>(BR)DSS</sub>	R <sub>DS(on)</sub> MAX	I <sub>D</sub> MAX
150 V	31 mΩ @ 10 V	27 A

### N-CHANNEL MOSFET

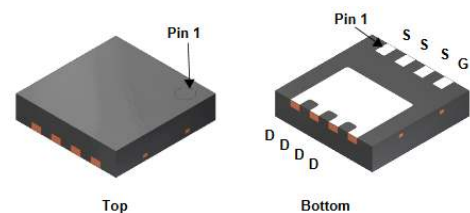
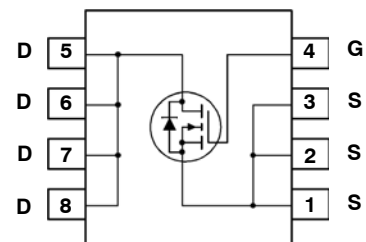

WDFN8  
CASE 483AW

### MARKING DIAGRAM

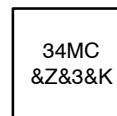

34MC = Specific Device Code  
&Z = Assembly Location  
&3 = 3-Digit Date Code  
&K = Lot Traceability

### ORDERING INFORMATION

Device	Package	Shipping†
NTTFS034N15MC	WDFN8 (Pb-Free)	3000 / Tape & Reel

†For information on tape and reel specifications, including part orientation and tape sizes, please refer to our Tape and Reel Packaging Specification Brochure, BRD8011/D.

# NTTFS034N15MC

## THERMAL CHARACTERISTICS

Parameter	Symbol	Value	Unit
Thermal Resistance Junction-to-Case – Steady State (Note 5)	$R_{\theta JC}$	2.8	$^{\circ}C/W$
Thermal Resistance Junction-to-Ambient – Steady State (Notes 1, 5)	$R_{\theta JA}$	53	$^{\circ}C/W$
Thermal Resistance Junction-to-Ambient – Steady State (Notes 2, 5)	$R_{\theta JA}$	125	$^{\circ}C/W$

## ELECTRICAL CHARACTERISTICS ( $T_J = 25^{\circ}C$ unless otherwise noted)

Parameter	Symbol	Test Condition	Min	Typ	Max	Unit
-----------	--------	----------------	-----	-----	-----	------

### OFF CHARACTERISTICS

Drain-to-Source Breakdown Voltage	$V_{(BR)DSS}$	$V_{GS} = 0 V, I_D = 250 \mu A$	150			V
Drain-to-Source Breakdown Voltage Temperature Coefficient	$V_{(BR)DSS}/T_J$	$I_D = 250 \mu A$ , referenced to $25^{\circ}C$		77		$mV/^{\circ}C$
Zero Gate Voltage Drain Current	$I_{DSS}$	$V_{GS} = 0 V, V_{DS} = 120 V, T_J = 25^{\circ}C$			1	$\mu A$
Gate-to-Source Leakage Current	$I_{GSS}$	$V_{GS} = \pm 20 V, V_{DS} = 0 V$			$\pm 100$	nA

### ON CHARACTERISTICS

Gate Threshold Voltage	$V_{GS(TH)}$	$V_{GS} = V_{DS}, I_D = 70 \mu A$	2.5		4.5	V
Gate Threshold Temperature Coefficient	$V_{GS(TH)}/T_J$	$I_D = 70 \mu A$ , referenced to $25^{\circ}C$		-8.1		$mV/^{\circ}C$
Drain-to-Source On Resistance	$R_{DS(on)}$	$V_{GS} = 10 V, I_D = 13 A$		26	31	$m\Omega$
		$V_{GS} = 8 V, I_D = 6 A$		28.3	36.3	$m\Omega$
Forward Transconductance	$g_{FS}$	$V_{DS} = 10 V, I_D = 13 A$		29		S

### CHARGES, CAPACITANCES & GATE RESISTANCE

Input Capacitance	$C_{ISS}$	$V_{GS} = 0 V, f = 1 MHz$ $V_{DS} = 75 V$		905		pF
Output Capacitance	$C_{OSS}$			270		
Reverse Transfer Capacitance	$C_{RSS}$			5		
Gate-Resistance	$R_G$			0.6	1.2	$\Omega$
Total Gate Charge	$Q_{G(TOT)}$	$V_{GS} = 10 V, V_{DS} = 75 V, I_D = 13 A$		12		nC
Threshold Gate Charge	$Q_{G(TH)}$			3.1		
Gate-to-Source Charge	$Q_{GS}$			4.8		
Gate-to-Drain Charge	$Q_{GD}$			1.8		
Plateau Voltage	$V_{GP}$			5.4		
Output Charge	$Q_{OSS}$	$V_{GS} = 0 V, V_{DD} = 75 V$		32		nC

### RESISTIVE SWITCHING CHARACTERISTICS (Note 6)

Turn-On Delay Time	$t_{d(on)}$	$V_{GS} = 10 V, V_{DS} = 75 V,$ $I_D = 13 A, R_G = 6 \Omega$		12		ns
Rise Time	$t_r$			2.2		
Turn-Off Delay Time	$t_{d(off)}$			14		
Fall Time	$t_f$			2.5		

### DRAIN-SOURCE DIODE CHARACTERISTICS

Forward Diode Voltage	$V_{SD}$	$V_{GS} = 0 V, I_S = 13 A, T_J = 25^{\circ}C$		0.87	1.2	V
Reverse Recovery Time	$t_{RR}$	$V_{GS} = 0 V, V_{DD} = 75 V$ $di_S/dt = 300 A/\mu s, I_S = 13 A$		41		ns
Reverse Recovery Charge	$Q_{RR}$			126		nC
Reverse Recovery Time	$t_{RR}$	$V_{GS} = 0 V, V_{DD} = 75 V$ $di_S/dt = 1000 A/\mu s, I_S = 13 A$		22		ns
Reverse Recovery Charge	$Q_{RR}$			164		nC

Product parametric performance is indicated in the Electrical Characteristics for the listed test conditions, unless otherwise noted. Product performance may not be indicated by the Electrical Characteristics if operated under different conditions.

6. Switching characteristics are independent of operating junction temperature

TYPICAL CHARACTERISTICS

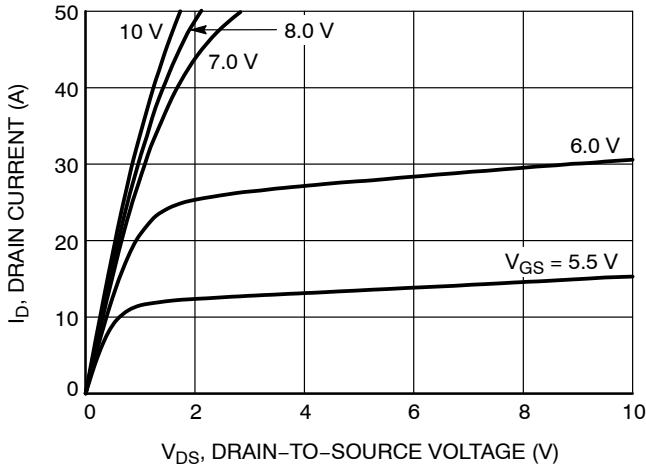

Figure 1. On-Region Characteristics

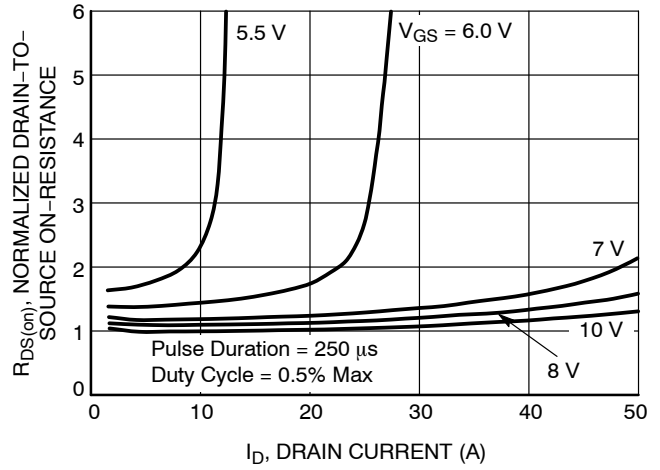

Figure 2. Normalized On-Resistance vs. Drain Current and Gate Voltage

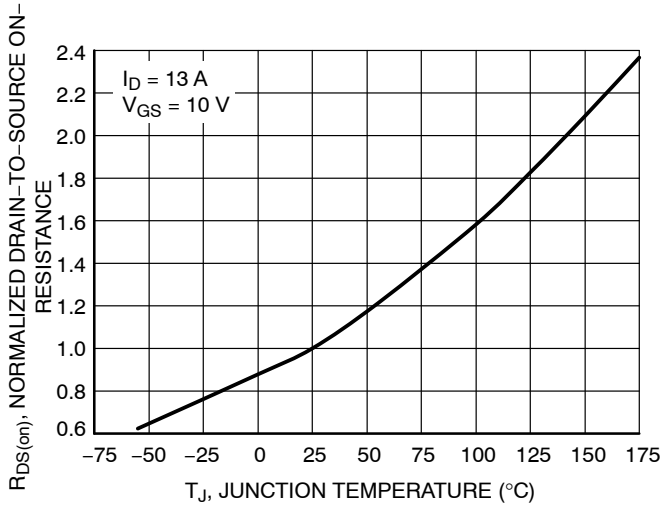

Figure 3. Normalized On-Resistance vs. Junction Temperature

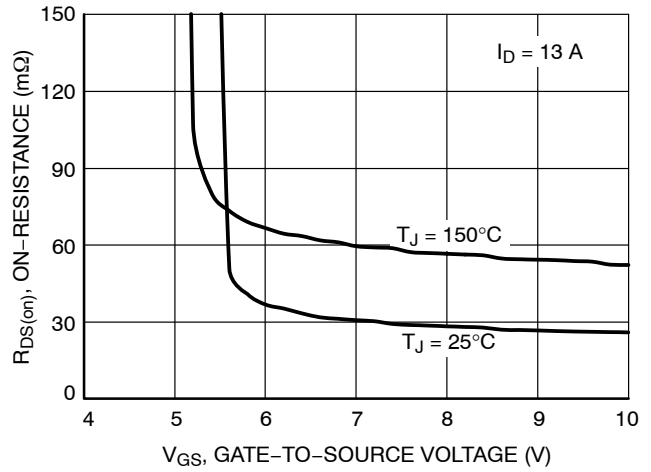

Figure 4. On-Resistance vs. Gate-to-Source Voltage

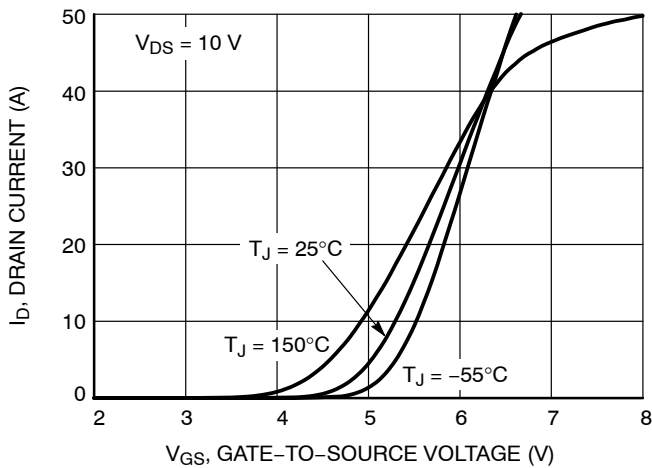

Figure 5. Transfer Characteristics

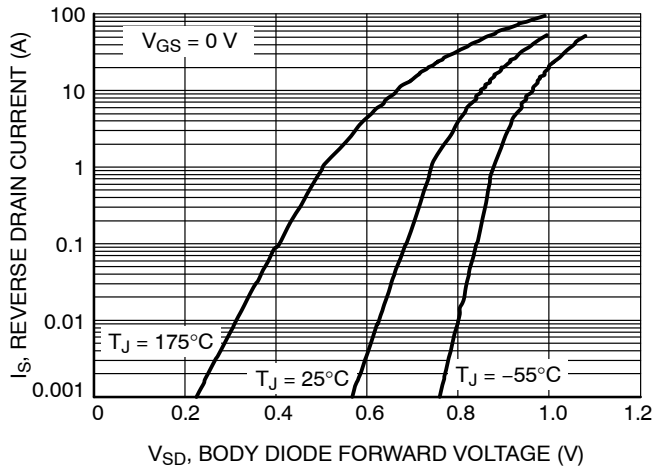

Figure 6. Source-to-Drain Diode Forward Voltage vs. Source Current

# NTTFS034N15MC

## TYPICAL CHARACTERISTICS

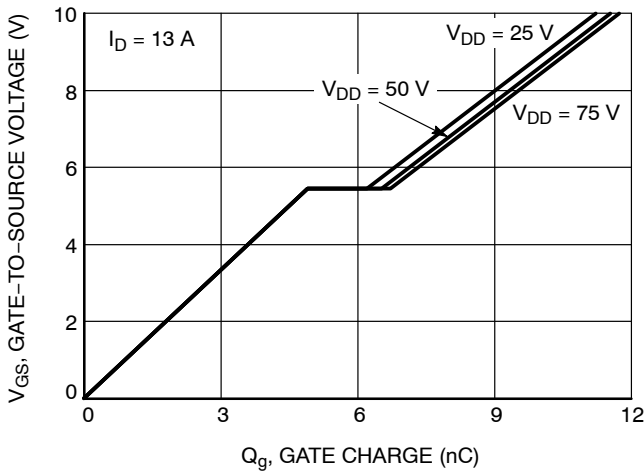

Figure 7. Gate Charge Characteristics

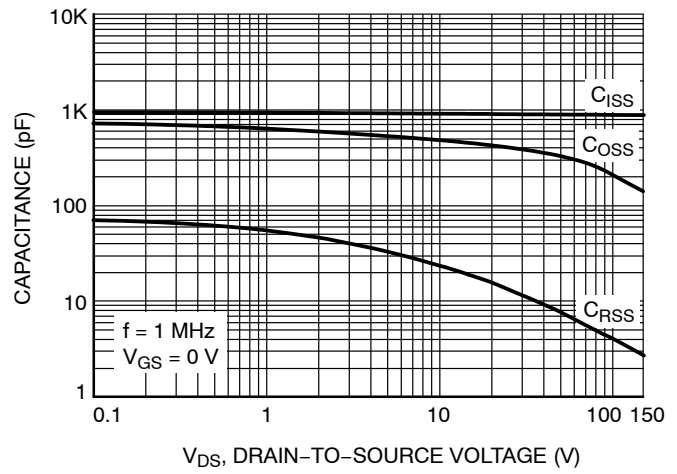

Figure 8. Capacitance vs. Drain-to-Source Voltage

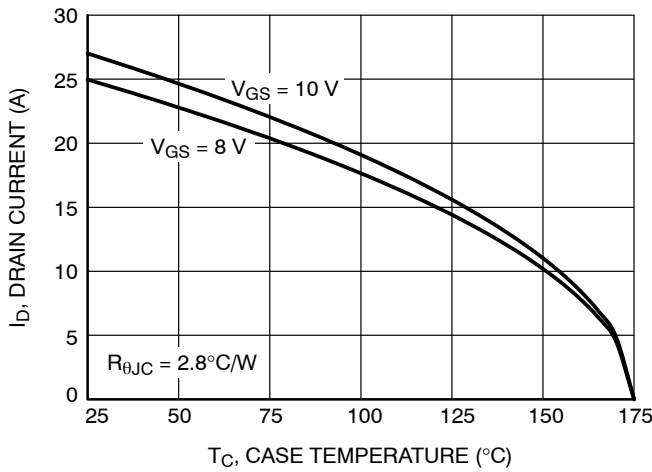

Figure 9. Drain Current vs. Case Temperature

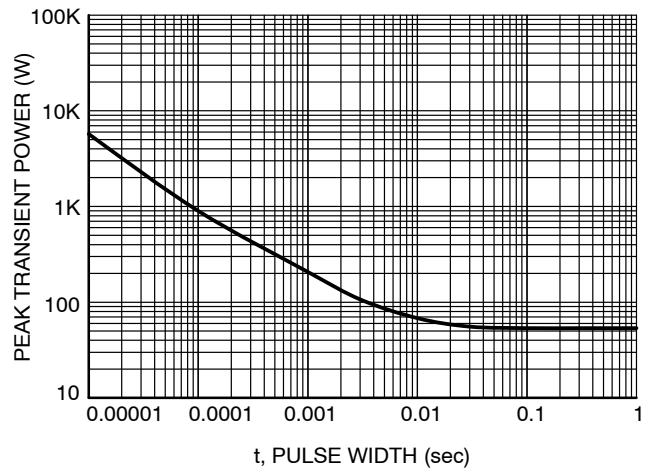

Figure 10. Peak Power

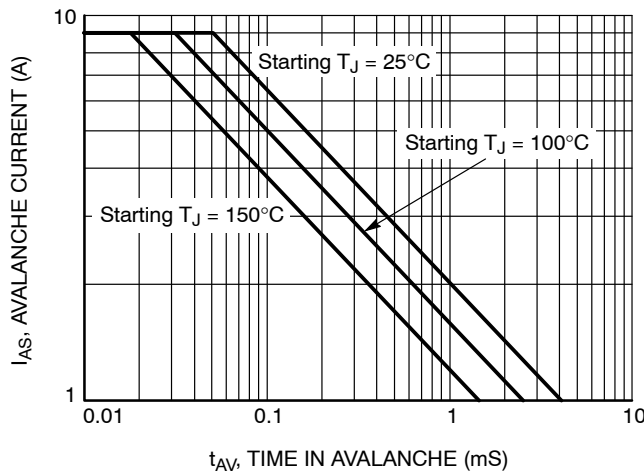

Figure 11. Unclamped Inductive Switching Capability

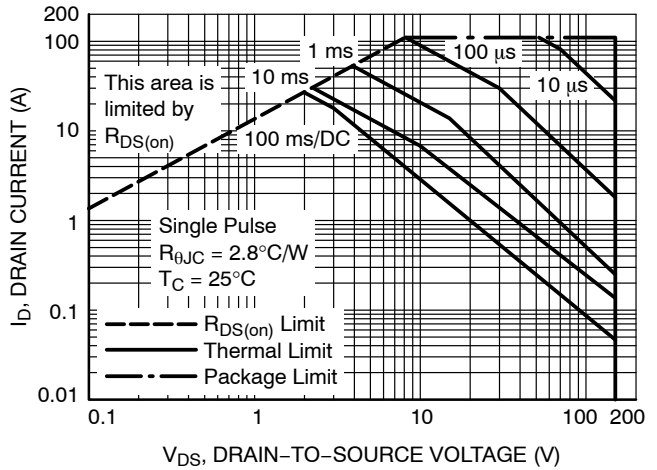

Figure 12. Forward Bias Safe Operating Area

# NTTFS034N15MC

## TYPICAL CHARACTERISTICS

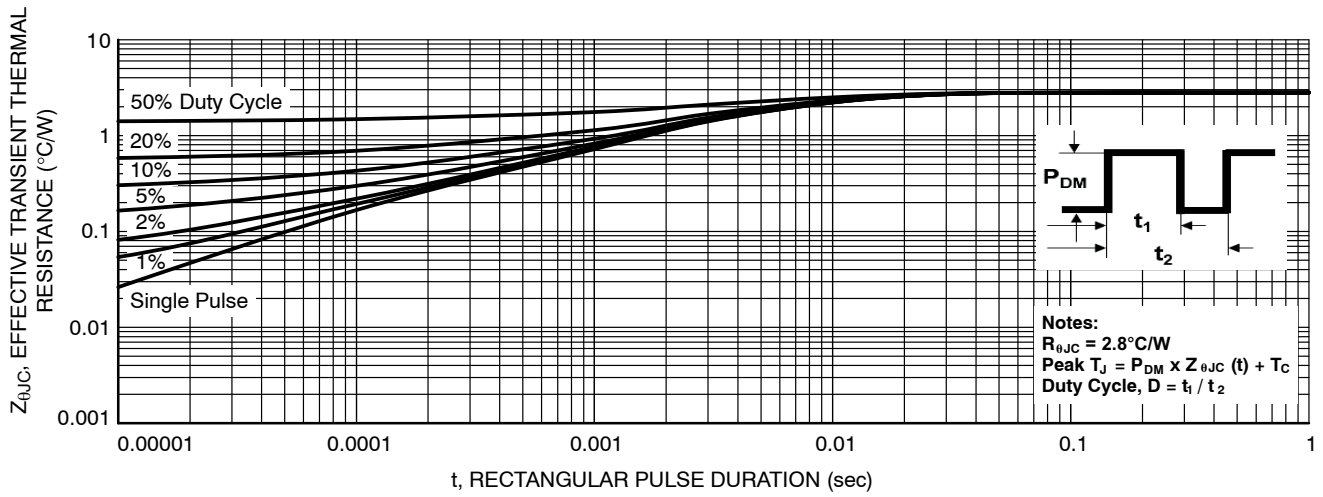
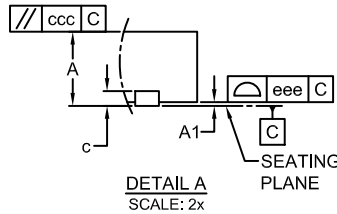
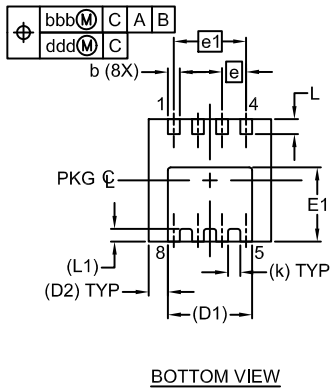
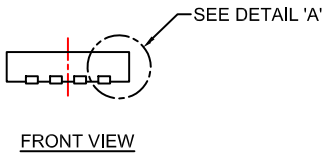
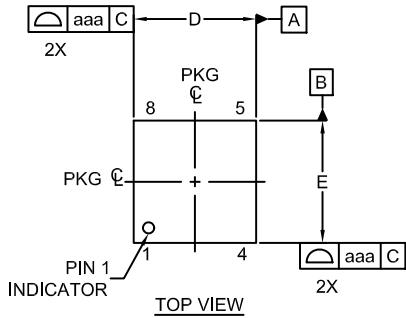

Figure 13. Transient Thermal Impedance

# NTTFS034N15MC

## PACKAGE DIMENSIONS

**WDFN8 3.3X3.3, 0.65P**  
**CASE 483AW**  
**ISSUE A**



### LAND PATTERN RECOMMENDATION\*

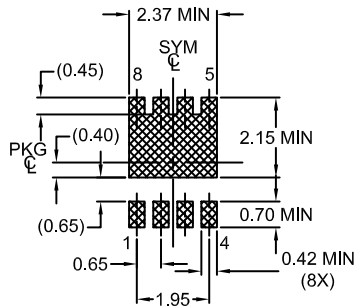

### NOTES:

1. CONTROLLING DIMENSION: MILLIMETERS.
2. COPLANARITY APPLIES TO THE EXPOSED PADS AS WELL AS THE TERMINALS.
3. DIMENSIONS D AND E DO NOT INCLUDE MOLD FLASH, PROTRUSIONS OR GATE BURRS.
4. SEATING PLANE IS DEFINED BY THE TERMINALS. 'A1' IS DEFINED AS THE DISTANCE FROM THE SEATING PLANE TO THE LOWEST POINT ON THE PACKAGE BODY.

DIM	MILLIMETERS		
	MIN	NOM	MAX
A	0.70	0.75	0.80
A1	-	-	0.05
b	0.27	0.32	0.37
c	0.15	0.20	0.25
D	3.20	3.30	3.40
D1	2.27 REF		
D2	0.52 REF		
E	3.20	3.30	3.40
E1	1.85	1.95	2.05
e	0.65 BSC		
e1	1.95 BSC		
k	0.33 REF		
L	0.30	0.40	0.50
L1	0.34 REF		
aaa	0.10		
bbb	0.10		
ccc	0.10		
ddd	0.05		
eee	0.05		

\*FOR ADDITIONAL INFORMATION ON OUR PB-FREE STRATEGY AND SOLDERING DETAILS, PLEASE DOWNLOAD THE ON SEMICONDUCTOR SOLDERING AND MOUNTING TECHNIQUES REFERENCE MANUAL, SOLDERRM/D.

ON Semiconductor and are trademarks of Semiconductor Components Industries, LLC dba ON Semiconductor or its subsidiaries in the United States and/or other countries. ON Semiconductor owns the rights to a number of patents, trademarks, copyrights, trade secrets, and other intellectual property. A listing of ON Semiconductor's product/patent coverage may be accessed at [www.onsemi.com/site/pdf/Patent-Marking.pdf](http://www.onsemi.com/site/pdf/Patent-Marking.pdf). ON Semiconductor reserves the right to make changes without further notice to any products herein. ON Semiconductor makes no warranty, representation or guarantee regarding the suitability of its products for any particular purpose, nor does ON Semiconductor assume any liability arising out of the application or use of any product or circuit, and specifically disclaims any and all liability, including without limitation special, consequential or incidental damages. Buyer is responsible for its products and applications using ON Semiconductor products, including compliance with all laws, regulations and safety requirements or standards, regardless of any support or applications information provided by ON Semiconductor. "Typical" parameters which may be provided in ON Semiconductor data sheets and/or specifications can and do vary in different applications and actual performance may vary over time. All operating parameters, including "Typicals" must be validated for each customer application by customer's technical experts. ON Semiconductor does not convey any license under its patent rights nor the rights of others. ON Semiconductor products are not designed, intended, or authorized for use as a critical component in life support systems or any FDA Class 3 medical devices or medical devices with a same or similar classification in a foreign jurisdiction or any devices intended for implantation in the human body. Should Buyer purchase or use ON Semiconductor products for any such unintended or unauthorized application, Buyer shall indemnify and hold ON Semiconductor and its officers, employees, subsidiaries, affiliates, and distributors harmless against all claims, costs, damages, and expenses, and reasonable attorney fees arising out of, directly or indirectly, any claim of personal injury or death associated with such unintended or unauthorized use, even if such claim alleges that ON Semiconductor was negligent regarding the design or manufacture of the part. ON Semiconductor is an Equal Opportunity/Affirmative Action Employer. This literature is subject to all applicable copyright laws and is not for resale in any manner.

### PUBLICATION ORDERING INFORMATION

LITERATURE FULFILLMENT:  
 Email Requests to: [orderlit@onsemi.com](mailto:orderlit@onsemi.com)

TECHNICAL SUPPORT  
 North American Technical Support:  
 Voice Mail: 1 800-282-9855 Toll Free USA/Canada  
 Phone: 011 421 33 790 2910

Europe, Middle East and Africa Technical Support:  
 Phone: 00421 33 790 2910  
 For additional information, please contact your local Sales Representative