

# LM27341 Step-Down Converter Evaluation Module User's Guide



## Table of Contents

<b>1 Introduction</b> .....	2
<b>2 Evaluation Board Schematic</b> .....	3
<b>3 Powering and Loading Considerations</b> .....	4
3.1 Quick Start Procedure.....	4
3.2 Starting Up.....	4
3.3 Overcurrent Protection.....	4
3.4 Synchronization.....	4
3.5 Adjusting the Output Voltage.....	4
<b>4 Performance Characteristics</b> .....	5
<b>5 Layout and Bill of Materials</b> .....	6
<b>6 PCB Layout</b> .....	7
<b>7 Revision History</b> .....	8

## List of Figures

Figure 4-1. Conversion Efficiency Versus Output Current.....	5
Figure 4-2. Output Voltage During a Typical Start-Up Sequence.....	5
Figure 6-1. Top Layer and Overlay.....	7
Figure 6-2. Internal Layer 1.....	7
Figure 6-3. Internal Layer 2.....	8
Figure 6-4. Bottom Layer.....	8

## List of Tables

Table 5-1. Bill of Materials.....	6
-----------------------------------	---

## Trademarks

All trademarks are the property of their respective owners.

## 1 Introduction

The LM27342 demonstration board is designed to provide the power supply design engineer with a fully functional regulator design, which can be synchronized to an external clock between 1000 kHz and 2350 kHz. The evaluation board provides a 3.3-V output with a 2-A current capability. The wide input voltage ranges from 5 V to 20 V. Without an external synchronization signal, the design operates at 2000 kHz, reducing the solution size and keeping switching noise out of the AM radio band. The printed circuit board (PCB) consists of four layers of copper on FR4 material. There is a ground plane on the internal layer directly beneath the LM27342, and a ground plane on the bottom layer. The LM27342 is thermally tied to the ground planes by thermal vias directly underneath the device. The second internal layer is tied half to  $V_{IN}$  and half to  $V_{OUT}$ . This application report contains the evaluation board schematic, a quick setup procedure, and a bill-of-materials (BOM). For complete circuit design information, see the [LM27341/LM27342/LM27341Q/LM27342Q 2 MHz 1.5A/2A Wide Input Range Step-Down DCDC Regulator with Frequency Synchronization](#) data sheet.

The performance of the evaluation board is as follows:

- Input range: 5 V to 20 V
- Output voltage: 3.3 V
- Output current: 0 A to 2 A
- Frequency of operation: 1000 kHz to 2350 kHz
- Board size: 1.1 inches × 1.3 inches

## 2 Evaluation Board Schematic

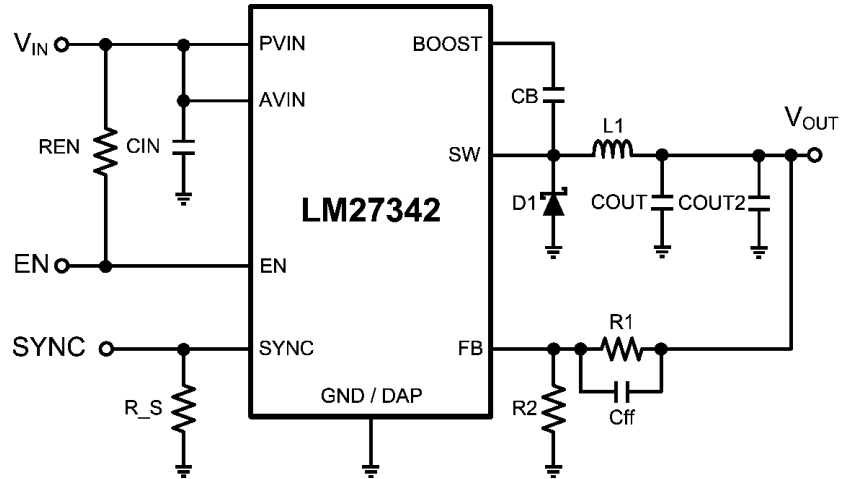

## 3 Powering and Loading Considerations

Read this entire page prior to attempting to power the evaluation board.

### 3.1 Quick Start Procedure

1. Set the bench power supply current limit to 2 A. Set the power supply voltage to 12 V. Turn off the power supply output. Connect the power supply to the LM27342 demo board. Positive connection to  $V_{IN}$  and negative connection to GND.
2. Connect a load, as high as 2 A, to the  $V_{OUT}$  terminal. Positive connection to  $V_{OUT}$  and negative connection to GND.
3. Connect a signal generator to provide a synchronization signal to the SYNC terminal. Positive connection to SYNC and negative connection to GND.
4. The EN pin should be left open for normal operation.
5. Turn on the bench power supply with no load applied to the LM27342.  $V_{OUT}$  should be in regulation with a nominal 3.3-V output.
6. Slowly increase the load while monitoring the output voltage,  $V_{OUT}$  should remain in regulation with a nominal 3.3-V output as the load is increased up to 2 A.
7. Slowly sweep the input voltage from 5 V to 20 V and back to 12 V,  $V_{OUT}$  should remain in regulation with a nominal 3.3-V output.
8. Turn on the signal generator, and synchronize the LM27342 to a 3.3-V square wave at 1 MHz.  $V_{OUT}$  should remain in regulation with a nominal 3.3-V output. Monitor SYNC and SW to observe the synchronization behavior.

### 3.2 Starting Up

The EN pin is tied to  $V_{IN}$  to simplify start up. The pullup resistor allows the power supply design engineer to toggle EN independently, if desired, and observe the start-up behavior of the LM27342.

### 3.3 Overcurrent Protection

The evaluation board is configured with overcurrent protection. The inductor current is limited to 4.0 A (maximum).

### 3.4 Synchronization

A SYNC pin has been provided on the evaluation board. This pin can be used to synchronize the regulator to an external clock or multiple evaluation boards can be synchronized together by connecting their SYNC pins together. Refer to the LM27342 data sheet for complete information

### 3.5 Adjusting the Output Voltage

The output voltage is set using the following equation where R2 is connected between the FB pin and GND, and R1 is connected between  $V_{OUT}$  and FB.

$$R1 = \left( \frac{V_{OUT}}{V_{REF}} - 1 \right) \times R2 \quad (1)$$

Adjusting the output voltage will affect the performance of the LM27342. In addition, output capacitors might not be rated for the new output voltage. Refer to the LM27342 data sheet for more information.

## 4 Performance Characteristics

### Efficiency Plots

Figure 4-1 shows the conversion efficiency versus output current for several input voltage conditions.

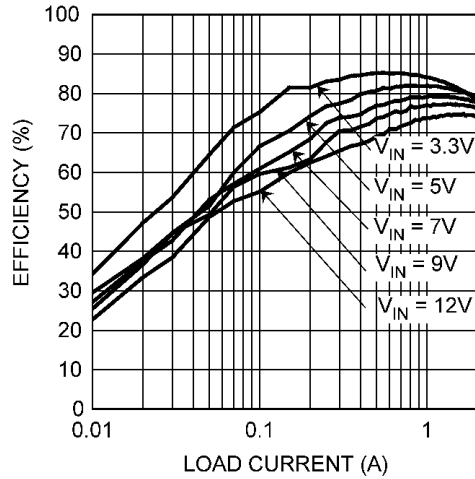
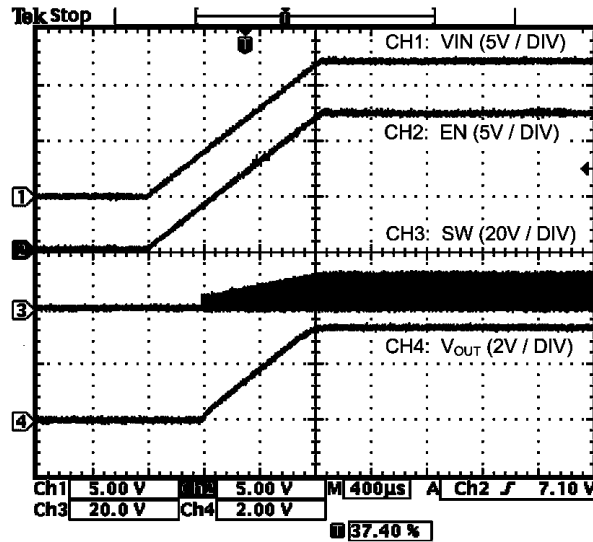

Figure 4-1. Conversion Efficiency Versus Output Current

### Turn-On Waveform

When applying power to the LM27342 evaluation board a soft-start sequence occurs. Figure 4-2 shows the output voltage during a typical start-up sequence.



Output Current = 1A

Figure 4-2. Output Voltage During a Typical Start-Up Sequence

## 5 Layout and Bill of Materials

The bill of materials is shown in [Table 5-1](#), including the manufacturer and part number.

**Table 5-1. Bill of Materials**

Part Name	Part ID	Part Value	Part Number	Manufacturer
Buck Regulator	U1	2A Buck Regulator	LM27342	Texas Instruments
C <sub>IN</sub>	CIN	10 $\mu$ F	TMK325B7106MM-T	Taiyo Yuden
C <sub>BOOST</sub>	CB	0.1 $\mu$ F	C0603C104K8RACTU	Kemet
C <sub>OUT</sub>	COUT	22 $\mu$ F	GRM32ER71A226KE20L	Murata
C <sub>OUT2</sub>	COUT2	22 $\mu$ F	GRM32ER71A226KE20L	Murata
Catch Diode	D1	Schottky Diode, Vf = 0.32 V	CMS06	Toshiba
Inductor	L1	2.7 $\mu$ H	CDRH5D18BHPNP-2R7M	Sumida
Feedback Resistor	R1	430 $\Omega$	MCR03EZPFX4300	Rohm
Feedback Resistor	R2	187 $\Omega$	MCR03EZPFX1870	Rohm
Pullup Resistor	REN	4.7 k $\Omega$	MCR03EZPFX4701	Rohm
Pulldown Resistor	R_S	4.7 k $\Omega$	MCR03EZPFX4701	Rohm
Connectors	VIN, GND, GND, VOUT, EN, SYNC	Turret	160-2043-02-01-00	Cambion
Test Point	SW	Miniature Test Point	5000	Keystone

## 6 PCB Layout

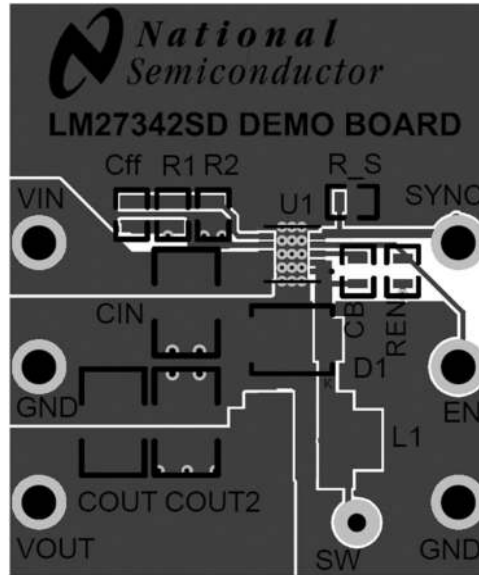

Figure 6-1. Top Layer and Overlay

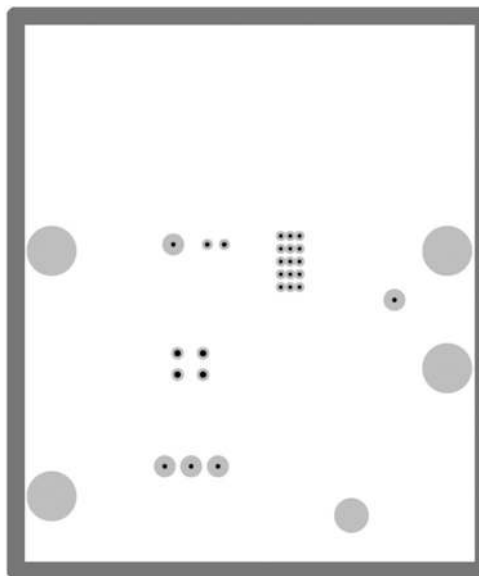
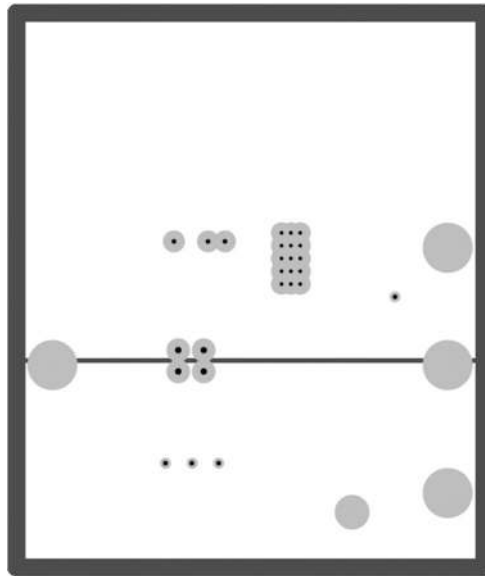
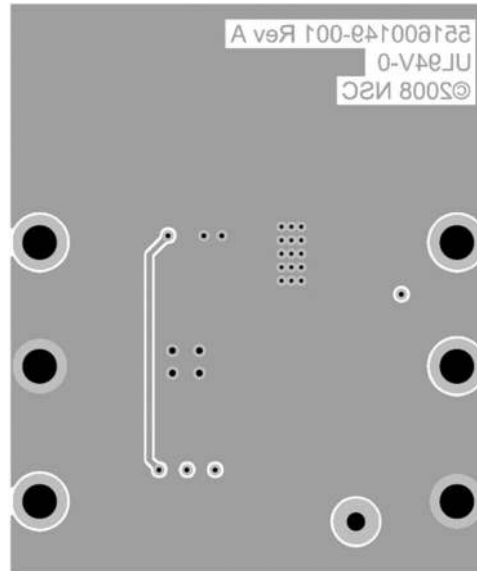

Figure 6-2. Internal Layer 1



**Figure 6-3. Internal Layer 2**



**Figure 6-4. Bottom Layer**

## 7 Revision History

NOTE: Page numbers for previous revisions may differ from page numbers in the current version.

<b>Changes from Revision A (April 2013) to Revision B (December 2021)</b>	<b>Page</b>
• Updated the numbering format for tables, figures, and cross-references throughout the document. ....	2
• Updated the user's guide title .....	2
• Edited user's guide for clarity.....	2



## IMPORTANT NOTICE AND DISCLAIMER

TI PROVIDES TECHNICAL AND RELIABILITY DATA (INCLUDING DATA SHEETS), DESIGN RESOURCES (INCLUDING REFERENCE DESIGNS), APPLICATION OR OTHER DESIGN ADVICE, WEB TOOLS, SAFETY INFORMATION, AND OTHER RESOURCES "AS IS" AND WITH ALL FAULTS, AND DISCLAIMS ALL WARRANTIES, EXPRESS AND IMPLIED, INCLUDING WITHOUT LIMITATION ANY IMPLIED WARRANTIES OF MERCHANTABILITY, FITNESS FOR A PARTICULAR PURPOSE OR NON-INFRINGEMENT OF THIRD PARTY INTELLECTUAL PROPERTY RIGHTS.

These resources are intended for skilled developers designing with TI products. You are solely responsible for (1) selecting the appropriate TI products for your application, (2) designing, validating and testing your application, and (3) ensuring your application meets applicable standards, and any other safety, security, regulatory or other requirements.

These resources are subject to change without notice. TI grants you permission to use these resources only for development of an application that uses the TI products described in the resource. Other reproduction and display of these resources is prohibited. No license is granted to any other TI intellectual property right or to any third party intellectual property right. TI disclaims responsibility for, and you will fully indemnify TI and its representatives against, any claims, damages, costs, losses, and liabilities arising out of your use of these resources.

TI's products are provided subject to [TI's Terms of Sale](#) or other applicable terms available either on [ti.com](http://ti.com) or provided in conjunction with such TI products. TI's provision of these resources does not expand or otherwise alter TI's applicable warranties or warranty disclaimers for TI products.

TI objects to and rejects any additional or different terms you may have proposed.

Mailing Address: Texas Instruments, Post Office Box 655303, Dallas, Texas 75265  
Copyright © 2022, Texas Instruments Incorporated