

# TAS5766MDCAEVM

This user's guide describes the operation of the TAS5766MDCAEVM. The TAS5766MDCAEVM is connected to the PurePath™ Console Motherboard (PPCMB). For questions and support go to the E2E forums (e2e.ti.com). The main contents of this document are:

- Hardware descriptions and implementation
- Start up procedure using PurePath Console (PPC) software with TAS5766M plug-in

Related documents:

- TAS5766M Data Sheet ([SLASE25](#))
- *PurePath Console Motherboard User's Guide* ([SLOU366](#))
- PurePath Graphic Development Suite ([PurePath Console](#))

## Contents

1	Hardware Overview.....	2
1.1	TAS5766MDCAEVM Features.....	2
1.2	TAS5766MDCAEVM Functions.....	3
1.3	TAS5766MDCAEVM Detailed Operations.....	3
2	TAS5766MDCAEVM Setup .....	4
2.1	Hardware Setup.....	4
2.2	Software Installation .....	5
3	Using the PurePath Console with the TAS5766MDCAEVM Board .....	6
3.1	TAS5766M Main Tab.....	6
3.2	TAS5766M Block Diagram Tab.....	7
3.3	Pop-Up Windows .....	8
3.4	Direct I <sup>2</sup> C Access Tab .....	10
3.5	Device Registers Tab.....	10
4	Board Layouts, Bill of Materials, and Schematics.....	11
4.1	TAS5766MDCAEVM Board Layouts .....	11
4.2	Bill of Materials .....	12
4.3	TAS5766MDCAEVM Schematic .....	13

## List of Figures

1	PPCMB and TAS5766MDCAEVM.....	2
2	Device Manager.....	3
3	PPCMB and TAS5766MDCAEVM Connection .....	4
4	Target Selection List.....	5
5	Add Target List .....	5
6	PPCMB and TAS5766MDCAEVM.....	6
7	TAS5766M Block Diagram .....	7
8	Smart Amplifier GUI Pop-Up .....	8
9	Biquad Block Pop-up .....	9
10	Direct I <sup>2</sup> C Access .....	10
11	Device Registers Tab.....	10
12	TAS5766MDCAEVM Top Composite Assembly .....	11
13	TAS5766MDCAEVM Bottom Composite Assembly .....	11

14	TAS5766MDCAEVM Schematic (Page 1 of 2).....	13
15	TAS5766MDCAEVM Schematic (Page 2 of 2).....	14

### List of Tables

1	TAS5766MDCAEVM Bill of Materials.....	12
---	---------------------------------------	----

## 1 Hardware Overview

The TAS5766MDCAEVM showcases the latest TI digital input class D closed loop amplifier. The TAS5766M is an I2S or TDM input class D amplifier with PurePath Smart Amp. The EVM is used in conjunction with the PurePath Console Motherboard (PPCMB). The PVDD supply is provided via the TAS5766MDCAEVM and is regulated to 5 VDC and 3.3 VDC on the PPCMB. The PPCMB provides the I2S, I2C and 3.3 VDC to the TAS5766MDCAEVM.

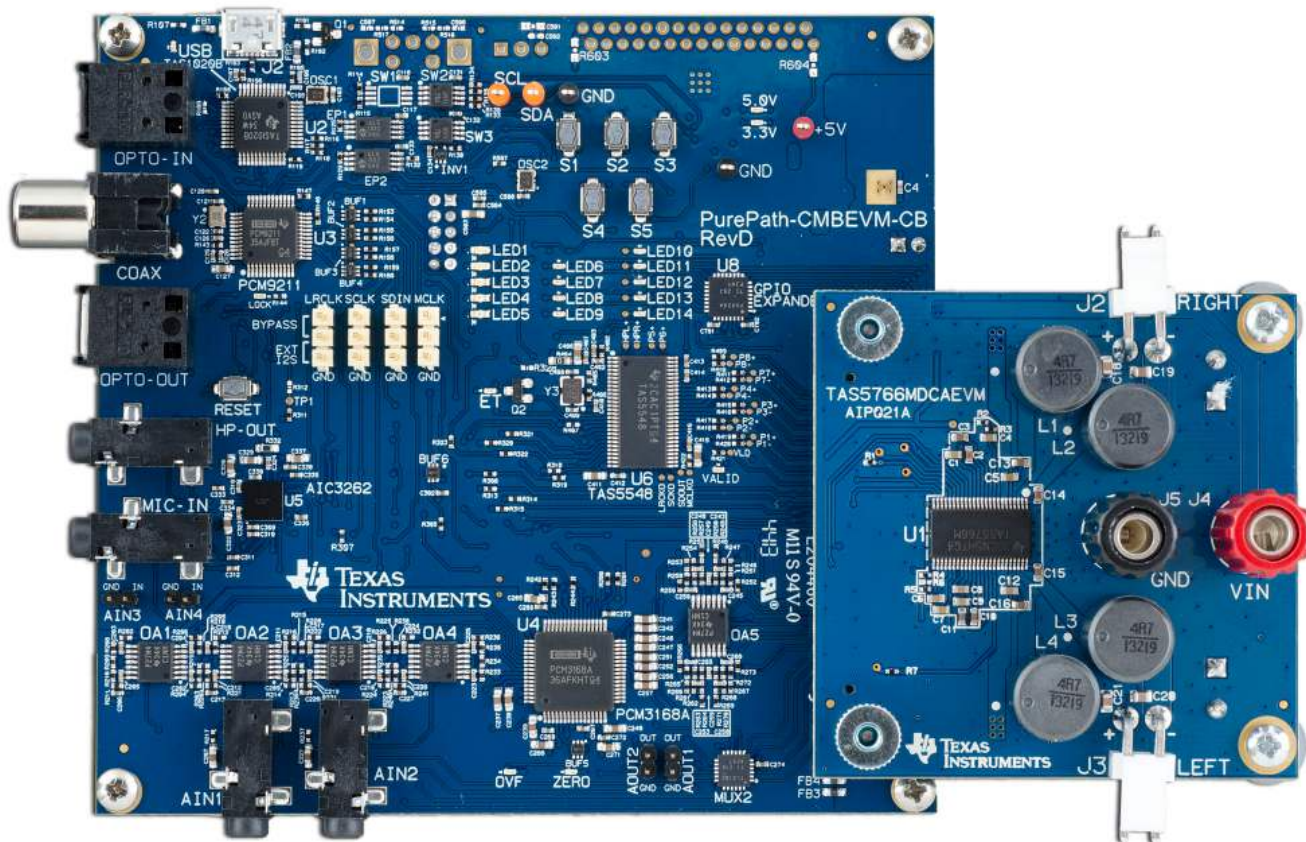

Figure 1. PPCMB and TAS5766MDCAEVM

### 1.1 TAS5766MDCAEVM Features

- GUI control via USB port
- Stereo channels with I2S or TDM

PurePath is a trademark of Texas Instruments.

Microsoft, Windows Media, Windows are registered trademarks of Microsoft Corporation.

## 1.2 TAS5766MDCAEVM Functions

The TAS5766MDCAEVM is controlled by the PPCMB. The PPCMB sends I2C commands from PPC to the TAS5766M. Upon PPC execution and connection, the TAS5766M is put in software mode.

The digital audio data input to the TAS5766MDCAEVM is sent from PPCMB and is selectable from USB audio, optical SPDIF, coaxial SPDIF, and analog ADC sources. When a digital audio data input is selected, the PPC automatically sends appropriate scripts to the device in use.

## 1.3 TAS5766MDCAEVM Detailed Operations

Upon power-on, the PPCMB uses USB audio input (default). The I2S signals, LRCLK, SCLK, SDIN, and MCLK, come from the TAS1020B. The Microsoft® Windows Media® player can stream audio. The TAS1020B enumerates as the following device on the Microsoft Windows® operating system: USB audio (USB-AudioEVM), human interface devices and USB composite device, see [Figure 2](#).

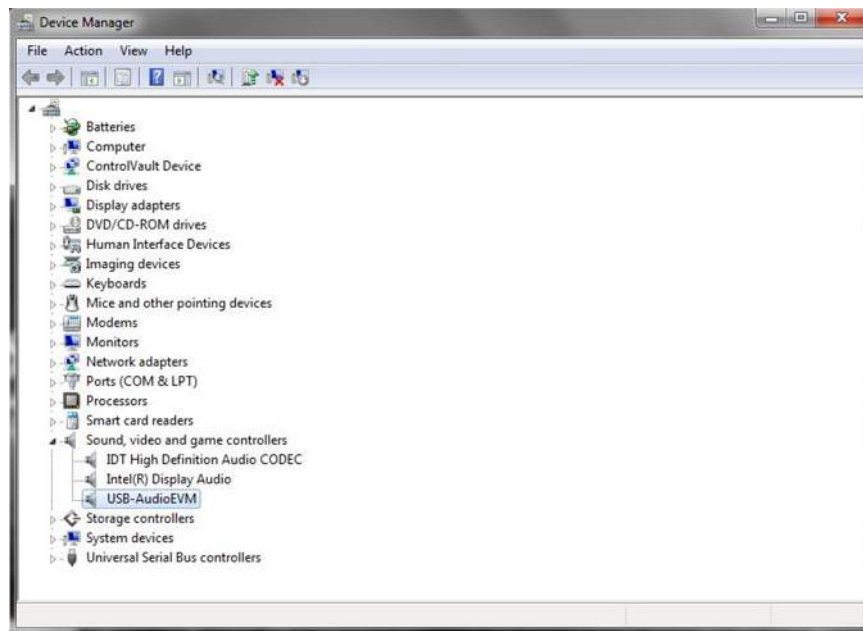

**Figure 2. Device Manager**

## 2 TAS5766MDCAEVM Setup

This section describes the TAS5766MDCAEVM setup and software installation. Since PPCMB connects to one of the device under test (DUT) EVMs, it is necessary to show the connection in this section. The TAS5766MDCAEVM is used for this purpose.

### 2.1 Hardware Setup

Figure 3 shows the EVM with the parts labeled.

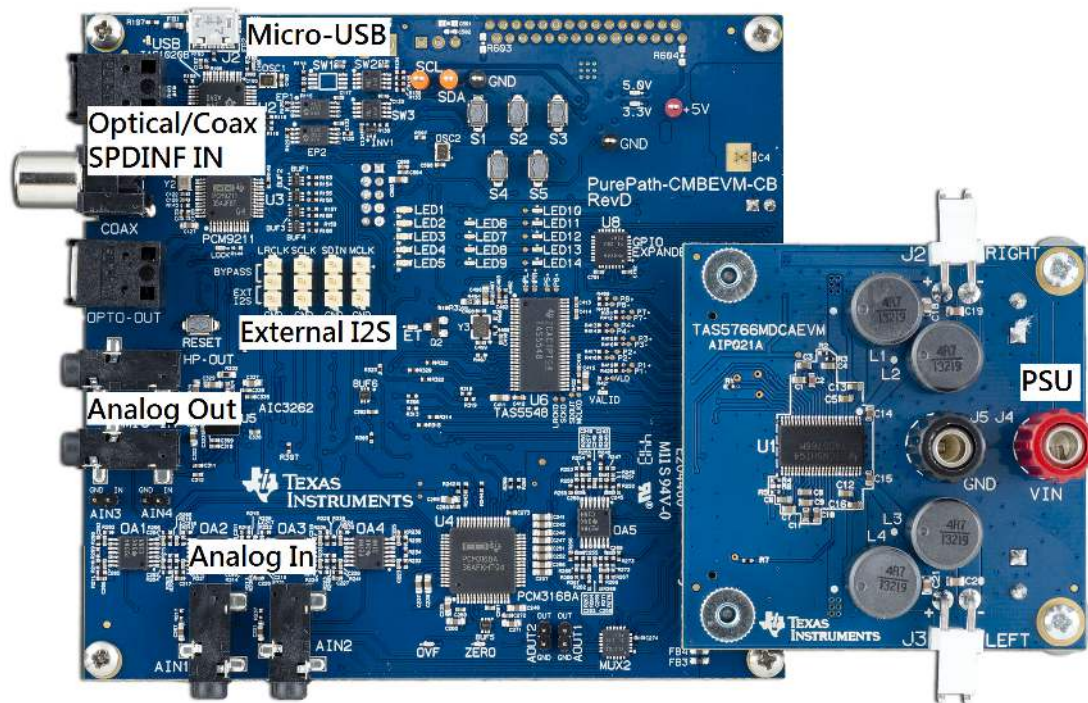

**Figure 3. PPCMB and TAS5766MDCAEVM Connection**

Hardware requirements:

- Desktop or laptop PC running Windows 7
- Power supply 4.5–26.4 VDC
- Speakers and cable
- A USB micro type B cable
- Audio source: This can be a DVD player with the appropriate SPDIF cable or Windows Media Player from Windows XP or Windows 7

Setup procedure:

- Plug in the USB cable from the PC to the PPCMB; the USB Lock LED (blue) is illuminated
- Connect the PPCMB to the TAS5766MDCAEVM
- Connect the PSU to TAS5766MDCAEVM and turn on the power. 5-V and 3.3-V LEDs are illuminated.
- If an optical SPDIF source is used, the blue SPDIF clock-locked LED is illuminated
- Disregard the orange LED indicating the energy threshold (ET) level is exceeded. Clearing the ET value turns the orange LED off.



## 2.2 Software Installation

Download the PurePath Console (PPC) GUI from the [PurePath Console](#) folder. The TI website has the latest release of the GUI.

Execute the GUI installation program, Setup\_PurePathConsole\_Main\_vxx\_revxx.exe. Once the program is installed, the program group and shortcut icon is created in Start → Program → Texas Instruments Inc → PurePath Console → Choose Target. The *Target Selection* window is displayed; select *TAS5766M – Smart Amplifier*, as shown in [Figure 4](#).

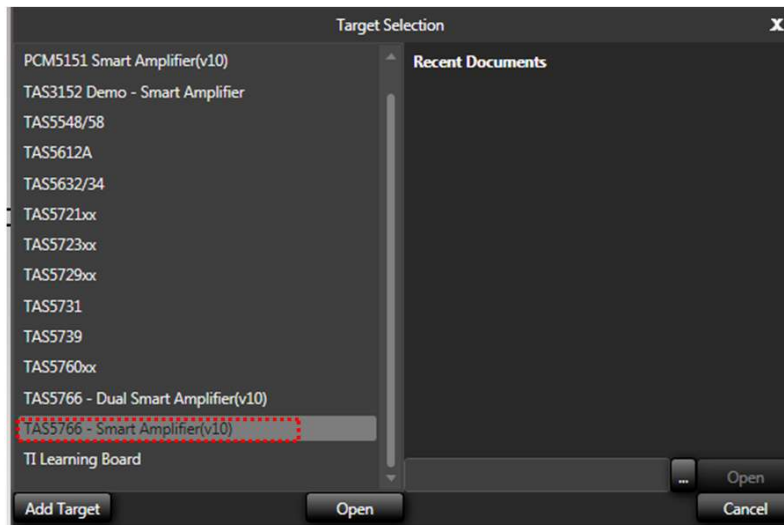

Figure 4. Target Selection List

If the device is not listed in the *Target Selection* list, click on *Add Target* and Windows Explorer displays. Navigate to the folder containing the target .ppc files (plugins) and choose the device plugin. Make sure that the plugin has the same version and revision number as the PPC you are using.

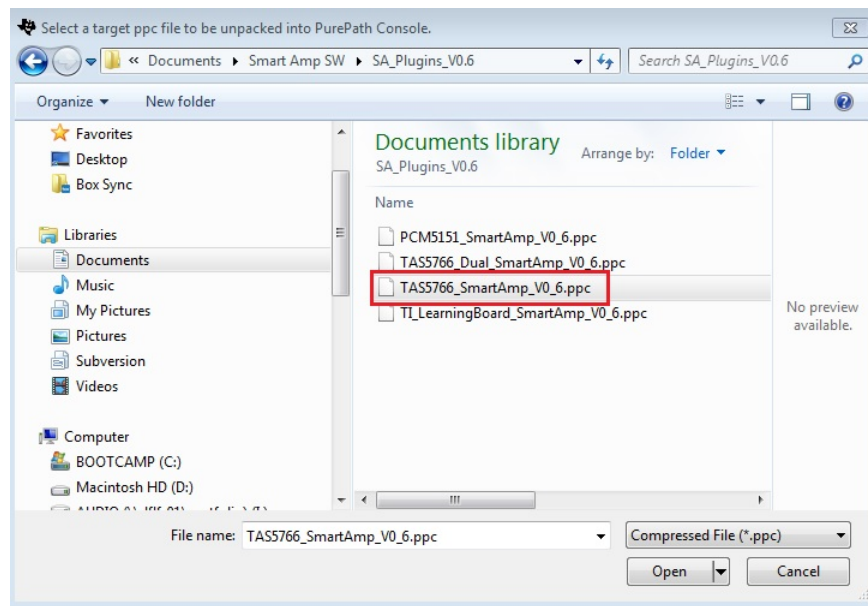
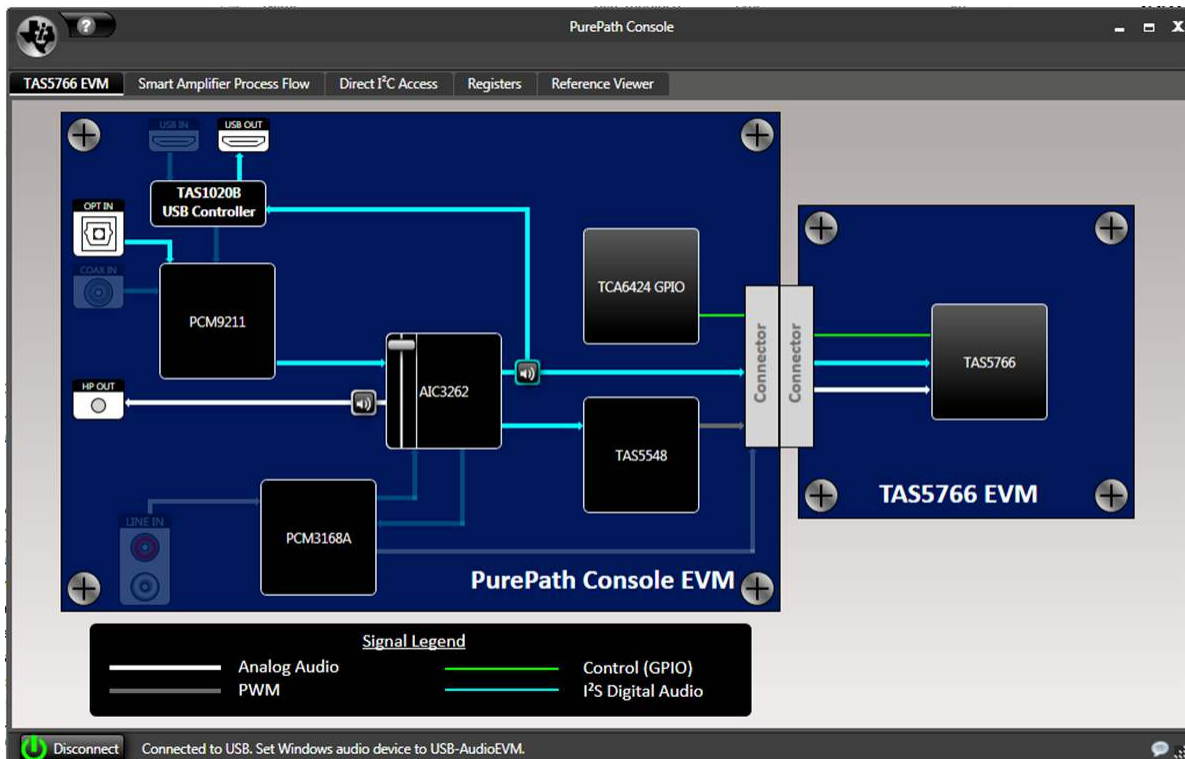

Figure 5. Add Target List



**Figure 6. PPCMB and TAS5766MDCAEVM**

The green LED on the bottom left corner of the PPC window indicates the initialization of TAS5766M is valid.

The PPCMB is initialized with the USB audio (USB-AudioEVM) selected. Streaming audio from the USB host is routed to the TAS5766M.

If an optical input is used, click on the OPT IN symbol on the PPC software, the I2S is then routed with this signal. Likewise, with a COAX/SPDIF input using the COAX IN symbol. If an analog input is used, click on the LINE IN symbol on the PPC software, the ADC (PCM3168A) is the source of I2S data.

- On the PPCMB, the USB blue LED is on, the green LEDs for 3.3 V and 5 V are on
- On the PPC, the green LED on the bottom left corner is on

### 3 Using the PurePath Console with the TAS5766MDCAEVM Board

The TAS5766MDCAEVM is initialized upon PurePath Console startup. Audio is streaming to the speakers if Windows Media (or similar program) is playing and mini-USB EVM is selected in the sound playback properties. The following indicators show both the PPC GUI and TAS5766MDCAEVM are operating correctly:

#### 3.1 TAS5766M Main Tab

Figure 6 shows the DUT tab as displayed when the PPC GUI starts up. Here, you can click on the TAS5766M icon and it directs you to the device block diagram.

### 3.2 TAS5766M Block Diagram Tab

This tab, illustrated in Figure 7, shows the device major blocks. Some of the blocks are selectable. When a block is selected (double click), it shows pop-up settings for the particular setting.

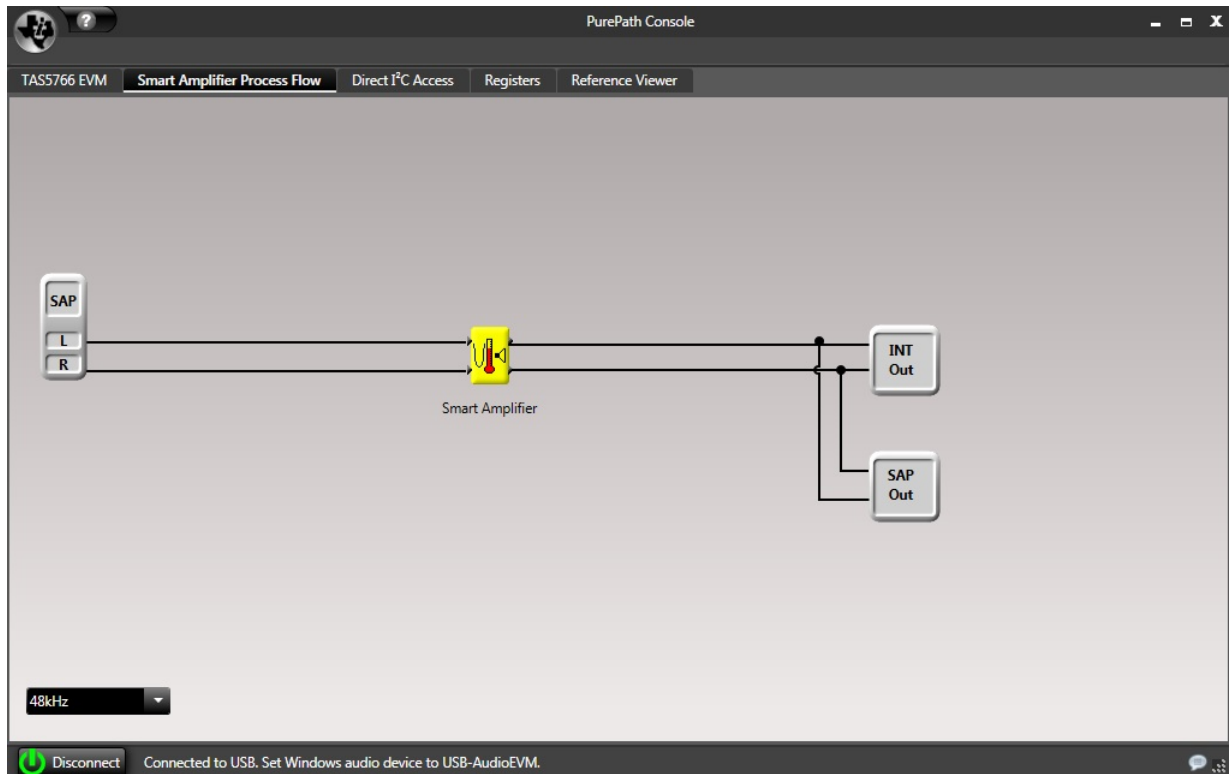

Figure 7. TAS5766M Block Diagram

### 3.3 Pop-Up Windows

For TAS5766M, there are several settings that are done via I2C. The GUI facilitates these settings seamlessly using the pop-up windows seen in Figure 8 and Figure 9.

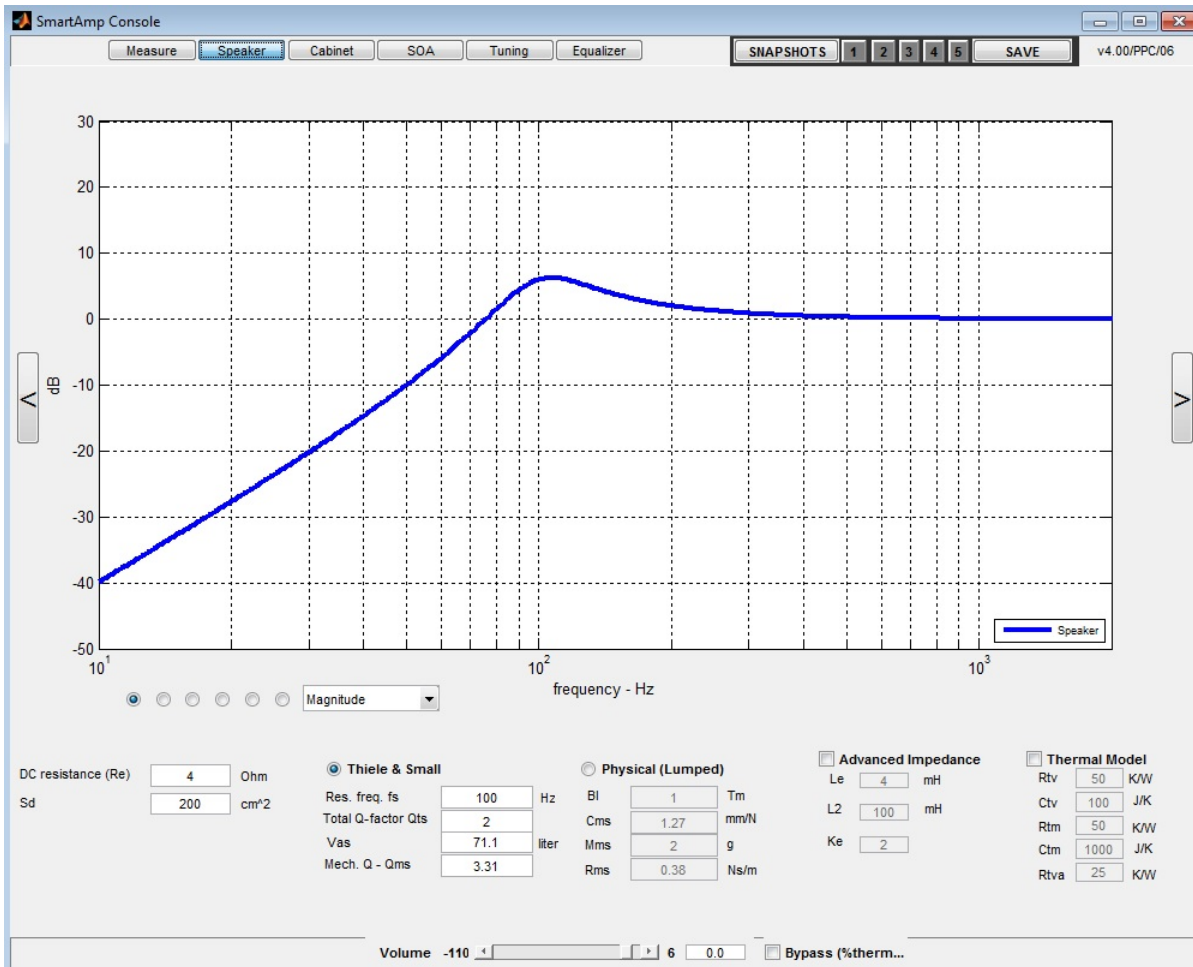

Figure 8. Smart Amplifier GUI Pop-Up



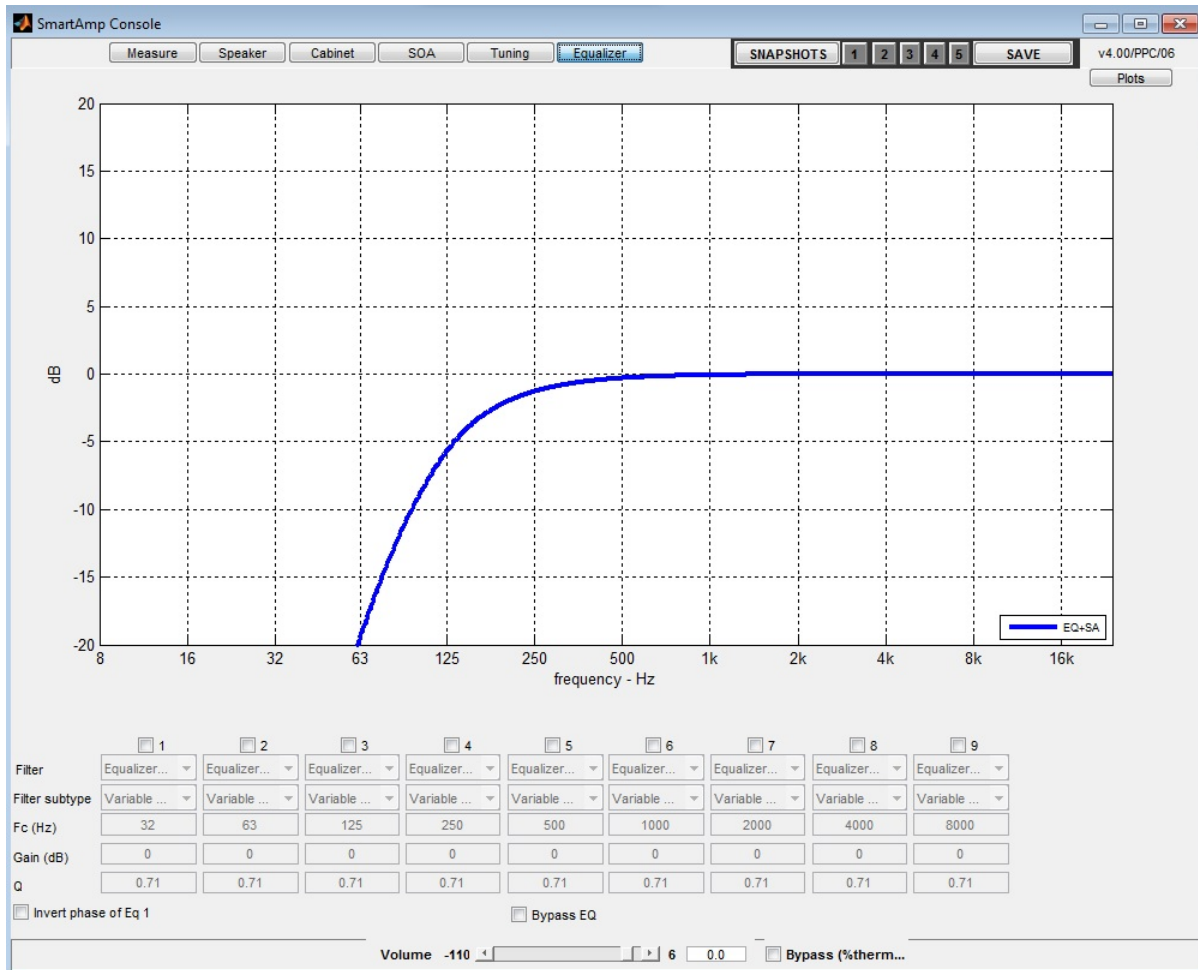

Figure 9. Biquad Block Pop-up

### 3.4 Direct I<sup>2</sup>C Access Tab

I<sup>2</sup>C registers read and write can be performed on this tab (see Figure 10). Type in the device I<sup>2</sup>C address and click Set. On the Direct I<sup>2</sup>C Read/Write box, enter a valid I<sup>2</sup>C register for read and type in both valid register and data for write.

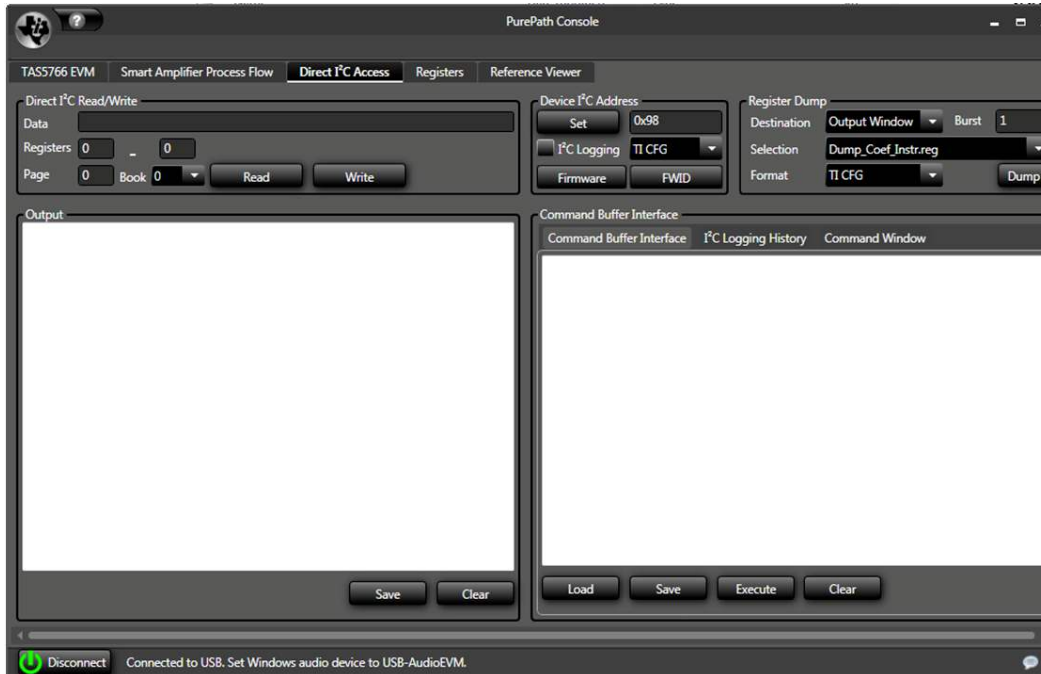
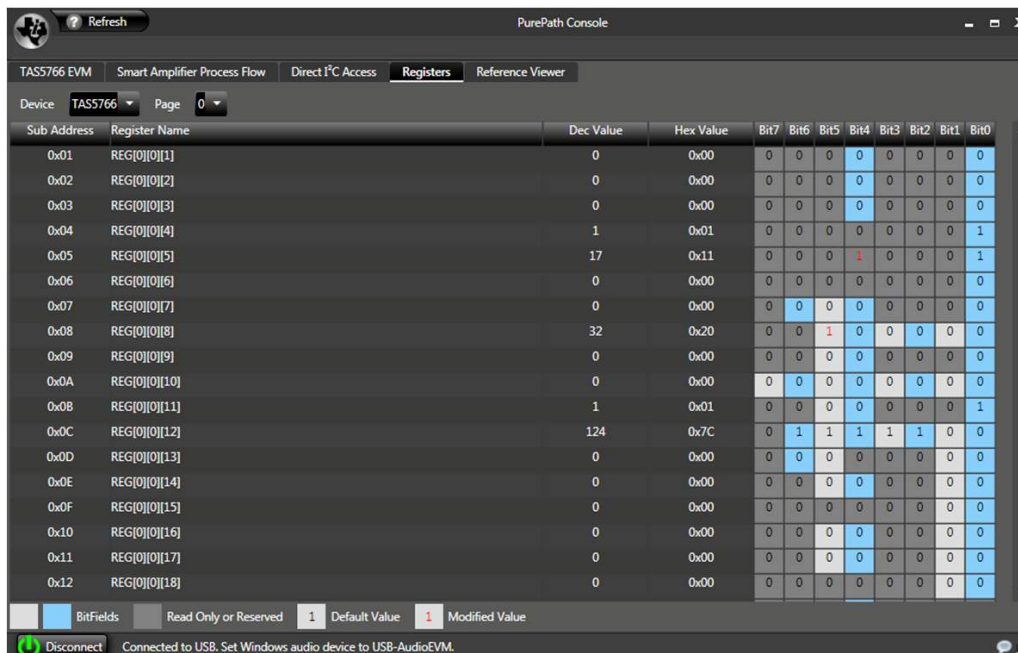

Figure 10. Direct I<sup>2</sup>C Access

### 3.5 Device Registers Tab

Figure 11 shows the current I<sup>2</sup>C registers values (hexadecimal and decimal) in the TAS5766M.



Sub Address	Register Name	Dec Value	Hex Value	Bit7	Bit6	Bit5	Bit4	Bit3	Bit2	Bit1	Bit0
0x01	REG[0][0][1]	0	0x00	0	0	0	0	0	0	0	0
0x02	REG[0][0][2]	0	0x00	0	0	0	0	0	0	0	0
0x03	REG[0][0][3]	0	0x00	0	0	0	0	0	0	0	0
0x04	REG[0][0][4]	1	0x01	0	0	0	0	0	0	0	1
0x05	REG[0][0][5]	17	0x11	0	0	0	1	0	0	0	1
0x06	REG[0][0][6]	0	0x00	0	0	0	0	0	0	0	0
0x07	REG[0][0][7]	0	0x00	0	0	0	0	0	0	0	0
0x08	REG[0][0][8]	32	0x20	0	0	1	0	0	0	0	0
0x09	REG[0][0][9]	0	0x00	0	0	0	0	0	0	0	0
0x0A	REG[0][0][10]	0	0x00	0	0	0	0	0	0	0	0
0x0B	REG[0][0][11]	1	0x01	0	0	0	0	0	0	0	1
0x0C	REG[0][0][12]	124	0x7C	0	1	1	1	1	1	0	0
0x0D	REG[0][0][13]	0	0x00	0	0	0	0	0	0	0	0
0x0E	REG[0][0][14]	0	0x00	0	0	0	0	0	0	0	0
0x0F	REG[0][0][15]	0	0x00	0	0	0	0	0	0	0	0
0x10	REG[0][0][16]	0	0x00	0	0	0	0	0	0	0	0
0x11	REG[0][0][17]	0	0x00	0	0	0	0	0	0	0	0
0x12	REG[0][0][18]	0	0x00	0	0	0	0	0	0	0	0

Figure 11. Device Registers Tab

## 4 Board Layouts, Bill of Materials, and Schematics

### 4.1 TAS5766MDCAEVM Board Layouts

Figure 12 and Figure 13 illustrate the board layouts for the EVM.

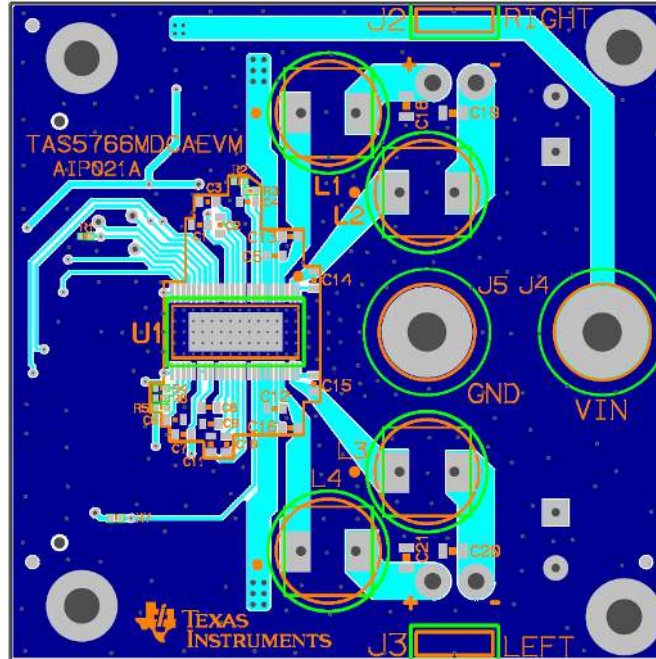

Figure 12. TAS5766MDCAEVM Top Composite Assembly

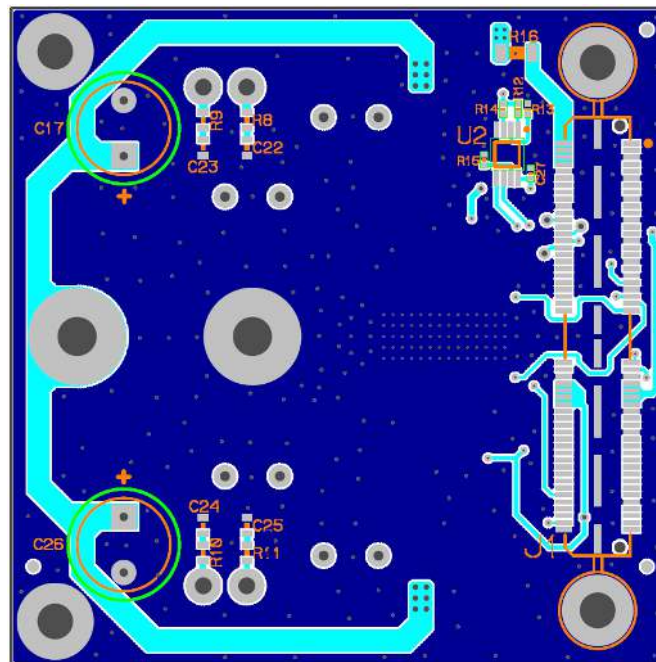

Figure 13. TAS5766MDCAEVM Bottom Composite Assembly

## 4.2 Bill of Materials

Table 1 displays the BOM for this EVM.

**Table 1. TAS5766MDCAEVM Bill of Materials**

Item	MFG Part Num	MFG	QTY	Ref Designators	Description
1	TAS5766DCA	TEXAS INSTRUMENTS	1	U1	NO DATA YET HTSSOP48-DCA ROHS
2	24LC256-I/MS	MICROCHIP	1	U2	SERIAL EEPROM I2C 256K 400kHz MSOP8-MS ROHS
3	UMK107AB7105KA-T	TAIYO YUDEN	6	C1, C4, C6, C7, C8, C9	CAP SMD0603 CERM 1.0UFD 50V 10% X7R ROHS
4	GCM188R71H224KA64D	MURATA	4	C2, C3, C10, C11	CAP SMD0603 CERM 0.22UFD 50V 10% X7R ROHS
5	UMK107AB7105KA-T	TAIYO YUDEN	2	C5, C12	CAP SMD0603 CERM 1.0UFD 50V 10% X7R ROHS
6	GCM188R71H224KA64D	MURATA	4	C13, C14, C15, C16	CAP SMD0603 CERM 0.22UFD 50V 10% X7R ROHS
7	EEU-FC1H221	PANASONIC	2	C17, C26	CAP THRU ALUM-ELECT FC SERIES 220ufd 50V 20% 10x5x20mm ROHS
8	C2012X7R1H684K	TDK	4	C18, C19, C20, C21	CAP SMD0805 CERM 0.68ufd 50V 10% X7R ROHS
9	GRM188R71H103KA01D	MURATA	4	C22, C23, C24, C25	CAP SMD0603 CERM 0.01UFD 50V 10% X7R ROHS
10	C1005X5R1A105K	TDK CORP	1	C30	CAP SMD0402 CERM 1.0UFD 10V 10% X5R ROHS
11	CRCW040210K0FKED	VISHAY	7	R1, R4, R7, R20, R21, R22, R23	RESISTOR SMD0402 10.0K OHMS 1% 1/16W ROHS
12	ERJ-2RKF1003X	PANASONIC	2	R2, R5	RESISTOR SMD0402 THICK FILM 100K OHMS 1/16W 1% ROHS
12a	ERJ-2RKF1003X	PANASONIC	0	R6 (DNP)	RESISTOR SMD0402 THICK FILM 100K OHMS 1/16W 1% ROHS
13	CRCW040220K0FKED	VISHAY	1	R3	RESISTOR SMT 0402 1% 1/16W 20.0K ROHS
14	ERJ-3GEYJ3R3V	PANASONIC	4	R8, R9, R10, R11	RESISTOR SMD0603 3.3 OHMS 5% 1/10W ROHS
15	ERJ-8GEY0R00V	PANASONIC	1	R12	RESISTOR SMD1206 0.0 OHM 5% 1/4W ROHS
16	A7503AY-4R7M	TOKO	4	L1, L2, L3, L4	INDUCTOR SERIES 11RHBP/A7503AY 4.7uH/5.1A ROHS
17	QTS-050-01-F-D-A	SAMTEC	1	J1	CONNECTOR SMT/THU 100 POS+GND MATE HEIGHT 5mm ROHS
18	B2PS-VH(LF)(SN)	JST	2	LEFT, RIGHT	JACK JST-VH RA 2-PIN 3.96mmLS ROHS
19	7006	KEYSTONE ELECTRONICS	1	VIN	BINDING POST, RED, 15A ECONO ROHS
20	7007	KEYSTONE ELECTRONICS	1	GND	BINDING POST, BLACK, 15A ECONO ROHS
21	95947A060	MCMaster-CARR	2	STANDOFFS	STANDOFF M3x30mm 6mm DIA HEX ALUM F-F ROHS
22	92000A118	MCMaster-CARR	2	STANDOFF SCREWS	SCREW M3x8 PHILIPS PANHEAD STAINLESS STEEL ROHS
23	92148A150	MCMaster-CARR	2	STANDOFF WASHERS	WASHER SPLIT-LOCK M3 6.2mm OD 0.7mm THICK STAINLESS STEEL ROHS

### 4.3 TAS5766MDCAEVM Schematic

The schematics for TAS5766MDCAEVM are illustrated in Figure 14 and Figure 15.

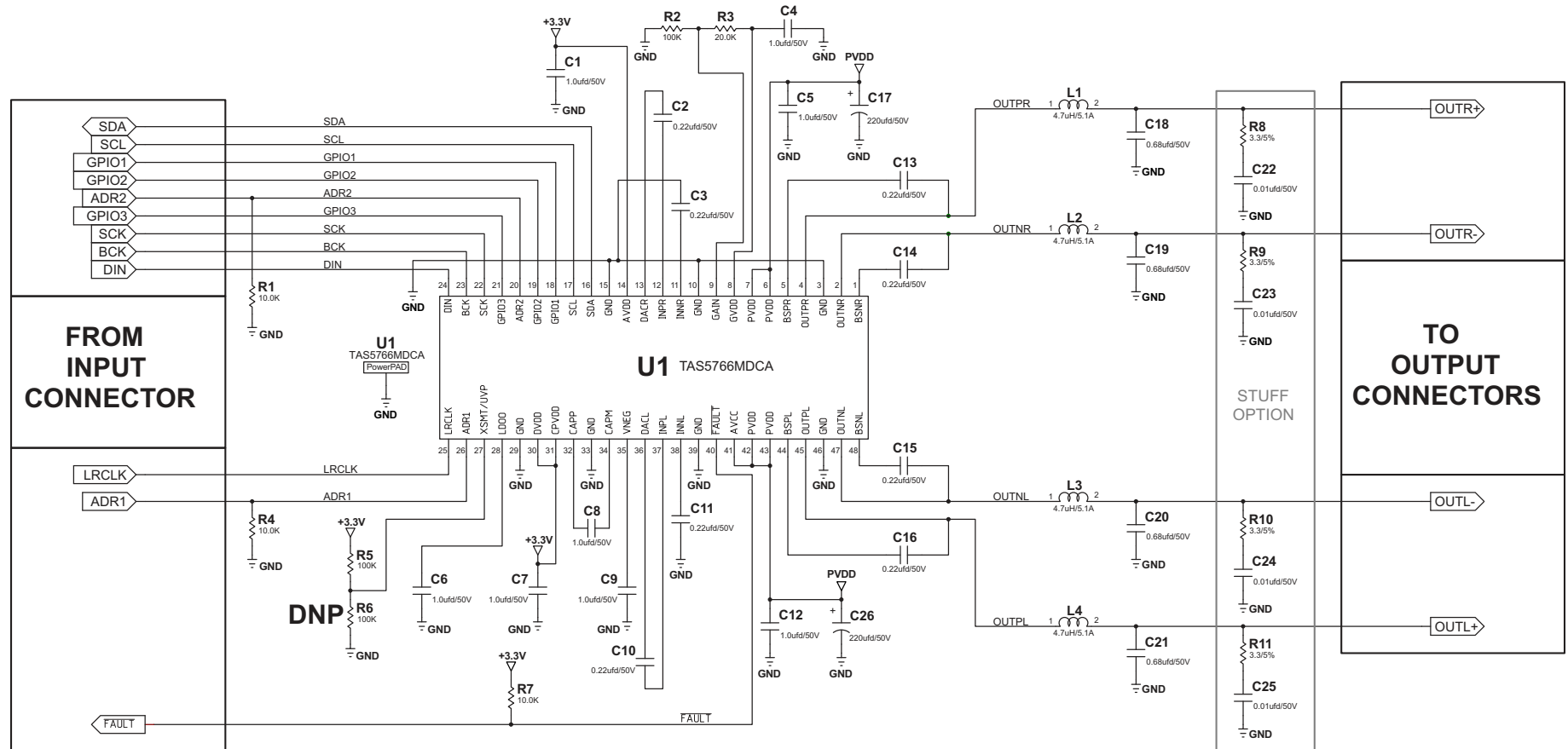

Figure 14. TAS5766MDCAEVM Schematic (Page 1 of 2)



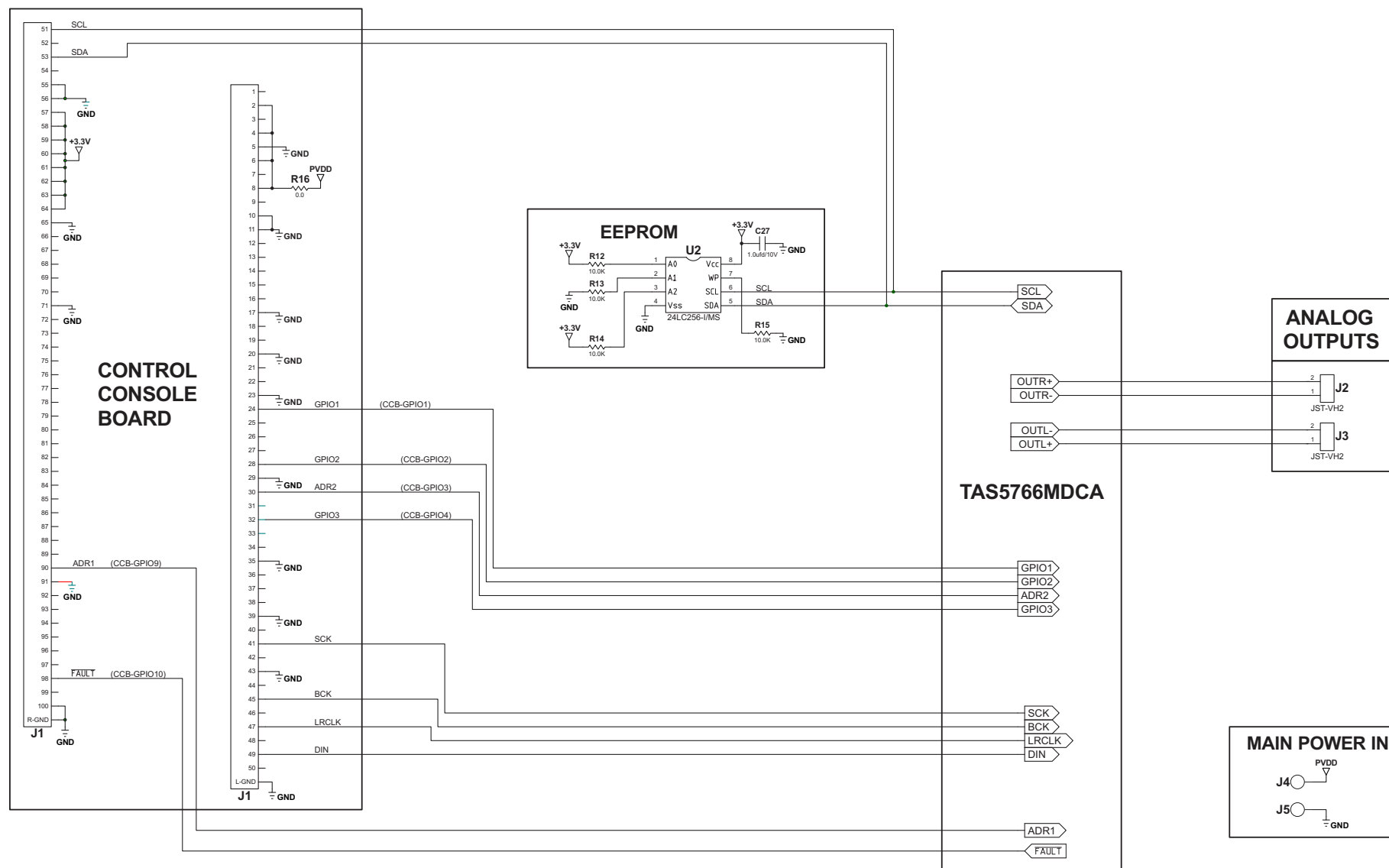

Figure 15. TAS5766MDCAEVM Schematic (Page 2 of 2)

## STANDARD TERMS AND CONDITIONS FOR EVALUATION MODULES

1. *Delivery:* TI delivers TI evaluation boards, kits, or modules, including any accompanying demonstration software, components, or documentation (collectively, an "EVM" or "EVMs") to the User ("User") in accordance with the terms and conditions set forth herein. Acceptance of the EVM is expressly subject to the following terms and conditions.
  - 1.1 EVMs are intended solely for product or software developers for use in a research and development setting to facilitate feasibility evaluation, experimentation, or scientific analysis of TI semiconductors products. EVMs have no direct function and are not finished products. EVMs shall not be directly or indirectly assembled as a part or subassembly in any finished product. For clarification, any software or software tools provided with the EVM ("Software") shall not be subject to the terms and conditions set forth herein but rather shall be subject to the applicable terms and conditions that accompany such Software
  - 1.2 EVMs are not intended for consumer or household use. EVMs may not be sold, sublicensed, leased, rented, loaned, assigned, or otherwise distributed for commercial purposes by Users, in whole or in part, or used in any finished product or production system.
2. *Limited Warranty and Related Remedies/Disclaimers:*
  - 2.1 These terms and conditions do not apply to Software. The warranty, if any, for Software is covered in the applicable Software License Agreement.
  - 2.2 TI warrants that the TI EVM will conform to TI's published specifications for ninety (90) days after the date TI delivers such EVM to User. Notwithstanding the foregoing, TI shall not be liable for any defects that are caused by neglect, misuse or mistreatment by an entity other than TI, including improper installation or testing, or for any EVMs that have been altered or modified in any way by an entity other than TI. Moreover, TI shall not be liable for any defects that result from User's design, specifications or instructions for such EVMs. Testing and other quality control techniques are used to the extent TI deems necessary or as mandated by government requirements. TI does not test all parameters of each EVM.
  - 2.3 If any EVM fails to conform to the warranty set forth above, TI's sole liability shall be at its option to repair or replace such EVM, or credit User's account for such EVM. TI's liability under this warranty shall be limited to EVMs that are returned during the warranty period to the address designated by TI and that are determined by TI not to conform to such warranty. If TI elects to repair or replace such EVM, TI shall have a reasonable time to repair such EVM or provide replacements. Repaired EVMs shall be warranted for the remainder of the original warranty period. Replaced EVMs shall be warranted for a new full ninety (90) day warranty period.
3. *Regulatory Notices:*
  - 3.1 *United States*
    - 3.1.1 *Notice applicable to EVMs not FCC-Approved:*

This kit is designed to allow product developers to evaluate electronic components, circuitry, or software associated with the kit to determine whether to incorporate such items in a finished product and software developers to write software applications for use with the end product. This kit is not a finished product and when assembled may not be resold or otherwise marketed unless all required FCC equipment authorizations are first obtained. Operation is subject to the condition that this product not cause harmful interference to licensed radio stations and that this product accept harmful interference. Unless the assembled kit is designed to operate under part 15, part 18 or part 95 of this chapter, the operator of the kit must operate under the authority of an FCC license holder or must secure an experimental authorization under part 5 of this chapter.
    - 3.1.2 *For EVMs annotated as FCC – FEDERAL COMMUNICATIONS COMMISSION Part 15 Compliant:*

### CAUTION

This device complies with part 15 of the FCC Rules. Operation is subject to the following two conditions: (1) This device may not cause harmful interference, and (2) this device must accept any interference received, including interference that may cause undesired operation.

Changes or modifications not expressly approved by the party responsible for compliance could void the user's authority to operate the equipment.

### FCC Interference Statement for Class A EVM devices

*NOTE: This equipment has been tested and found to comply with the limits for a Class A digital device, pursuant to part 15 of the FCC Rules. These limits are designed to provide reasonable protection against harmful interference when the equipment is operated in a commercial environment. This equipment generates, uses, and can radiate radio frequency energy and, if not installed and used in accordance with the instruction manual, may cause harmful interference to radio communications. Operation of this equipment in a residential area is likely to cause harmful interference in which case the user will be required to correct the interference at his own expense.*

## FCC Interference Statement for Class B EVM devices

*NOTE: This equipment has been tested and found to comply with the limits for a Class B digital device, pursuant to part 15 of the FCC Rules. These limits are designed to provide reasonable protection against harmful interference in a residential installation. This equipment generates, uses and can radiate radio frequency energy and, if not installed and used in accordance with the instructions, may cause harmful interference to radio communications. However, there is no guarantee that interference will not occur in a particular installation. If this equipment does cause harmful interference to radio or television reception, which can be determined by turning the equipment off and on, the user is encouraged to try to correct the interference by one or more of the following measures:*

- Reorient or relocate the receiving antenna.
- Increase the separation between the equipment and receiver.
- Connect the equipment into an outlet on a circuit different from that to which the receiver is connected.
- Consult the dealer or an experienced radio/TV technician for help.

### 3.2 Canada

3.2.1 For EVMs issued with an Industry Canada Certificate of Conformance to RSS-210

#### Concerning EVMs Including Radio Transmitters:

This device complies with Industry Canada license-exempt RSS standard(s). Operation is subject to the following two conditions: (1) this device may not cause interference, and (2) this device must accept any interference, including interference that may cause undesired operation of the device.

#### Concernant les EVMs avec appareils radio:

Le présent appareil est conforme aux CNR d'Industrie Canada applicables aux appareils radio exempts de licence. L'exploitation est autorisée aux deux conditions suivantes: (1) l'appareil ne doit pas produire de brouillage, et (2) l'utilisateur de l'appareil doit accepter tout brouillage radioélectrique subi, même si le brouillage est susceptible d'en compromettre le fonctionnement.

#### Concerning EVMs Including Detachable Antennas:

Under Industry Canada regulations, this radio transmitter may only operate using an antenna of a type and maximum (or lesser) gain approved for the transmitter by Industry Canada. To reduce potential radio interference to other users, the antenna type and its gain should be so chosen that the equivalent isotropically radiated power (e.i.r.p.) is not more than that necessary for successful communication. This radio transmitter has been approved by Industry Canada to operate with the antenna types listed in the user guide with the maximum permissible gain and required antenna impedance for each antenna type indicated. Antenna types not included in this list, having a gain greater than the maximum gain indicated for that type, are strictly prohibited for use with this device.

#### Concernant les EVMs avec antennes détachables

Conformément à la réglementation d'Industrie Canada, le présent émetteur radio peut fonctionner avec une antenne d'un type et d'un gain maximal (ou inférieur) approuvé pour l'émetteur par Industrie Canada. Dans le but de réduire les risques de brouillage radioélectrique à l'intention des autres utilisateurs, il faut choisir le type d'antenne et son gain de sorte que la puissance isotrope rayonnée équivalente (p.i.r.e.) ne dépasse pas l'intensité nécessaire à l'établissement d'une communication satisfaisante. Le présent émetteur radio a été approuvé par Industrie Canada pour fonctionner avec les types d'antenne énumérés dans le manuel d'usage et ayant un gain admissible maximal et l'impédance requise pour chaque type d'antenne. Les types d'antenne non inclus dans cette liste, ou dont le gain est supérieur au gain maximal indiqué, sont strictement interdits pour l'exploitation de l'émetteur.

### 3.3 Japan

3.3.1 *Notice for EVMs delivered in Japan:* Please see [http://www.tij.co.jp/lstds/ti\\_ja/general/eStore/notice\\_01.page](http://www.tij.co.jp/lstds/ti_ja/general/eStore/notice_01.page) 日本国内に輸入される評価用キット、ボードについては、次のところをご覧ください。  
[http://www.tij.co.jp/lstds/ti\\_ja/general/eStore/notice\\_01.page](http://www.tij.co.jp/lstds/ti_ja/general/eStore/notice_01.page)

3.3.2 *Notice for Users of EVMs Considered "Radio Frequency Products" in Japan:* EVMs entering Japan may not be certified by TI as conforming to Technical Regulations of Radio Law of Japan.

If User uses EVMs in Japan, not certified to Technical Regulations of Radio Law of Japan, User is required by Radio Law of Japan to follow the instructions below with respect to EVMs:

1. Use EVMs in a shielded room or any other test facility as defined in the notification #173 issued by Ministry of Internal Affairs and Communications on March 28, 2006, based on Sub-section 1.1 of Article 6 of the Ministry's Rule for Enforcement of Radio Law of Japan,
2. Use EVMs only after User obtains the license of Test Radio Station as provided in Radio Law of Japan with respect to EVMs, or
3. Use of EVMs only after User obtains the Technical Regulations Conformity Certification as provided in Radio Law of Japan with respect to EVMs. Also, do not transfer EVMs, unless User gives the same notice above to the transferee. Please note that if User does not follow the instructions above, User will be subject to penalties of Radio Law of Japan.

【無線電波を送信する製品の開発キットをお使いになる際の注意事項】 開発キットの中には技術基準適合証明を受けていないものがあります。技術適合証明を受けていないものご使用に際しては、電波法遵守のため、以下のいずれかの措置を取っていただく必要がありますのでご注意ください。

1. 電波法施行規則第6条第1項第1号に基づく平成18年3月28日総務省告示第173号で定められた電波暗室等の試験設備でご使用いただく。
2. 実験局の免許を取得後ご使用いただく。
3. 技術基準適合証明を取得後ご使用いただく。

なお、本製品は、上記の「ご使用にあたっての注意」を譲渡先、移転先に通知しない限り、譲渡、移転できないものとします。

上記を遵守頂けない場合は、電波法の罰則が適用される可能性があることをご留意ください。日本テキサス・インスツルメンツ株式会社

東京都新宿区西新宿 6 丁目 2 4 番 1 号

西新宿三井ビル

3.3.3 *Notice for EVMs for Power Line Communication:* Please see [http://www.tij.co.jp/llds/ti\\_ja/general/eStore/notice\\_02.page](http://www.tij.co.jp/llds/ti_ja/general/eStore/notice_02.page)

電力線搬送波通信についての開発キットをお使いになる際の注意事項については、次のところをご覧ください。[http://www.tij.co.jp/llds/ti\\_ja/general/eStore/notice\\_02.page](http://www.tij.co.jp/llds/ti_ja/general/eStore/notice_02.page)

#### 4 *EVM Use Restrictions and Warnings:*

4.1 EVMS ARE NOT FOR USE IN FUNCTIONAL SAFETY AND/OR SAFETY CRITICAL EVALUATIONS, INCLUDING BUT NOT LIMITED TO EVALUATIONS OF LIFE SUPPORT APPLICATIONS.

4.2 User must read and apply the user guide and other available documentation provided by TI regarding the EVM prior to handling or using the EVM, including without limitation any warning or restriction notices. The notices contain important safety information related to, for example, temperatures and voltages.

#### 4.3 *Safety-Related Warnings and Restrictions:*

4.3.1 User shall operate the EVM within TI's recommended specifications and environmental considerations stated in the user guide, other available documentation provided by TI, and any other applicable requirements and employ reasonable and customary safeguards. Exceeding the specified performance ratings and specifications (including but not limited to input and output voltage, current, power, and environmental ranges) for the EVM may cause personal injury or death, or property damage. If there are questions concerning performance ratings and specifications, User should contact a TI field representative prior to connecting interface electronics including input power and intended loads. Any loads applied outside of the specified output range may also result in unintended and/or inaccurate operation and/or possible permanent damage to the EVM and/or interface electronics. Please consult the EVM user guide prior to connecting any load to the EVM output. If there is uncertainty as to the load specification, please contact a TI field representative. During normal operation, even with the inputs and outputs kept within the specified allowable ranges, some circuit components may have elevated case temperatures. These components include but are not limited to linear regulators, switching transistors, pass transistors, current sense resistors, and heat sinks, which can be identified using the information in the associated documentation. When working with the EVM, please be aware that the EVM may become very warm.

4.3.2 EVMS are intended solely for use by technically qualified, professional electronics experts who are familiar with the dangers and application risks associated with handling electrical mechanical components, systems, and subsystems. User assumes all responsibility and liability for proper and safe handling and use of the EVM by User or its employees, affiliates, contractors or designees. User assumes all responsibility and liability to ensure that any interfaces (electronic and/or mechanical) between the EVM and any human body are designed with suitable isolation and means to safely limit accessible leakage currents to minimize the risk of electrical shock hazard. User assumes all responsibility and liability for any improper or unsafe handling or use of the EVM by User or its employees, affiliates, contractors or designees.

4.4 User assumes all responsibility and liability to determine whether the EVM is subject to any applicable international, federal, state, or local laws and regulations related to User's handling and use of the EVM and, if applicable, User assumes all responsibility and liability for compliance in all respects with such laws and regulations. User assumes all responsibility and liability for proper disposal and recycling of the EVM consistent with all applicable international, federal, state, and local requirements.

5. *Accuracy of Information:* To the extent TI provides information on the availability and function of EVMS, TI attempts to be as accurate as possible. However, TI does not warrant the accuracy of EVM descriptions, EVM availability or other information on its websites as accurate, complete, reliable, current, or error-free.

6. *Disclaimers:*
- 6.1 EXCEPT AS SET FORTH ABOVE, EVMS AND ANY WRITTEN DESIGN MATERIALS PROVIDED WITH THE EVM (AND THE DESIGN OF THE EVM ITSELF) ARE PROVIDED "AS IS" AND "WITH ALL FAULTS." TI DISCLAIMS ALL OTHER WARRANTIES, EXPRESS OR IMPLIED, REGARDING SUCH ITEMS, INCLUDING BUT NOT LIMITED TO ANY IMPLIED WARRANTIES OF MERCHANTABILITY OR FITNESS FOR A PARTICULAR PURPOSE OR NON-INFRINGEMENT OF ANY THIRD PARTY PATENTS, COPYRIGHTS, TRADE SECRETS OR OTHER INTELLECTUAL PROPERTY RIGHTS.
- 6.2 EXCEPT FOR THE LIMITED RIGHT TO USE THE EVM SET FORTH HEREIN, NOTHING IN THESE TERMS AND CONDITIONS SHALL BE CONSTRUED AS GRANTING OR CONFERRING ANY RIGHTS BY LICENSE, PATENT, OR ANY OTHER INDUSTRIAL OR INTELLECTUAL PROPERTY RIGHT OF TI, ITS SUPPLIERS/LICENSORS OR ANY OTHER THIRD PARTY, TO USE THE EVM IN ANY FINISHED END-USER OR READY-TO-USE FINAL PRODUCT, OR FOR ANY INVENTION, DISCOVERY OR IMPROVEMENT MADE, CONCEIVED OR ACQUIRED PRIOR TO OR AFTER DELIVERY OF THE EVM.
7. *USER'S INDEMNITY OBLIGATIONS AND REPRESENTATIONS.* USER WILL DEFEND, INDEMNIFY AND HOLD TI, ITS LICENSORS AND THEIR REPRESENTATIVES HARMLESS FROM AND AGAINST ANY AND ALL CLAIMS, DAMAGES, LOSSES, EXPENSES, COSTS AND LIABILITIES (COLLECTIVELY, "CLAIMS") ARISING OUT OF OR IN CONNECTION WITH ANY HANDLING OR USE OF THE EVM THAT IS NOT IN ACCORDANCE WITH THESE TERMS AND CONDITIONS. THIS OBLIGATION SHALL APPLY WHETHER CLAIMS ARISE UNDER STATUTE, REGULATION, OR THE LAW OF TORT, CONTRACT OR ANY OTHER LEGAL THEORY, AND EVEN IF THE EVM FAILS TO PERFORM AS DESCRIBED OR EXPECTED.
8. *Limitations on Damages and Liability:*
- 8.1 *General Limitations.* IN NO EVENT SHALL TI BE LIABLE FOR ANY SPECIAL, COLLATERAL, INDIRECT, PUNITIVE, INCIDENTAL, CONSEQUENTIAL, OR EXEMPLARY DAMAGES IN CONNECTION WITH OR ARISING OUT OF THESE TERMS AND CONDITIONS OR THE USE OF THE EVMS PROVIDED HEREUNDER, REGARDLESS OF WHETHER TI HAS BEEN ADVISED OF THE POSSIBILITY OF SUCH DAMAGES. EXCLUDED DAMAGES INCLUDE, BUT ARE NOT LIMITED TO, COST OF REMOVAL OR REINSTALLATION, ANCILLARY COSTS TO THE PROCUREMENT OF SUBSTITUTE GOODS OR SERVICES, RETESTING, OUTSIDE COMPUTER TIME, LABOR COSTS, LOSS OF GOODWILL, LOSS OF PROFITS, LOSS OF SAVINGS, LOSS OF USE, LOSS OF DATA, OR BUSINESS INTERRUPTION. NO CLAIM, SUIT OR ACTION SHALL BE BROUGHT AGAINST TI MORE THAN ONE YEAR AFTER THE RELATED CAUSE OF ACTION HAS OCCURRED.
- 8.2 *Specific Limitations.* IN NO EVENT SHALL TI'S AGGREGATE LIABILITY FROM ANY WARRANTY OR OTHER OBLIGATION ARISING OUT OF OR IN CONNECTION WITH THESE TERMS AND CONDITIONS, OR ANY USE OF ANY TI EVM PROVIDED HEREUNDER, EXCEED THE TOTAL AMOUNT PAID TO TI FOR THE PARTICULAR UNITS SOLD UNDER THESE TERMS AND CONDITIONS WITH RESPECT TO WHICH LOSSES OR DAMAGES ARE CLAIMED. THE EXISTENCE OF MORE THAN ONE CLAIM AGAINST THE PARTICULAR UNITS SOLD TO USER UNDER THESE TERMS AND CONDITIONS SHALL NOT ENLARGE OR EXTEND THIS LIMIT.
9. *Return Policy.* Except as otherwise provided, TI does not offer any refunds, returns, or exchanges. Furthermore, no return of EVM(s) will be accepted if the package has been opened and no return of the EVM(s) will be accepted if they are damaged or otherwise not in a resalable condition. If User feels it has been incorrectly charged for the EVM(s) it ordered or that delivery violates the applicable order, User should contact TI. All refunds will be made in full within thirty (30) working days from the return of the components(s), excluding any postage or packaging costs.
10. *Governing Law:* These terms and conditions shall be governed by and interpreted in accordance with the laws of the State of Texas, without reference to conflict-of-laws principles. User agrees that non-exclusive jurisdiction for any dispute arising out of or relating to these terms and conditions lies within courts located in the State of Texas and consents to venue in Dallas County, Texas. Notwithstanding the foregoing, any judgment may be enforced in any United States or foreign court, and TI may seek injunctive relief in any United States or foreign court.

Mailing Address: Texas Instruments, Post Office Box 655303, Dallas, Texas 75265  
Copyright © 2015, Texas Instruments Incorporated



## IMPORTANT NOTICE

Texas Instruments Incorporated and its subsidiaries (TI) reserve the right to make corrections, enhancements, improvements and other changes to its semiconductor products and services per JESD46, latest issue, and to discontinue any product or service per JESD48, latest issue. Buyers should obtain the latest relevant information before placing orders and should verify that such information is current and complete. All semiconductor products (also referred to herein as "components") are sold subject to TI's terms and conditions of sale supplied at the time of order acknowledgment.

TI warrants performance of its components to the specifications applicable at the time of sale, in accordance with the warranty in TI's terms and conditions of sale of semiconductor products. Testing and other quality control techniques are used to the extent TI deems necessary to support this warranty. Except where mandated by applicable law, testing of all parameters of each component is not necessarily performed.

TI assumes no liability for applications assistance or the design of Buyers' products. Buyers are responsible for their products and applications using TI components. To minimize the risks associated with Buyers' products and applications, Buyers should provide adequate design and operating safeguards.

TI does not warrant or represent that any license, either express or implied, is granted under any patent right, copyright, mask work right, or other intellectual property right relating to any combination, machine, or process in which TI components or services are used. Information published by TI regarding third-party products or services does not constitute a license to use such products or services or a warranty or endorsement thereof. Use of such information may require a license from a third party under the patents or other intellectual property of the third party, or a license from TI under the patents or other intellectual property of TI.

Reproduction of significant portions of TI information in TI data books or data sheets is permissible only if reproduction is without alteration and is accompanied by all associated warranties, conditions, limitations, and notices. TI is not responsible or liable for such altered documentation. Information of third parties may be subject to additional restrictions.

Resale of TI components or services with statements different from or beyond the parameters stated by TI for that component or service voids all express and any implied warranties for the associated TI component or service and is an unfair and deceptive business practice. TI is not responsible or liable for any such statements.

Buyer acknowledges and agrees that it is solely responsible for compliance with all legal, regulatory and safety-related requirements concerning its products, and any use of TI components in its applications, notwithstanding any applications-related information or support that may be provided by TI. Buyer represents and agrees that it has all the necessary expertise to create and implement safeguards which anticipate dangerous consequences of failures, monitor failures and their consequences, lessen the likelihood of failures that might cause harm and take appropriate remedial actions. Buyer will fully indemnify TI and its representatives against any damages arising out of the use of any TI components in safety-critical applications.

In some cases, TI components may be promoted specifically to facilitate safety-related applications. With such components, TI's goal is to help enable customers to design and create their own end-product solutions that meet applicable functional safety standards and requirements. Nonetheless, such components are subject to these terms.

No TI components are authorized for use in FDA Class III (or similar life-critical medical equipment) unless authorized officers of the parties have executed a special agreement specifically governing such use.

Only those TI components which TI has specifically designated as military grade or "enhanced plastic" are designed and intended for use in military/aerospace applications or environments. Buyer acknowledges and agrees that any military or aerospace use of TI components which have **not** been so designated is solely at the Buyer's risk, and that Buyer is solely responsible for compliance with all legal and regulatory requirements in connection with such use.

TI has specifically designated certain components as meeting ISO/TS16949 requirements, mainly for automotive use. In any case of use of non-designated products, TI will not be responsible for any failure to meet ISO/TS16949.

### Products

Audio	<a href="http://www.ti.com/audio">www.ti.com/audio</a>
Amplifiers	<a href="http://amplifier.ti.com">amplifier.ti.com</a>
Data Converters	<a href="http://dataconverter.ti.com">dataconverter.ti.com</a>
DLP® Products	<a href="http://www.dlp.com">www.dlp.com</a>
DSP	<a href="http://dsp.ti.com">dsp.ti.com</a>
Clocks and Timers	<a href="http://www.ti.com/clocks">www.ti.com/clocks</a>
Interface	<a href="http://interface.ti.com">interface.ti.com</a>
Logic	<a href="http://logic.ti.com">logic.ti.com</a>
Power Mgmt	<a href="http://power.ti.com">power.ti.com</a>
Microcontrollers	<a href="http://microcontroller.ti.com">microcontroller.ti.com</a>
RFID	<a href="http://www.ti-rfid.com">www.ti-rfid.com</a>
OMAP Applications Processors	<a href="http://www.ti.com/omap">www.ti.com/omap</a>
Wireless Connectivity	<a href="http://www.ti.com/wirelessconnectivity">www.ti.com/wirelessconnectivity</a>

### Applications

Automotive and Transportation	<a href="http://www.ti.com/automotive">www.ti.com/automotive</a>
Communications and Telecom	<a href="http://www.ti.com/communications">www.ti.com/communications</a>
Computers and Peripherals	<a href="http://www.ti.com/computers">www.ti.com/computers</a>
Consumer Electronics	<a href="http://www.ti.com/consumer-apps">www.ti.com/consumer-apps</a>
Energy and Lighting	<a href="http://www.ti.com/energy">www.ti.com/energy</a>
Industrial	<a href="http://www.ti.com/industrial">www.ti.com/industrial</a>
Medical	<a href="http://www.ti.com/medical">www.ti.com/medical</a>
Security	<a href="http://www.ti.com/security">www.ti.com/security</a>
Space, Avionics and Defense	<a href="http://www.ti.com/space-avionics-defense">www.ti.com/space-avionics-defense</a>
Video and Imaging	<a href="http://www.ti.com/video">www.ti.com/video</a>

### TI E2E Community

[e2e.ti.com](http://e2e.ti.com)