

G3VM-41PR□/51PR

MOS FET Relays USOP package with Low Output Capacitance and ON Resistance type (Low C × R)

USOP Package with Low Output Capacitance and ON Resistance

- Load voltage 40V/50V

RoHS Compliant

⚠ Refer to "Common Precautions".



NEW

Note: The actual product is marked differently from the image shown here.

Application Examples

- Semiconductor test equipment
- Communication equipment
- Test & measurement equipment
- Data loggers

Package (Unit : mm, Average)

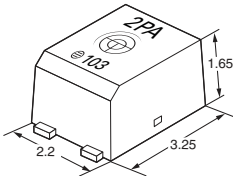

Note: The actual product is marked differently from the image shown here.

Model Number Legend

G3VM-□□□□□
1 2 3 4 5

1. Load Voltage

- 4: 40V
- 5: 50V

2. Contact form

- 1: 1a (SPST-NO)

3. Package type

- P: USOP 4 pin

4. Additional functions

- R: Low On-resistance

5. Other informations

When specifications overlap, serial code is added in the recorded order.

Ordering Information

Package type	Contact form	Terminals	Load voltage (peak value) *	Continuous load current (peak value) *	Packing/Tape cut		Packing/Tape & reel	
					Model	Minimum package quantity	Model	Minimum package quantity
USOP4	1a (SPST-NO)	Surface-mounting Terminals	40V	100mA	G3VM-41PR12	1 pc.	G3VM-41PR12(TR05)	500 pcs.
				120mA	G3VM-41PR6		G3VM-41PR6(TR05)	
				140mA	G3VM-41PR10		G3VM-41PR10(TR05)	
				300mA	G3VM-41PR11		G3VM-41PR11(TR05)	
				300mA	G3VM-41PR5		G3VM-41PR5(TR05)	
				50V	300mA		G3VM-51PR	

Note: When ordering tape packing, add "(TR05)" (500pcs/reel) to the model number. Ask your OMRON representative for orders under 500 pcs. We can supply products with the tape already cut. Tape-cut USOPs are packaged without humidity resistance. Use manual soldering to mount them. Refer to common precautions.

* The AC peak and DC value are given for the load voltage and continuous load current.

Absolute Maximum Ratings (Ta = 25°C)

Item		Symbol	G3VM-41PR12	G3VM-41PR6	G3VM-41PR10	G3VM-41PR11	G3VM-41PR5	G3VM-51PR	Unit	Measurement conditions	
Input	LED forward current	IF	50							mA	
	LED forward current reduction rate	ΔIF/°C	-0.5							mA/°C	Ta≥25°C
	LED reverse voltage	VR	5							V	
	Connection temperature	TJ	125							°C	
Output	Load voltage (AC peak/DC)	V _{OFF}	40				50			V	
	Continuous load current (AC peak/DC)	Io	100	120	140	300			mA		
	ON current reduction rate	ΔIo/°C	-1.0	-1.2	-1.4	-3			mA/°C	Ta≥25°C	
	Pulse ON current	I _{op}	300	360	420	900			mA	t=100ms, Duty=1/10	
	Connection temperature	TJ	125							°C	
Dielectric strength between I/O *		V _{I-O}	500							V _{rms}	AC for 1 min
Ambient operating temperature		Ta	-40~+85							°C	With no icing or condensation
Ambient storage temperature		T _{stg}	-40~+125							°C	
Soldering temperature		-	260							°C	10s

* The dielectric strength between the input and output was checked by applying voltage between all pins as a group on the LED side and all pins as a group on the light-receiving side.

USOP / 41PR□ / 51PR

■Electrical Characteristics (Ta = 25°C)

Item		Symbol	G3VM-41PR12	G3VM-41PR6	G3VM-41PR10	G3VM-41PR11	G3VM-41PR5	G3VM-51PR	Unit	Measurement conditions						
Input	LED forward voltage	V _F	Minimum						1.0	V	I _F =10mA					
		Typical						1.15								
		Maximum						1.3								
	Reverse current	I _R	Maximum						10	μA	V _R =5V					
	Capacity between terminals	C _T	Typical						15	pF	V=0, f=1MHz					
Output	Trigger LED forward current	I _{FT}	1.0	0.6	0.5	1.0	0.6	0.5	mA	I _O =100mA						
		Maximum						3								
	Release LED forward current	I _{FC}	Minimum						0.1	0.2	mA	I _{OFF} =10μA				
Output	Maximum resistance with output ON	R _{ON}	Typical						15	Ω	I _F =5mA, t<1s I _O =Continuous load current ratings					
		Maximum						20	15			14	10	1.5		
	Current leakage when the relay is open	I _{LEAK}	Maximum						1	0.2	1	nA	V _{OFF} =Load voltage ratings			
Output	Capacity between terminals	C _{OFF}	Typical						0.3	1	0.45	0.7	10	12	pF	V=0, f=100MHz, t<1s
		Maximum						0.6	2	0.8	1.3	14	-			
Capacity between I/O terminals		C _{I-O}	Typical						0.4			pF	f=1MHz, V _S =0V			
Output	Insulation resistance between I/O terminals	R _{I-O}	Minimum						1000			MΩ	V _{I-O} =500VDC, R _{oH} ≤60%			
		Typical						10 ⁹								
Output	Turn-ON time	t _{ON}	Typical		0.04	0.05	0.03	0.04	0.2		ms	I _F =5mA, R _L =200Ω, V _{DD} =20V *1				
		Maximum		0.2						0.5						
Output	Turn-OFF time	t _{OFF}	Typical		0.12	0.16	0.2	0.14	0.2	0.1						
		Maximum		0.2	0.3		0.2	0.3	0.4							
Output	Equivalent rise time	ERT	Typical						-		40	ps	I _F =5mA, V _{DD} =0.25V, Tr(in)=25ps *2			
		Maximum						-		90						

*1. Turn-ON and Turn-OFF Times

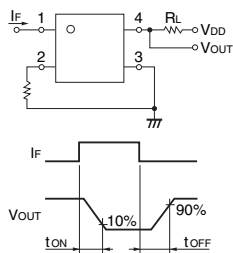

*2. Equivalent Rise Time

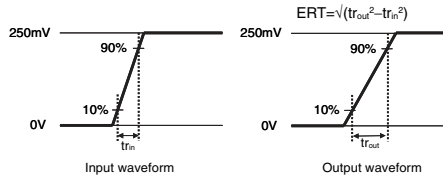

■Recommended Operating Conditions

For usage with high reliability, Recommended Operation Conditions is a measure that takes into account the derating of Absolute Maximum Ratings and Electrical Characteristics.

Each item on this list is an independent condition, so it is not simultaneously satisfy several conditions.

Item	Symbol	Maximum	G3VM-41PR12	G3VM-41PR6	G3VM-41PR10	G3VM-41PR11	G3VM-41PR5	G3VM-51PR	Unit
Load voltage (AC peak/DC)	V _{DD}	Maximum	32					40	V
Operating LED forward current	I _F	Minimum	5						mA
		Typical	7.5						
		Maximum	20						
Continuous load current (AC peak/DC)	I _O	Maximum	100	120		140	300		
Ambient operating temperature	T _a	Minimum	-20						°C
		Maximum	65						

Engineering Data

LED forward current vs. Ambient temperature

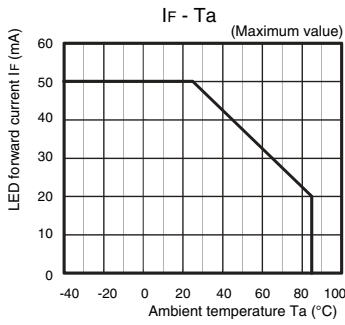

Continuous load current vs. Ambient temperature

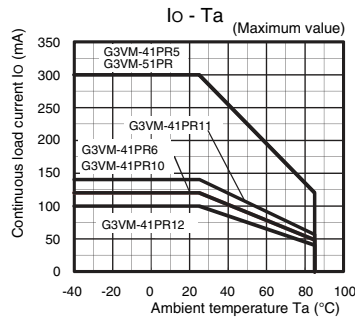

LED forward current vs. LED forward voltage

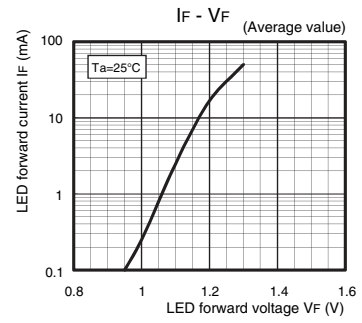

Continuous load current vs. On-state voltage

G3VM-41PR5/41PR6

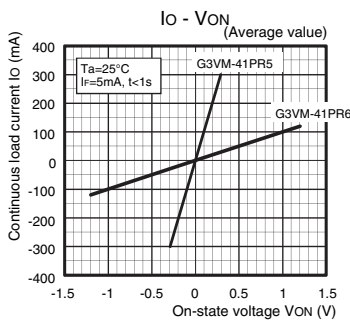

G3VM-41PR10/41PR11/41PR12/51PR

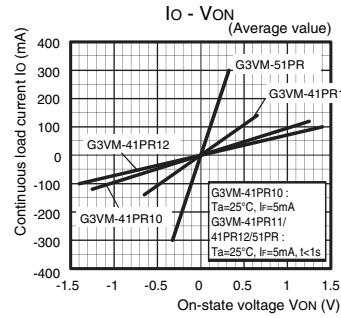

On-state resistance vs. Ambient temperature

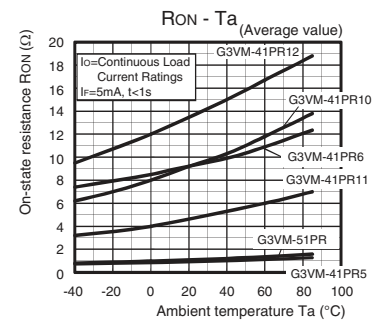

Trigger LED forward current vs. Ambient temperature

G3VM-41PR5/41PR6

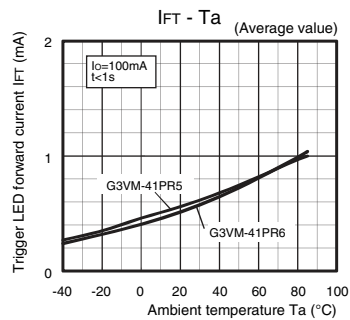

G3VM-41PR10/41PR11/41PR12/51PR

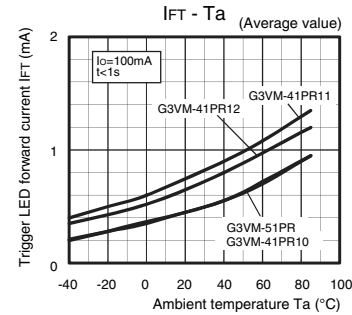

Turn ON, Turn OFF time vs. LED forward current

G3VM-41PR5/41PR6

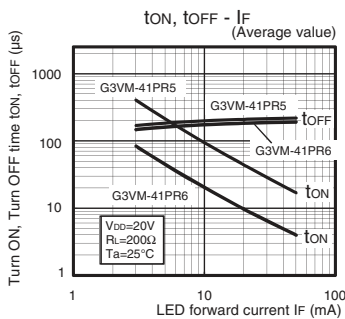

G3VM-41PR10/41PR11/41PR12

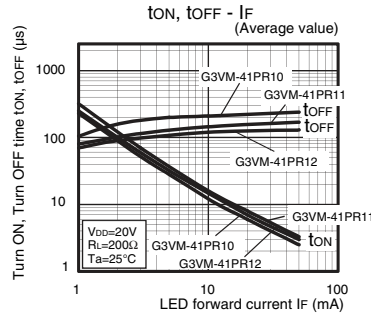

G3VM-51PR

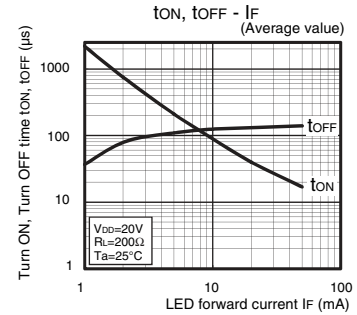

Engineering Data

Turn ON, Turn OFF time vs. Ambient temperature

G3VM-41PR5/41PR6

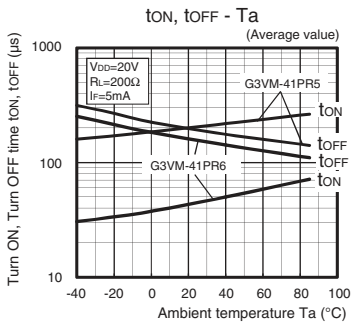

G3VM-41PR10/41PR11/41PR12

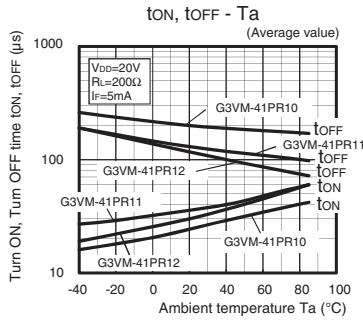

G3VM-51PR

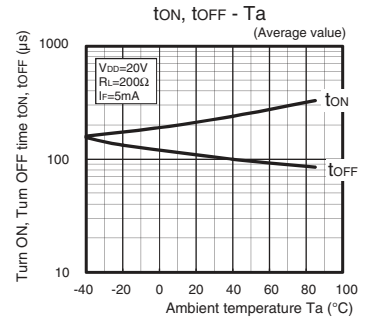

Output terminal capacitance vs. Load voltage

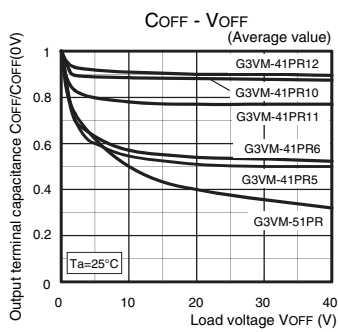

Current leakage vs. Load voltage

G3VM-41PR5/41PR6

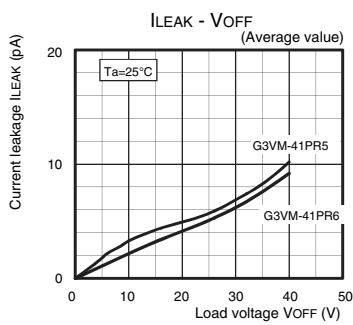

G3VM-41PR10/41PR11/41PR12/51PR

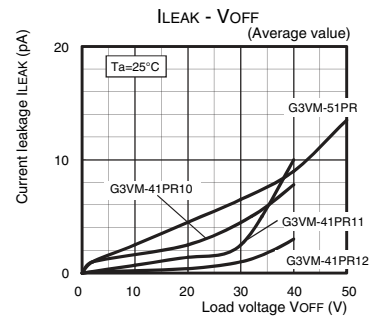

■Appearance / Terminal Arrangement / Internal Connections

■Appearance

USOP (Ultra Small Outline Package)
USOP4 pin

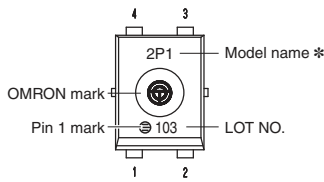

* Actual model name marking for each model

Model	Marking
G3VM-41PR12	4PC
G3VM-41PR6	4P6
G3VM-41PR10	4PA
G3VM-41PR11	4PB
G3VM-41PR5	4P5
G3VM-51PR	5P0

■Terminal Arrangement/Internal Connections (Top View)

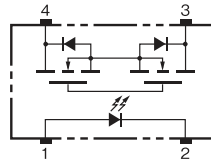

Note. The actual product is marked differently from the image shown here.

■Dimensions (Unit: mm)

Surface-mounting Terminals

Weight: 0.03g

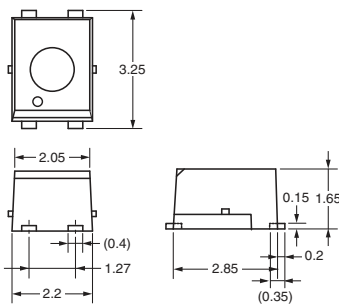
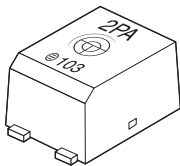

Unless otherwise specified, the dimensional tolerance is ± 0.2 mm.

Actual Mounting Pad Dimensions

(Recommended Value, Top View)

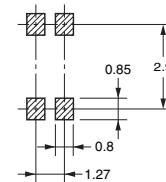

Unless otherwise specified, the dimensional tolerance is ± 0.2 mm.

Note: The actual product is marked differently from the image shown here.

■Approved Standards

UL recognized

Approved Standards	Contact form	File No.
UL recognized	1a (SPST-NO)	E80555

■Safety Precautions

- Refer to "Common Precautions" for all G3VM models.

Please check each region's Terms & Conditions by region website.

OMRON Corporation

Electronic and Mechanical Components Company

Regional Contact

Americas
<https://www.components.omron.com/>

Asia-Pacific
<https://ecb.omron.com.sg/>

Korea
<https://www.omron-ecb.co.kr/>

Europe
<http://components.omron.eu/>

China
<https://www.ecb.omron.com.cn/>

Japan
<https://www.omron.co.jp/ecb/>