

HW025 Dual Positive Output-Series Power Modules: dc-dc Converter: 36 Vdc to 75 Vdc Input, Dual Positive Outputs; 25 W

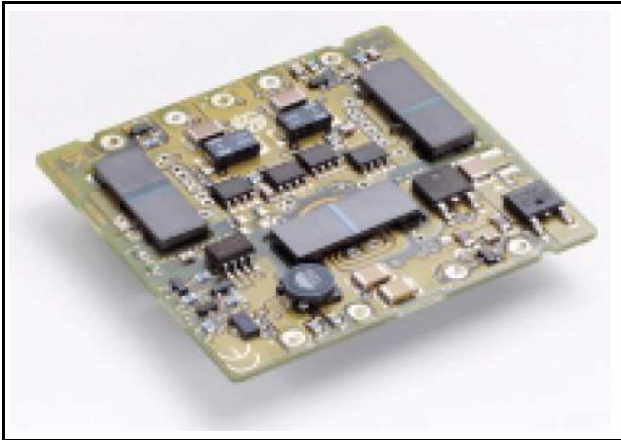

The HW025 Dual Positive Output-Series Power Modules use advanced, surface-mount technology and deliver high-quality, efficient, and compact dc-dc conversion.

Applications

- Distributed power architectures
- Communications equipment
- Computer equipment

Options

- Remote on/off logic choice (positive or negative)
- Surface Mount
- Basic Insulation

Description

The HW025 Dual Positive Output-Series Power Modules are open frame dc-dc converters that operate over an input voltage range of 36 Vdc to 75 Vdc and provide precisely regulated dual positive outputs. The modules have a maximum power rating of 25 W at a typical full-load efficiency of 80%. The HW025 Dual Positive Output-Series provides two independently regulated outputs. The circuit architecture allows power to be traded between the two outputs, while maintaining a high efficiency.

Features

- Low profile
- Small size: 54.4 mm x 57.4 mm x 7.5 mm (2.14 in. x 2.26 in. x 0.29 in.)
- High efficiency: 85% typical
- Two tightly regulated outputs
- Flexible current allocation between outputs
- Fixed frequency
- Remote on/off
- Output voltage adjustment (trim)
- Output overcurrent protection
- Overtemperature protection
- Meets the voltage isolation requirements for ETSI 300-132-2 and complies with and is Licensed for Basic Insulation rating per EN60950.
- Wide operating temperature range (–40 °C to 90 °C)
- *UL** 60950 Recognized, *CSA*† C22.2 No. 60950-00 Certified, and *VDE*‡ 0805 (IEC60950) Licensed
- CE mark meets 73/23/EEC and 93/68/EEC directives§

* *UL* is a registered trademark of Underwriters Laboratories, Inc.

† *CSA* is a registered trademark of Canadian Standards Association.

‡ *VDE* is a trademark of Verband Deutscher Elektrotechniker e.V.

§ This product is intended for integration into end-use equipment. All the required procedures for CE marking of end-use equipment should be followed. (The CE mark is placed on selected products.)

Absolute Maximum Ratings

Stresses in excess of the absolute maximum ratings can cause permanent damage to the device. These are absolute stress ratings only. Functional operation of the device is not implied at these or any other conditions in excess of those given in the operations sections of the data sheet. Exposure to absolute maximum ratings for extended periods can adversely affect device reliability.

Parameter	Symbol	Min	Max	Unit
Input Voltage: Continuous	V_I	—	80	Vdc
Transient (2ms)	$V_{I, trans}$	—	100	V
Operating Ambient Temperature (See Thermal Considerations section)	T_A	-40	100	°C
Storage Temperature	T_{stg}	-55	105	°C
I/O Isolation Voltage	—	—	1500	Vdc

Electrical Specifications

Unless otherwise indicated, specifications apply over all operating input voltage, resistive load, and temperature conditions.

Table 1. Input Specifications

Parameter	Symbol	Min	Typ	Max	Unit
Operating Input Voltage	V_I	36	48	75	Vdc
Maximum Input Current ($V_I = 0$ V to 75 V; $I_O = I_{O, max}$; see Figures 1 and 2.)	$I_{I, max}$	—	—	1.1	A
Inrush Transient	—	—	—	1.0	A ² s
Input Reflected-ripple Current, Peak-to-peak (5 Hz to 20 MHz, 12 μ H source impedance; see Figure 15)	I_I	—	4	—	mAp-p
Input Ripple Rejection (120 Hz)	—	—	54	—	dB
EMC, EN55022 (V_I, nom , full load)	See EMC Considerations section.				

Fusing Considerations

CAUTION: This power module is not internally fused. An input line fuse must always be used.

This power module can be used in a wide variety of applications, ranging from simple stand-alone operation to an integrated part of a sophisticated power architecture. To preserve maximum flexibility, internal fusing is not included; however, to achieve maximum safety and system protection, always use an input line fuse. The safety agencies require a normal-blow fuse with a maximum rating of 3 A (see Safety Considerations section). Based on the information provided in this data sheet on inrush energy and maximum dc input current, the same type of fuse with a lower rating can be used. Refer to the fuse manufacturer's data for further information.

Electrical Specifications (continued)

Table 2. Output Specifications

Parameter	Device	Symbol	Min	Typ	Max	Unit
Output Voltage Set Point ($V_I = 48\text{ V}$; $I_{O1} = I_{O2} = 2.5\text{ A}$; $T_A = 25\text{ }^\circ\text{C}$)	HW025AF	$V_{O1, \text{set}}$	4.92	5.00	5.08	Vdc
		$V_{O2, \text{set}}$	3.25	3.30	3.35	Vdc
	HW025FG	$V_{O1, \text{set}}$	3.25	3.30	3.35	Vdc
		$V_{O2, \text{set}}$	2.46	2.50	2.54	Vdc
Output Voltage (Over all operating input voltage, resistive load, and temperature conditions until end of life.)	HW025AF	V_{O1}	4.78	—	5.21	Vdc
		V_{O2}	3.16	—	3.44	Vdc
	HW025FG	V_{O1}	3.16	—	3.44	Vdc
		V_{O2}	2.39	—	2.61	Vdc
Output Regulation: Line ($V_I = 36\text{ V to }75\text{ V}$) Load ($I_O = I_{O, \text{min}}$ to $I_{O, \text{max}}$) Temperature ($T_A = -40\text{ }^\circ\text{C to }+70\text{ }^\circ\text{C}$)	All	—	—	0.01	0.2	%Vo
	All	—	—	0.05	0.2	%Vo
	All	—	—	0.60	2.0	%Vo
Output Ripple and Noise Voltage (see Figures 9 and 16): RMS (5 Hz to 20 MHz bandwidth) Peak-to-peak (5 Hz to 20 MHz bandwidth)	All	—	—	—	30	mVrms
	All	—	—	70	100	mVp-p
External Load Capacitance	All	$C_{VO1, \text{max}}$	0	—	100*	μF
		$C_{VO2, \text{max}}$	0	—	100*	μF
Output Current NOTE: The maximum combined output current must not exceed 5A.	All	I_{O1}	0.0	—	4.0	Adc
	All	I_{O2}	0.0	—	4.0	Adc
	All	$I_{O, \text{TOT}}$	0.0	—	5.0	Adc
Output Current-limit Inception ($V_O = 90\%$ of $V_{O, \text{nom}}$)	HW025AF	$I_{O, \text{cli}}$	—	—	9^\dagger	A
	HW025FG	$I_{O, \text{cli}}$	—	—	9^\dagger	A
Output Short-circuit Current ($V_O = 250\text{ mV}$)	All	$I_{O, \text{SL}}$	—	1.0	—	Adc
Efficiency for $V_{O1} = 5.0\text{ V}$, $V_{O2} = 3.3\text{ V}$ ($V_I = 48\text{ V}$, $I_{O1} = I_{O2} = 2.5\text{ A}$, $T_{\text{ref}} = 25\text{ }^\circ\text{C}$) for $V_{O1} = 3.3\text{ V}$, $V_{O2} = 2.5\text{ V}$ ($V_I = 48\text{ V}$, $I_{O1} = I_{O2} = 2.5\text{ A}$, $T_{\text{ref}} = 25\text{ }^\circ\text{C}$)	HW025AF	η	82	85	—	%
	HW025FG	η	80	83	—	%
Switching Frequency	All	—	—	300	—	kHz

* It is recommended that the output capacitance's are balanced, where possible. Consult your sales representative or the factory for higher capacitance.

† These are manufacturing test limits. In some situations, results may differ.

Electrical Specifications (continued)

Table 2. Output Specifications (continued)

Parameter	Device	Symbol	Min	Typ	Max	Unit
Dynamic Response ($\Delta I_o/\Delta t = 1 \text{ A}/10 \mu\text{s}$, $V_I = 48 \text{ V}$, $T_{\text{ref}} = 25 \text{ }^\circ\text{C}$): Load Change from IO1 = 50% to 75% of I_{o1} , max or $I_{o1} = 50\%$ to 25% of IO1, max; $I_{o2} = 30\%$ of I_{o2} , max: Peak Deviation	All	—	—	100	—	mV
Settling Time ($V_o < 10\%$ of peak deviation)	All	—	—	2000	—	μs
Load Change from IO2 = 50% to 75% of I_{o2} , max or $I_{o2} = 50\%$ to 25% of I_{o2} , max; $I_{o1} = 30\%$ of I_{o1} , max: Peak Deviation	All	—	—	100	—	mV
Settling Time ($V_o < 10\%$ of peak deviation)	All	—	—	2000	—	μs

Isolation Specifications

Parameter	Min	Typ	Max	Unit
Isolation Capacitance	—	0.2	—	nF
Isolation Resistance	10	—	—	M Ω

General Specifications

Parameter	Min	Typ	Max	Unit
Calculated MTBF ($I_o = 80\%$ of $I_{o, \text{max}}$; $T_A = 20 \text{ }^\circ\text{C}$)				
HW025AF		4,000,000		hours
HW025FG		4,900,000		hours
Weight	—	—	23 (0.81)	g (oz.)

Solder Ball and Cleanliness Requirements

The open frame (no case or potting) power module will meet the solder ball requirements per J-STD-001B. These requirements state that solder balls must neither be loose nor violate the power module minimum electrical spacing.

The cleanliness designator of the open frame power module is C00 (per J specification).

Solder, Cleaning and Drying Considerations

Post solder cleaning is usually the final circuit-board assembly process prior to electrical board testing. The result of inadequate circuit-board cleaning and drying can affect both the reliability of a power module and the testability of the finished circuit-board assembly. For guidance on appropriate soldering, cleaning, and drying procedures, refer to the *Board-Mounted Power Modules Soldering and Cleaning* Application Note (AP97-021EPS).

Feature Specifications

Unless otherwise indicated, specifications apply over all operating input voltage, resistive load, and temperature conditions. See Feature Descriptions for additional information.

Table 3. Feature Specifications

Parameter	Device	Symbol	Min	Typ	Max	Unit
Remote On/Off Signal Interface* ($V_I = 0\text{ V}$ to 75 V ; open collector or equivalent compatible; signal referenced to $V_I(-)$ terminal; see Figure 18. and Feature Descriptions.): HW025 Preferred Negative Logic: Logic Low—Module On Logic High—Module Off HW025 Optional Positive Logic: Logic Low—Module Off Logic High—Module On Logic Low: At $I_{on/off} = 1.0\text{ mA}$ At $V_{on/off} = 0.0\text{ V}$ Logic High: At $I_{on/off} = 0.0\text{ }\mu\text{A}$ Leakage Current Turn-on Time (I_{o1} & $I_{o2} = 2.5\text{ A}$; V_{o1} and V_{o2} within $\pm 1\%$ of steady state; see Figure 7/14.)	—	$V_{on/off}$ $I_{on/off}$	0 —	— —	1.2 1.0	V mA
Output Voltage Adjustment Range (trim), each output:	HW025AF	V_{o1} V_{o2}	76	—	105 105	%V %V
Note: There are restrictions to the combinations of output voltage. See Output Voltage Adjustment Section.	HW025FG	V_{o1} V_{o2}	76 60	—	105 105	%V %V
Output Overvoltage Protection (Note: Only on V_{o1})	HW025AF HW025FG	V_{o1} V_{o1}	5.6 3.5	—	7.0 4.0	V V
Overtemperature Protection	All	T_{ref}	—	120	—	$^{\circ}\text{C}$

* A Minimum OFF Period of 1 sec is recommended.

Characteristic Curves - AF

The following figures provide typical characteristics for the power modules. The figures are identical for both on/off configurations.

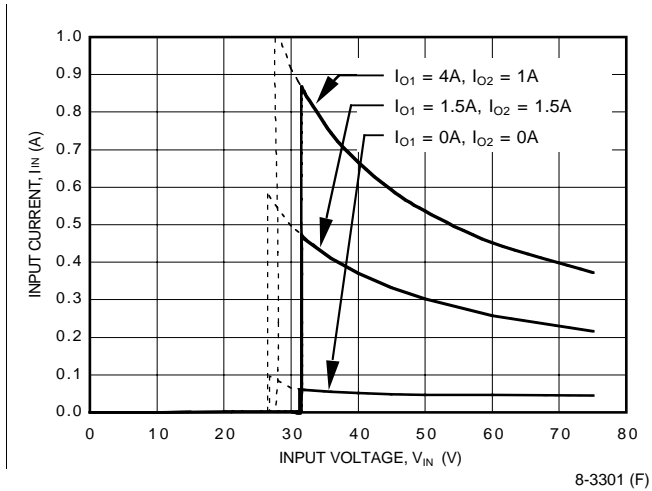

Figure 1. Typical HW025AF Input Characteristics at Room Temperature

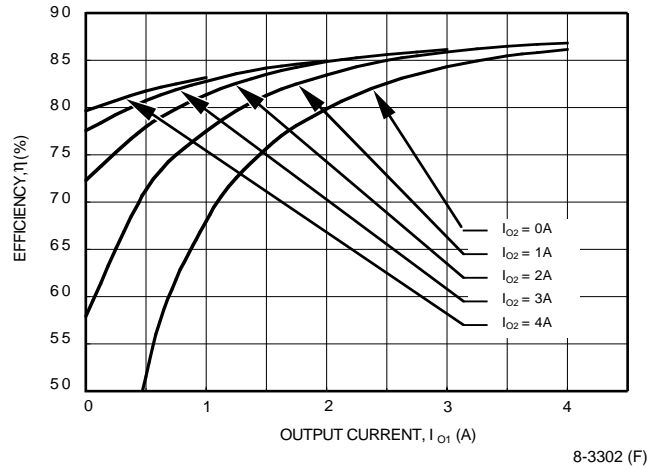

Figure 3. Typical HW025AF Converter Efficiency vs. Output Current at $V_{IN} = 48V$

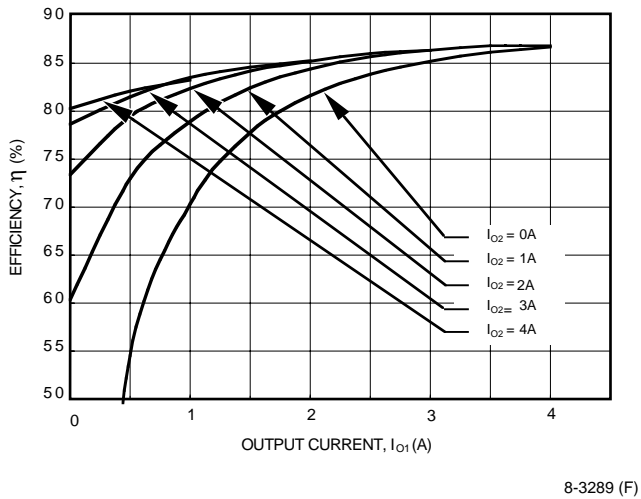

Figure 2. Typical HW025AF Converter Efficiency vs. Output Current at $V_{IN} = 36V$

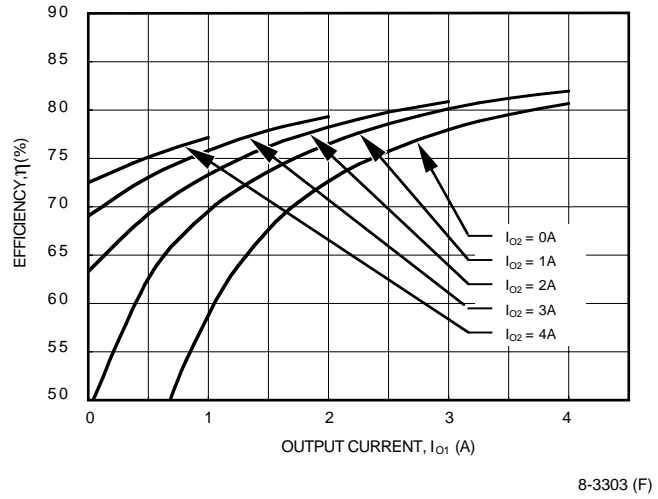
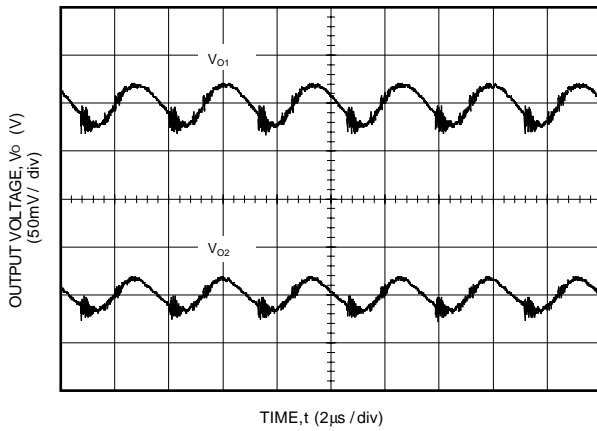

Figure 4. Typical HW025AF Converter Efficiency vs. Output Current at $V_{IN} = 75V$

Characteristic Curves - AF (continued)



8-3304 (F)

Figure 5. Typical HW025AF Output Ripple Voltage at Room Temperature, $V_{IN} = 48V$ and $I_{O1} = I_{O2} = 2.5A$

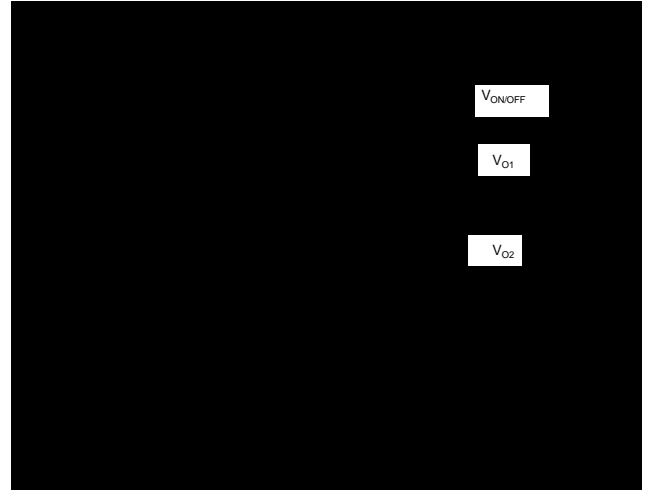

8-3291 (F)

Figure 7. Typical Start-Up from Remote On/Off HW025AF; $I_{O1} = I_{O2} = 2.5A$ and $V_{IN} = 48V$

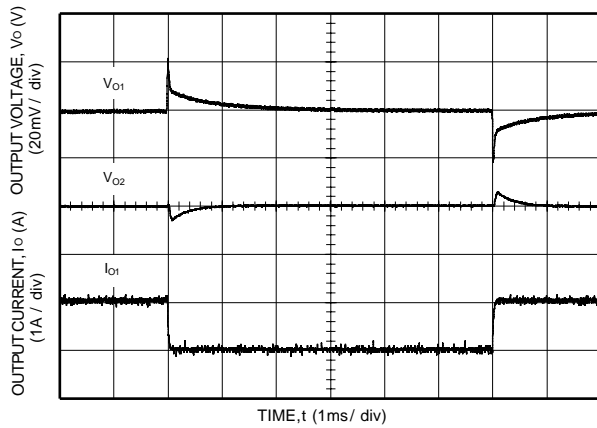

8-3290 (F)

Figure 6. Typical HW025AF Transient response to Step Load Change, $I_{O1} = 50\%$ to 25% to 50% of $I_{O, max}$ ($0.1A / \mu s$) at Room Temperature and 48V Input (Waveform Averaged to Eliminate Ripple Component.)

Characteristic Curves - FG

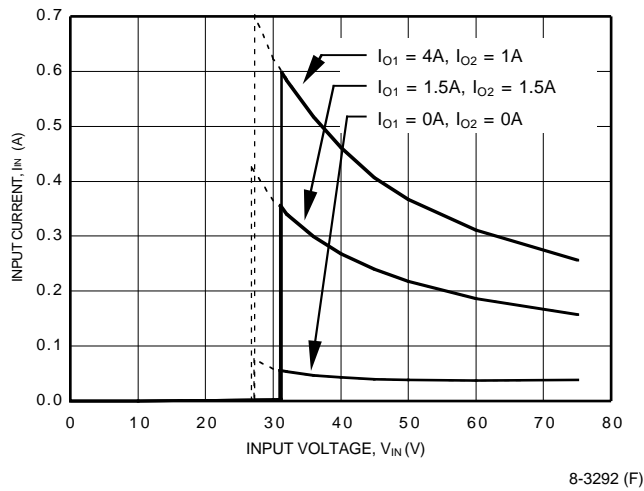

Figure 8. Typical HW025FG Input Characteristics at Room Temperature

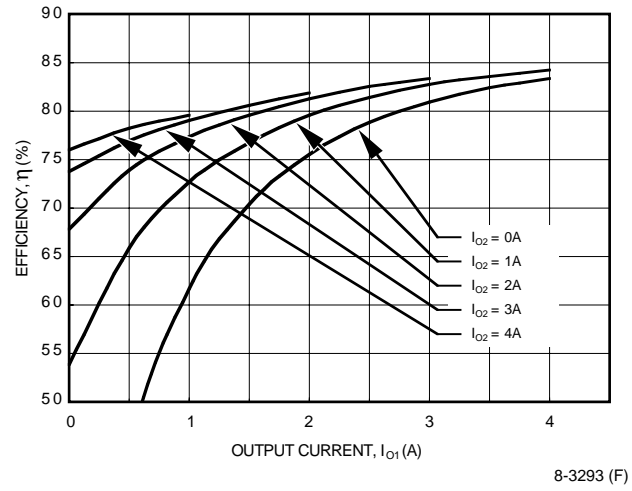

Figure 10. Typical HW025FG Converter Efficiency vs. Output Current at $V_{IN} = 48V$

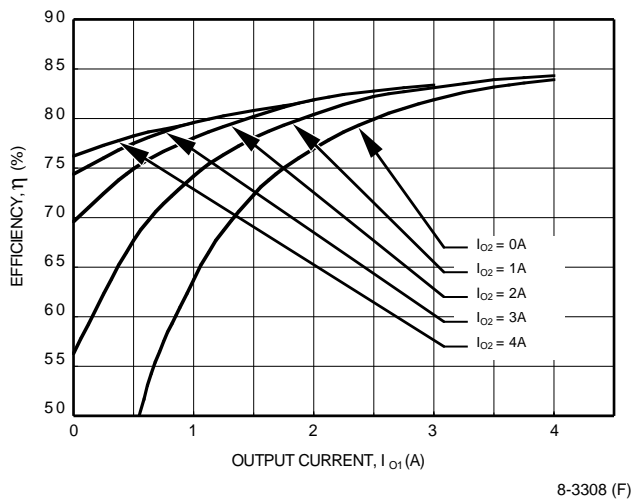

Figure 9. Typical HW025FG Converter Efficiency vs. Output Current at $V_{IN} = 36V$

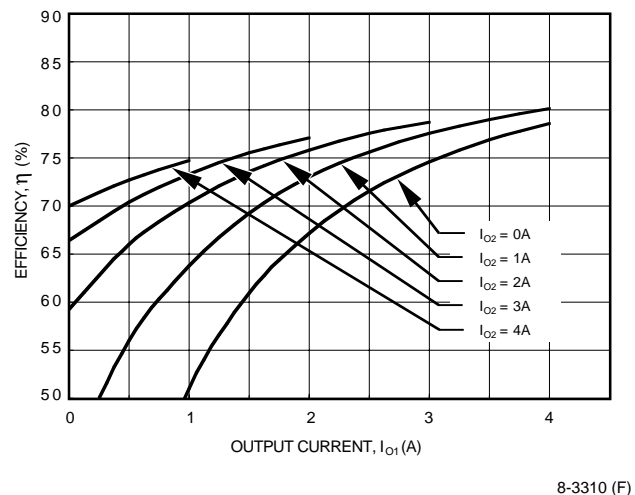
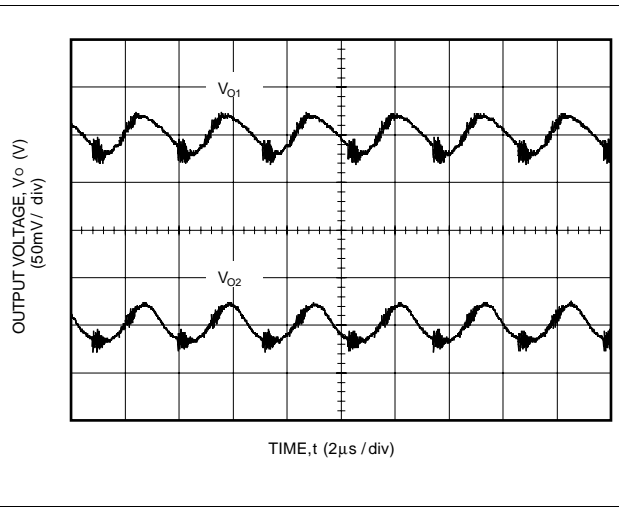

Figure 11. Typical HW025FG Converter Efficiency vs. Output Current at $V_{IN} = 75V$

Characteristic Curves- FG (continued)



8-3311 (F)

Figure 12. Typical HW025FG Output Ripple Voltage at Room Temperature, $V_{IN} = 48V$ and $I_{O1} = I_{O2} = 2.5A$

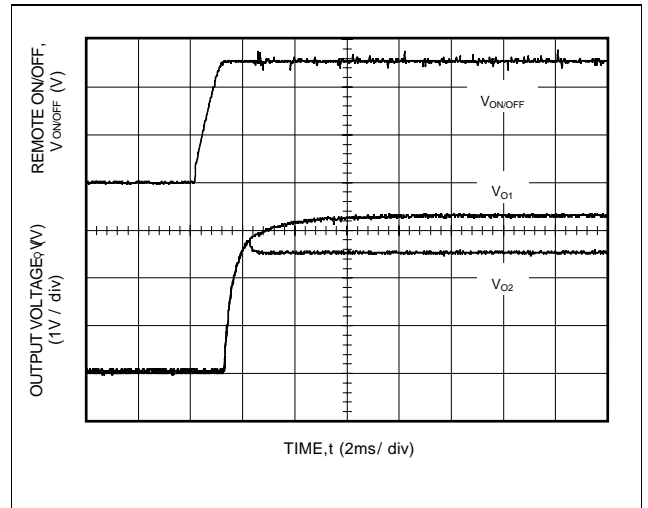

8-3295 (F)

Figure 14. Typical Start-Up from Remote On/Off HW025FG; $I_{O1} = I_{O2} = 2.5A$ and $V_{IN}=48V$

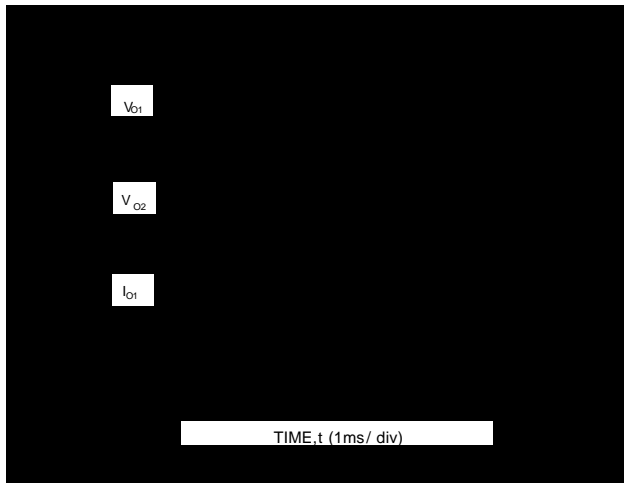

8-3401 (F)

Figure 13. Typical HW025FG Transient response to Step Load Change, $I_{O1} = 50\%$ to 25% to 50% of $I_{O, max}$ ($0.1A / \mu s$) at Room Temperature and $48V$ Input (Waveform Averaged to Eliminate Ripple Component.)

Test Configurations

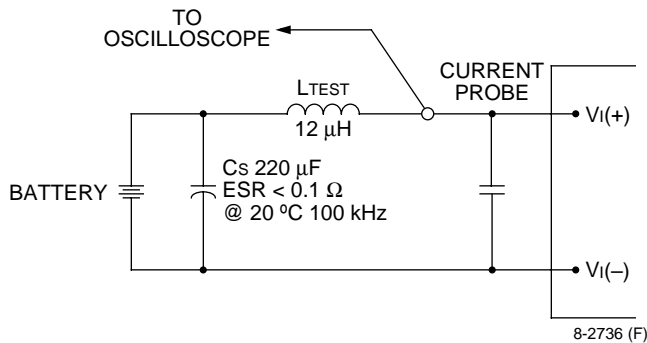

Note: Measure input reflected-ripple current with a simulated source inductance (L_{TEST}) of 12 μH . Capacitor C_s offsets possible battery impedance. Measure current as shown above.

Figure 15. Input Reflected-Ripple Test Setup

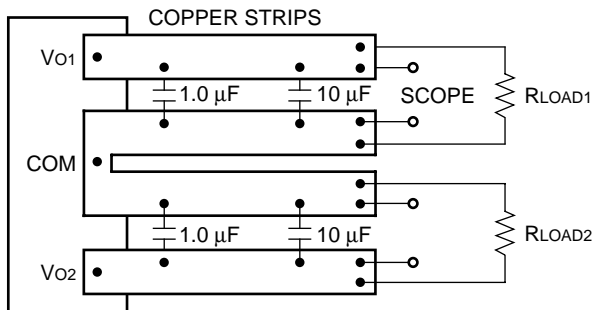

Note: Use a 1.0 μF ceramic capacitor and a 10 μF aluminum or tantalum capacitor. Scope measurement should be made using a BNC socket. Position the load between 51 mm and 76 mm (2 in. and 3 in.) from the module.

Figure 16. Peak-to-Peak Output Noise Measurement Test Setup

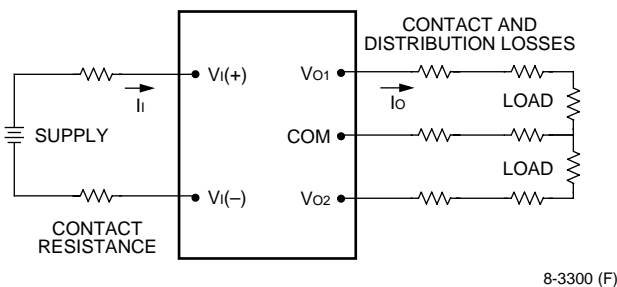

Note: All measurements are taken at the module terminals. When socketing, place Kelvin connections at module terminals to avoid measurement errors due to socket contact resistance.

$$\eta = \frac{\sum_{j=1}^2 | [V_{Oj(+)} - V_{COM}] I_{Oj} |}{[V_i(+)-V_i(-)] I_i} \times 100 \quad \%$$

Figure 17. Output Voltage and Efficiency Measurement Test Setup

Design Considerations

Input Source Impedance

The power module should be connected to a low ac-impedance input source. Highly inductive source impedances can affect the stability of the power module. For the test configuration in Figure 15, a 33 μF electrolytic capacitor (ESR < 0.7 Ω at 100 kHz) mounted close to the power module helps ensure stability of the unit. For other highly inductive source impedances, consult the factory for further application guidelines.

Safety Considerations

For safety-agency approval of the system in which the power module is used, the power module must be installed in compliance with the spacing and separation requirements of the end-use safety agency standard, i.e., UL 60950, CSA C22.2 No. 60950-00, VDE 0805 (EN60950).

If the input source is non-SELV (ELV or a hazardous voltage greater than 60 Vdc and less than or equal to 75Vdc), for the module's output to be considered as meeting the requirements for safety extra-low voltage (SELV), all of the following must be true:

- The input source is to be provided with reinforced insulation from any other hazardous voltages, including the ac mains.
- One V_{IN} pin and one V_{OUT} pin are to be grounded, or both the input and output pins are to be kept floating.
- The input pins of the module are not operator accessible.
- Another SELV reliability test is conducted on the whole system (combination of supply source and subject module), as required by the safety agencies, to verify that under a single fault, hazardous voltages do not appear at the module's output.

Note: Do not ground either of the input pins of the module without grounding one of the output pins. This may allow a non-SELV voltage to appear between the output pins and ground.

The power module has extra-low voltage (ELV) outputs when all inputs are ELV.

The input to these units is to be provided with a maximum 3 A normal-blow fuse in the ungrounded lead.

Feature Descriptions

Overcurrent Protection

To provide protection in a fault (output overload) condition, the unit is equipped with internal current-limiting circuitry and can endure current limiting continuously. At the point of current-limit inception, the unit enters hiccup mode. The unit operates normally once the output current is brought back into its specified range. The average output current during hiccup is 10% $I_{o, max}$.

Remote On/Off

Two remote on/off options are available. Positive logic turns the module on during a logic high voltage on the ON/OFF pin, and off during a logic low. Negative logic turns the module off during a logic high and on during a logic low. Negative logic, device code suffix "1", is the factory-preferred configuration.

To turn the power module on and off, the user must supply a switch (open collector or equivalent) to control the voltage ($V_{on/off}$) between the ON/OFF terminal and the $V_{IN(-)}$ terminal (see Figure 18).

Logic low is $0V \leq V_{on/off} \leq 1.2V$. The maximum $I_{on/off}$ during a logic low is 1mA, the switch should be maintain a logic low level whilst sinking this current.

During a logic high, the maximum $V_{on/off}$ generated by the module is 15V, and the maximum allowable leakage current at $V_{on/off} = 15V$ is 50µA.

If not using the remote on/off feature:

- For negative logic, short the ON/OFF pin to $V_{IN(-)}$.
- For positive logic, leave ON/OFF pin open.

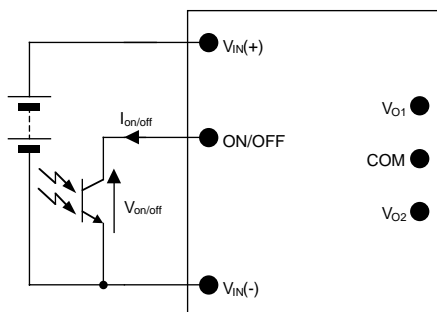

8-2800 (F)

Figure 18. Remote On/Off Implementation

Output Voltage Set-Point Adjustment (Trim)

Trimming allows the output voltage set point to be increased or decreased, this is accomplished by

Lineage Power

connecting an external resistor between the TRIM pin and either the VO(+) pin or the COM pin (see Figure 19).

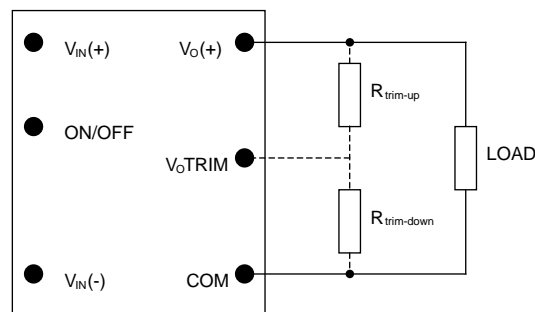

8-2739 (F)

Figure 19. Circuit Configuration to Trim Output Voltage

Connecting an external resistor ($R_{trim-down}$) between the TRIM pin of the desired output and the COM pin decreases the output voltage set point. To maintain set point accuracy, the trim resistor tolerance should be $\pm 0.1\%$.

The relationship between the output voltage and the trim resistor value for a $\Delta\%$ reduction in output voltage is:

$$V_{O1} R_{trim-down} = \left[\frac{511}{\Delta\%} - 6.11 \right] k\Omega$$

$$V_{O2} R_{trim-down} = \left[\frac{100}{\Delta\%} - 1.33 \right] k\Omega$$

See Figures 20 & 21.

Connecting an external resistor ($R_{trim-up}$) between the TRIM pin and the VO(+) pin of the desired output increases the output voltage set point.

For trim-up:

$$V_{O1} R_{trim-up} = \left[\frac{5.11V_{O1}(100+\Delta\%)}{1.225\Delta\%} - \frac{511}{\Delta\%} - 6.11 \right] k\Omega$$

$$V_{O2} R_{trim-up} = \left[\frac{V_{O2}(100+\Delta\%)}{1.225\Delta\%} - \frac{100}{\Delta\%} - 1.33 \right] k\Omega$$

(V_{Ox} refers to the nominal output voltage, i.e. 5.0V for V_{O1} on an AF)

See Figures 22 & 23.

Feature Descriptions (continued)

If not using the trim feature, leave the TRIM pin(s) unconnected.

Note: The following voltage range restrictions apply.

HW025AF

For V_{O1} set to 5.0V – V_{O2} range is 2.5V to 3.3V

HW025FG

For V_{O1} set to 3.3V – V_{O2} range is 1.5V to 2.5V

For V_{O1} set to 2.5V – V_{O2} range is 1.5V to 2.0V

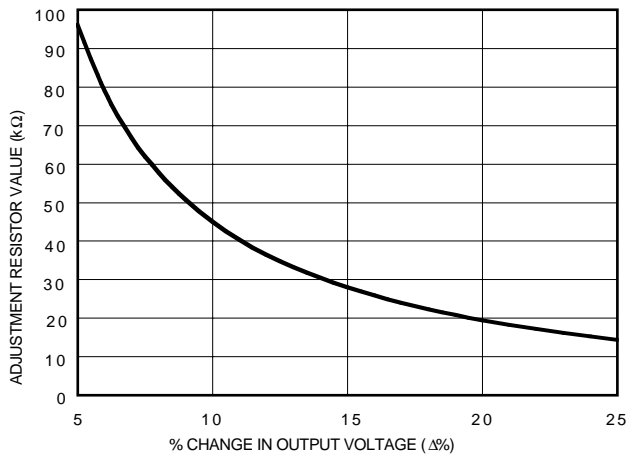

8-2680 (F)

Figure 20. Resistor Selection for Decreased Output Voltage for V_{O1} (AF and FG)

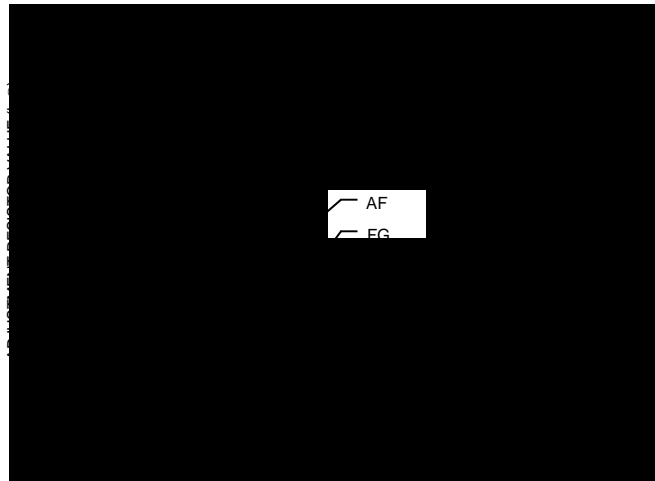

8-3093 (F)

Figure 22. Resistor Selection for Increased Output Voltage on V_{O1}

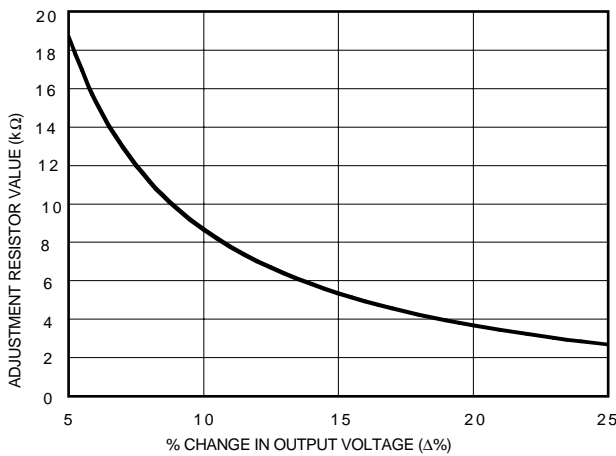

8-2681 (F)

Figure 21. Resistor Selection for Decreased Output Voltage for V_{O2} (AF and FG)

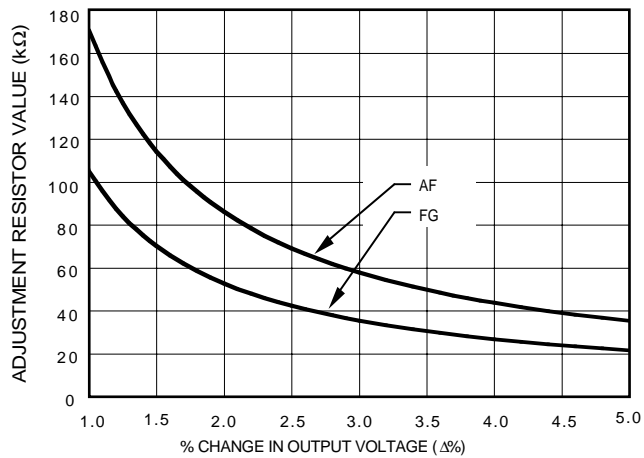

8-3094 (F)

Figure 23. Resistor Selection for Increased Output Voltage on V_{O1}

Feature Descriptions (continued)

Output Overvoltage Protection

The output overvoltage protection consists of circuitry that monitors V_{O1} . If the voltage at the terminals exceeds the overvoltage threshold, then the module will shutdown and attempt to restart.

Thermal Considerations

Heat is removed by convection and radiation to the surrounding environment, sufficient cooling should be provided to ensure reliable operation of the unit. Considerations include ambient temperature, airflow, module power dissipation, and need for increased reliability.

The thermal reference point, T_{ref} , used in the specifications is shown in Figure 24

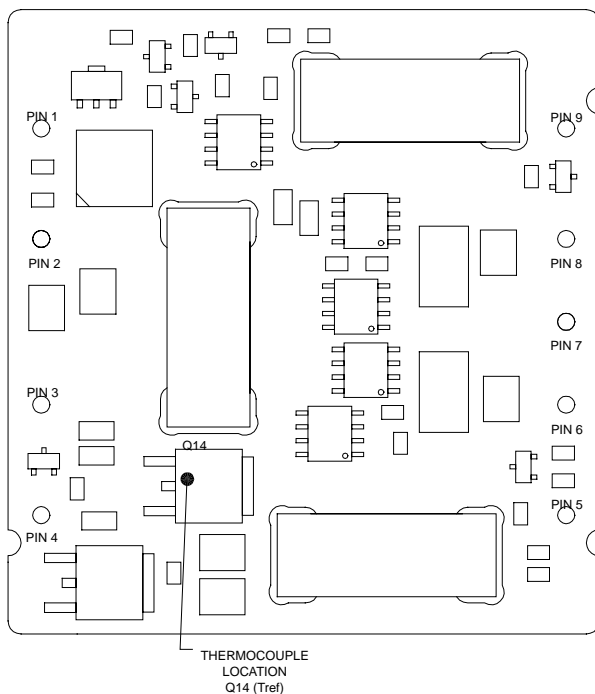

8-3402 (F).a

Figure 24. T_{ref} Temperature Measurement Location

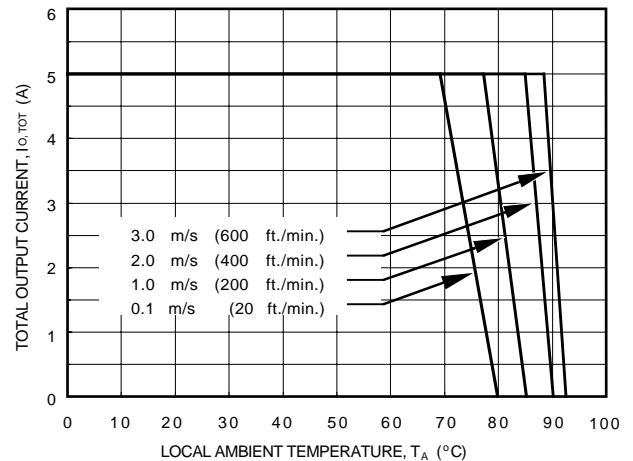

8-3094 (F)

Figure 25. Typical Maximum Total Output Current vs. Local Ambient Temperature

Overtemperature Protection

To provide protection in a fault condition, the unit is equipped with a thermal shutdown circuit. The unit will shutdown if the overtemperature threshold is exceeded it will then wait for the unit to cool before attempting to restart.

EMC Considerations

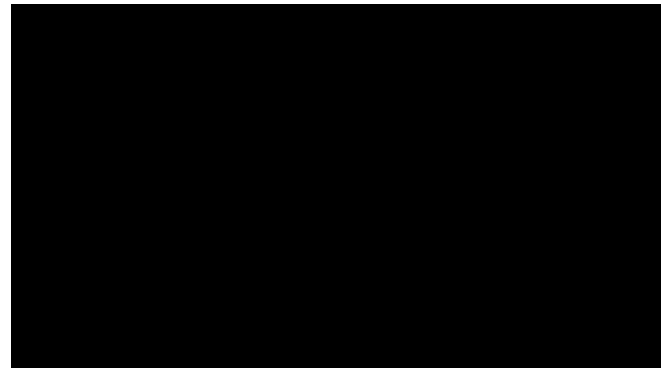

Figure 26. Suggested Configuration for EN55022 Class B

For assistance with designing for EMC compliance, please refer to the FLTR100V10 data sheet (FDS01-043EPS).

Layout Considerations

Copper paths must not be routed beneath the power module mounting inserts. For additional layout guide-lines, refer to FLTR100V10 data sheet (FDS01-043EPS).

Outline Diagram

Dimensions are in millimeters and (inches)
Tolerances: x.x mm ± 0.5 mm (x.xx in. ± 0.02 in.)

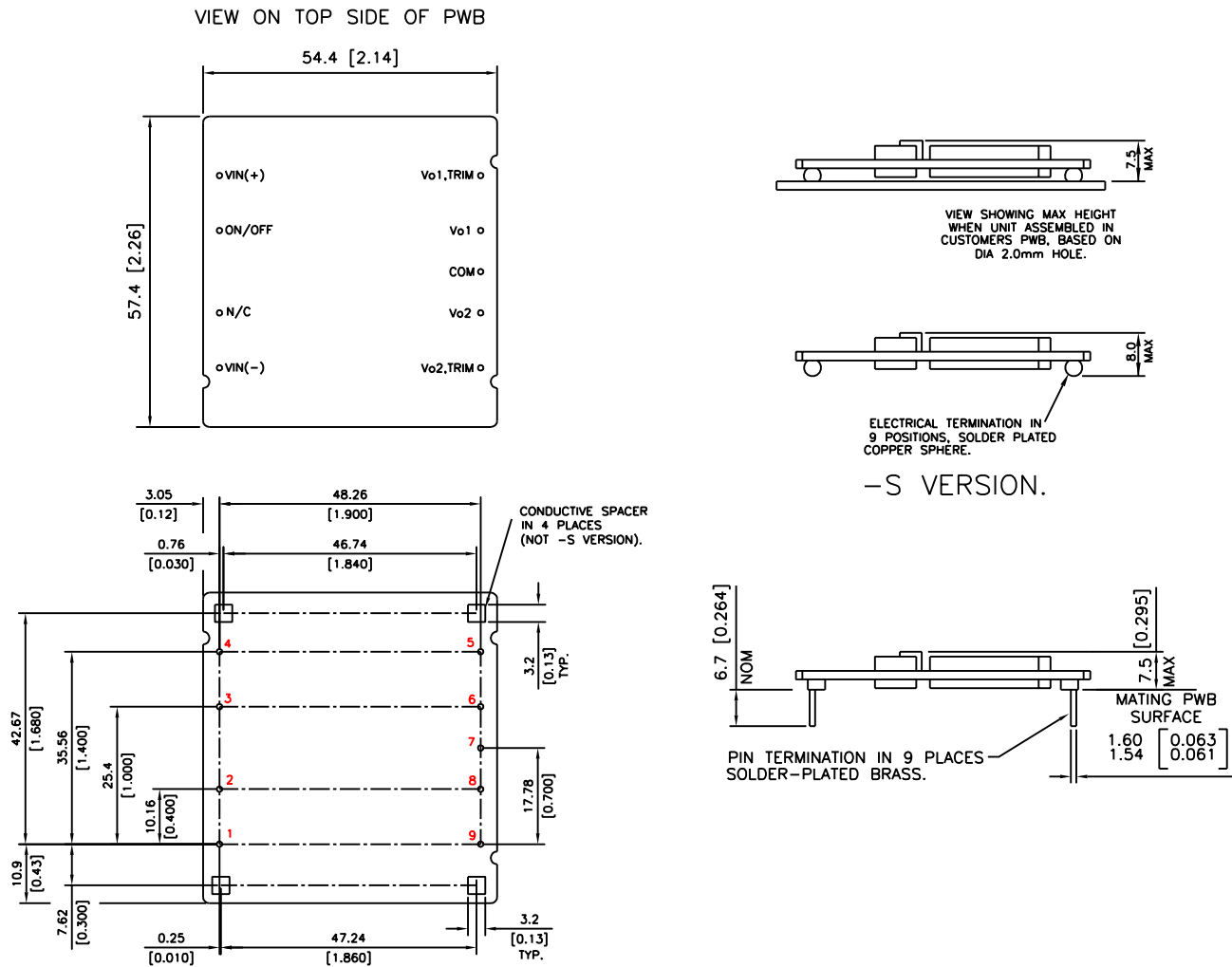

Table 4. Pin Functions

Pin	Function	Pin	Function
1	VI(+)	6	Vo2
2	REMOTE ON/OFF	7	COM
3	Not Connected	8	Vo1
4	VI(-)	9	Vo1TRIM
5	Vo2TRIM		

Ordering Information

For assistance in ordering, please contact your Lineage Power Account Manager or Field Application Engineer for pricing and availability.

Feature Specifications

Input Voltage	Output Voltage	Remote On/Off Logic	Basic Isolation	Surface mount	Device Code	Comcode
48V	5.0V 3.3V	Negative	-	-	HW025AF1	
			✓	-	HW025AF1-B	
			-	✓	HW025AF1-S	
			✓	✓	HW025AF1-BS	
		Positive	-	-	HW025AF	108776774
			✓	-	HW025AF-B	
			-	✓	HW025AF-S	
			✓	✓	HW025AF1-BS	
48V	3.3V 2.5V	Negative	-	-	HW025FG1	
			✓	-	HW025FG1-B	
			-	✓	HW025FG1-S	
			✓	✓	HW025FG1-BS	
		Positive	-	-	HW025FG	108573023
			✓	-	HW025FG-B	
			-	✓	HW025FG-S	108869926
			✓	✓	HW025FG-BS	



World Wide Headquarters

Lineage Power Corporation

3000 Skyline Drive, Mesquite, TX 75149, USA

+1-800-526-7819

(Outside U.S.A.: **+1-972-284-2626**)

www.lineagepower.com

e-mail: techsupport1@lineagepower.com

Asia-Pacific Headquarters

Tel: +65 6416 4283

Europe, Middle-East and Africa Headquarters

Tel: +49 89 6089 286

India Headquarters

Tel: +91 80 28411633

Lineage Power reserves the right to make changes to the product(s) or information contained herein without notice. No liability is assumed as a result of their use or application. No rights under any patent accompany the sale of any such product(s) or information.

© 2008 Lineage Power Corporation, (Mesquite, Texas) All International Rights Reserved.