

DATA SHEET

SKYA21051: 200 to 6000 MHz Broadband Low-Noise Amplifier

Automotive Applications

- In-cabin cellular telematics repeater
- Japan Intelligent Transport Systems 700 MHz Rx LNA: ARIB STD-T109
- FDD and TDD 2G/3G/4G LTE, LTE-A systems
- Active antenna array and MIMO
- Low-noise broadband gain block and driver amplifier

Features

- AEC-Q100 grade-2 qualification pending
- Enhanced ruggedness meeting bHAST/THB qualification requirements
- Level-3 PPAP available on request
- IMDS material declaration supported
- Extended production life to support automotive requirements
- Excellent broadband flat gain performance
- Low noise figure
- High IP3 performance over voltage
- Single matching circuit for 200 to 6000 MHz
- Adjustable supply current from 30 to 100 mA
- Flexible bias voltage: 3 to 5 V
- Fast rise/fall time ENABLE function suitable for TDD application
- Temperature and process-stable active bias up to +105 °C
- Miniature DFN (8-pin, 2 x 2 mm) package (MSL1 @ 260 °C per JEDEC J-STD-020)



Skyworks Green™ products are compliant with all applicable legislation and are halogen-free. For additional information, refer to *Skyworks Definition of Green™*, document number SQ04-0074.

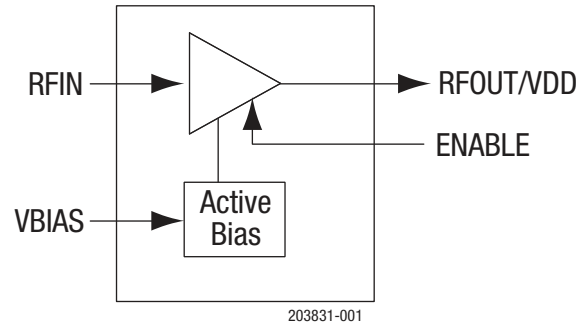

Figure 1. SKYA21051 Block Diagram

Description

The SKYA21051 is an automotive ultra-broadband low-noise amplifier with superior gain flatness and exceptional linearity.

The compact 2 x 2 mm, 8-pin Dual Flat No Lead packaged LNA is designed for FDD and TDD 2G/3G/4G LTE small-cell base stations operating from 200 to 6000 MHz.

The internal active bias circuitry provides stable performance over temperature and process variation. The device offers the ability to externally adjust supply current.

A functional block diagram is shown in Figure 1. The pin configuration and package are shown in Figure 2. Signal pin assignments and functional pin descriptions are provided in Table 1.

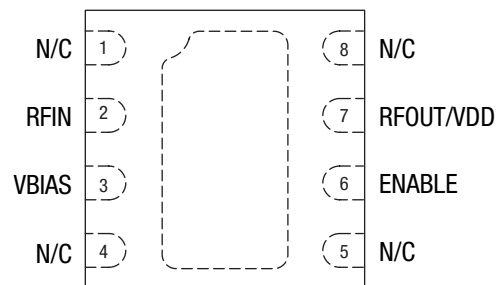

Figure 2. SKYA21051 Pinout (Top View)

Table 1. SKYA21051 Signal Descriptions

Pin	Name	Description	Pin	Name	Description
1	N/C	No connection. May be left open, connected to VDD, or connected to ground with no change in performance.	5	N/C	No connection. May be connected to ground with no change in performance.
2	RFIN	RF input. DC blocking capacitor required.	6	ENABLE	Enable pin. Active low = amplifier ON state.
3	VBIAS	Bias voltage for input gate. External resistor sets current consumption.	7	RFOUT/VDD	RF output. Apply VDD through RF choke inductor. DC blocking capacitor required.
4	N/C	No connection. May be connected to ground with no change in performance.	8	N/C	No connection. May be connected to ground with no change in performance.

Electrical and Mechanical Specifications

The absolute maximum ratings of the SKYA21051 are provided in Table 2. Electrical specifications are provided in Tables 3 through 7.

Typical performance characteristics are illustrated in Figures 3 through 35.

Table 2. SKYA21051 Absolute Maximum Ratings¹

Parameter	Symbol	Minimum	Maximum	Units
Supply voltage	VDD		5.5	V
Quiescent supply current	I _{DD}		100	mA
RF input power (C/W)	P _{IN}		+21	dBm
Storage temperature	T _{STG}	-40	+150	°C
Operating temperature ^{2,3}	T _A	-40	+105	°C
Junction temperature	T _J		+150	°C
Electrostatic discharge:	ESD			
Charged Device Model (CDM), Class 4			1000	V
Human Body Model (HBM), Class 1A			250	V
Machine Model (MM), Class A			30	V

¹ Exposure to maximum rating conditions for extended periods may reduce device reliability. There is no damage to device with only one parameter set at the limit and all other parameters set at or below their nominal value. Exceeding any of the limits listed here may result in permanent damage to the device.

² In all cases, ambient operating temperature (T_A) is specified relative to case temperature (T_C) and assumes T_A = (T_C - 10 °C).

³ Case operating temperature (T_C) refers to the temperature at the ground pad on the underside of the package.

ESD HANDLING: *Although this device is designed to be as robust as possible, electrostatic discharge (ESD) can damage this device. This device must be protected at all times from ESD when handling or transporting. Static charges may easily produce potentials of several kilovolts on the human body or equipment, which can discharge without detection. Industry-standard ESD handling precautions should be used at all times.*

Table 3. SKYA21051 Electrical Specifications: Thermal Data¹

(V_{DD} = 3.3 V, Enable = GND, T_A = +25 °C, P_{IN} = -20 dBm, Characteristic Impedance [Z₀] = 50 Ω, Unless Otherwise Noted)

Parameter	Symbol	Test Condition	Min	Typ	Max	Units
Thermal resistance	θ _{JC}			40		°C/W
Channel temperature @ +85 °C reference (package heat slug)		V _{DD} = 3.3 V, I _{CO} = 16 mA, no RF applied, dissipated power = 53 mW		87.1		°C

¹ Performance is guaranteed only under the conditions listed in this table.

Table 4. SKYA21051 Electrical Specifications: 760 MHz Optimized Tuning¹ (See Figure 38)

(V_{DD} = 3.3 V, Enable = GND, T_A = +25 °C, P_{IN} = -20 dBm, R_{BIAS} = 15 kΩ, Characteristic Impedance [Z₀] = 50 Ω, Unless Otherwise Noted)

Parameter	Symbol	Test Condition	Min	Typ	Max	Units
RF Specifications						
Noise figure ²	NF	Small signal		1	1.5	dB
Small signal gain	IS21I	P _{IN} = -20 dBm	14	15.5		dB
Input return loss	IS11I	P _{IN} = -20 dBm	8.5	10		dB
Output return loss	IS22I	P _{IN} = -20 dBm	13	20		dB
Reverse isolation	IS12I	P _{IN} = -20 dBm		22		dB
Third order input intercept point	IIP3	@ 760 MHz (tone spacing 1 MHz)	+1	+2		dBm
Third order output intercept point	OIP3	@ 760 MHz (tone spacing 1 MHz)	+12	+17		dBm
1 dB input compression point	IP1dB	@ 760 MHz	-8	-6.1		dBm
1 dB output compression point	OP1dB	@ 760 MHz	+6	+8.9		dBm
DC Specifications						
Supply voltage	V _{DD}			3.3		V
Quiescent current	I _{DD}	Set with external resistor (R _{BIAS} = 15 kΩ)	10	13	16	mA
Bias current	I _{BIAS}			200		μA
Enable voltage:	V _{EN}		0		0.2	V
Gain mode			1.1		5.5	V
Power-down mode						
Enable rise time ³	t _{ON}				500	ns
Enable fall time ³	t _{OFF}				150	ns

¹ Performance is guaranteed only under the conditions listed in this table.

² Connector and board loss are de-embedded.

³ Tested with a 100 kHz square wave, 1000 pF capacitance-to-ground on the ENABLE pin. Switching time can be improved by reducing the value of, or eliminating, the 1000 pF capacitor on pin 6 (component M17 in Figure 11).

Table 5. SKYA21051 Electrical Specifications: 700 to 2700 MHz Optimized Tuning¹
(V_{DD} = 3.3 V, Enable = GND, T_A = +25 °C, P_{IN} = -20 dBm, Characteristic Impedance [Z₀] = 50 Ω, Unless Otherwise Noted)

Parameter	Symbol	Test Condition	Min	Typical	Max	Units
RF Specifications						
Noise figure ²	NF	@ 700 MHz		0.95		dB
		@ 1200 MHz		0.97		dB
		@ 2100 MHz		0.98		dB
		@ 2700 MHz		1		dB
Small signal gain	S ₂₁	@ 700 MHz		17.8		dB
		@ 1200 MHz		17.5		dB
		@ 2100 MHz		17.3		dB
		@ 2700 MHz		17.1		dB
Input return loss	S ₁₁	@ 700 MHz		18		dB
		@ 1200 MHz		20		dB
		@ 2100 MHz		20		dB
		@ 2700 MHz		18		dB
Output return loss	S ₂₂	@ 700 MHz		22		dB
		@ 1200 MHz		19		dB
		@ 2100 MHz		19		dB
		@ 2700 MHz		22		dB
Reverse isolation	S ₁₂	@ 700 MHz		22		dB
		@ 1200 MHz		22		dB
		@ 2100 MHz		22		dB
		@ 2700 MHz		23		dB
Third order input intercept point	IIP3	@ 700 MHz, Δf = 1 MHz, P _{IN} = -20 dBm/tone	12	14.2		dBm
		@ 2700 MHz, Δf = 1 MHz, P _{IN} = -20 dBm/tone	10	12.4		dBm
Third order output intercept point	OIP3	@ 700 MHz, Δf = 1 MHz, P _{IN} = -20 dBm/tone	30	32		dBm
		@ 2700 MHz, Δf = 1 MHz, P _{IN} = -20 dBm/tone	27.5	29.5		dBm
1 dB input compression point	IP1dB	@ 700 MHz	-1	+1		dBm
		@ 2700 MHz	-2	0		dBm
1 dB output compression point	OP1dB	@ 700 MHz	+16	+18		dBm
		@ 2700 MHz	+14	+16		dBm
DC Specifications						
Supply voltage	V _{DD}			3.3		V
Quiescent current	I _{DD}	Set with external resistor (R _{BIAS} = 4.7 kΩ)		45		mA
Bias current	I _{BIAS}					μA
Enable voltage: Gain mode Power-down mode	V _{EN}		0		0.2	V
			1.5		5.5	V
Enable rise time ³	t _{ON}	@ 2700 MHz		400		ns
Enable fall time ³	t _{OFF}	@ 2700 MHz		150		ns

¹ Verified by characterization.

² Connector and board loss are de-embedded.

³ Tested with a 100 kHz square wave, 1000 pF capacitance-to-ground on the ENABLE pin. Switching time can be improved by reducing the value of, or eliminating, the 1000 pF capacitor on pin 6 (component M17 in Figure 19).

Table 6. SKYA21051 Electrical Specifications: 3400 to 3800 MHz Optimized Tuning¹
(VDD = +3.3 V, ENABLE = LOW, ICQ = 45 mA, TOP = +25 °C, PIN = -20 dBm, Optimized for 3400 to 3800 MHz Operation, Unless Otherwise Noted)

Parameter	Symbol	Test Condition	Min	Typical	Max	Units
RF Specifications						
Noise figure	NF	@ 3400 MHz @ 3600 MHz @ 3800 MHz		1.2 1.25 1.3		dB dB dB
Small signal gain	IS21I	@ 3400 MHz @ 3600 MHz @ 3800 MHz		16.8 16.7 16.5		dB dB dB
Input return loss	IS11I	@ 3400 MHz @ 3600 MHz @ 3800 MHz		24 30 30		dB dB dB
Output return loss	IS22I	@ 3400 MHz @ 3600 MHz @ 3800 MHz		22 21 22		dB dB dB
Reverse isolation	IS12I	@ 3400 MHz @ 3600 MHz @ 3800 MHz		23 23 23		dB dB dB
Third order input intercept point	IIP3	@ 3400 MHz, Δf = 1 MHz, PIN = -20 dBm/tone	9	11.4		dBm
		@ 3800 MHz, Δf = 1 MHz, PIN = -20 dBm/tone	8	10.9		dBm
Third order output intercept point	OIP3	@ 3400 MHz, Δf = 1 MHz, PIN = -20 dBm/tone	25	28.2		dBm
		@ 3800 MHz, Δf = 1 MHz, PIN = -20 dBm/tone	24	27.4		dBm
1 dB input compression point	IP1dB	@ 3400 MHz	-3	-1		dBm
		@ 3800 MHz	-3	-1		dBm
1 dB output compression point	OP1dB	@ 3400 MHz	12	14.8		dBm
		@ 3800 MHz	12	14.5		dBm

¹ Verified by characterization.

Table 7. SKYA21051 Electrical Specifications: 5G Driver Optimized Tuning¹
(VDD = +5 V, ENABLE = LOW, ICQ = 45 mA, TOP = +25 °C, PIN = -20 dBm, Optimized for 3400 to 5000 MHz Operation, Unless Otherwise Noted)

Parameter	Symbol	Test Condition	Min	Typ	Max	Units
Noise figure	NF	4400 MHz		1.4		dB
Small signal gain	S21	4400 MHz		14.5		dB
Input return loss	S11	4400 MHz		-15		dB
Output return loss	S22	4400 MHz		-15		dB
Isolation	S12	4400 MHz		-25		dB
Third order output intercept point	OIP3	4400 MHz		19		dBm
1 dB output compression point	OP1dB	4400 MHz		16		dBm

¹ Verified by characterization.

Typical Performance Characteristics, 700 to 2700 MHz

(VDD = 3.3 V, Enable = GND, ICQ = 45 mA, TA = +25 °C, PIN = -20 dBm, Characteristic Impedance [Zo] = 50 Ω, Unless Otherwise Noted)

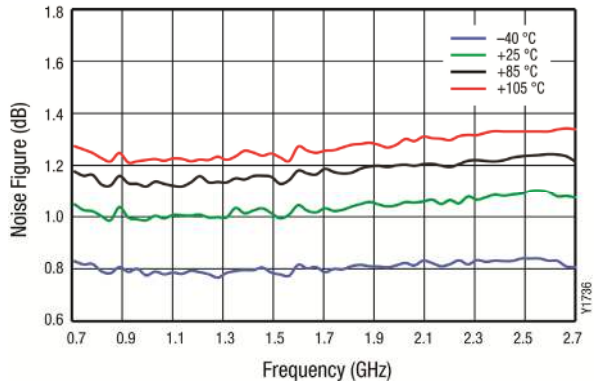

Figure 3. Evaluation Board NF vs Frequency over Temperature

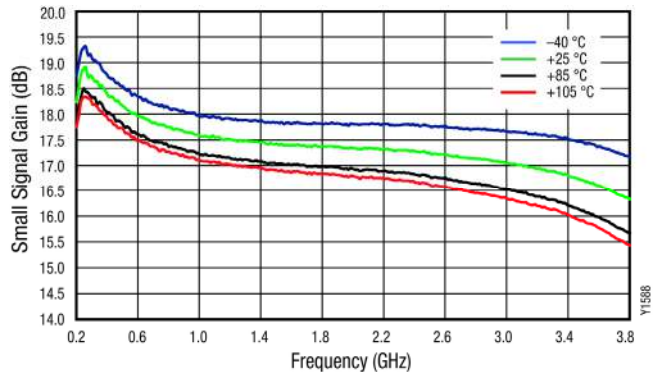

Figure 4. Narrow Band Gain vs Frequency over Temperature

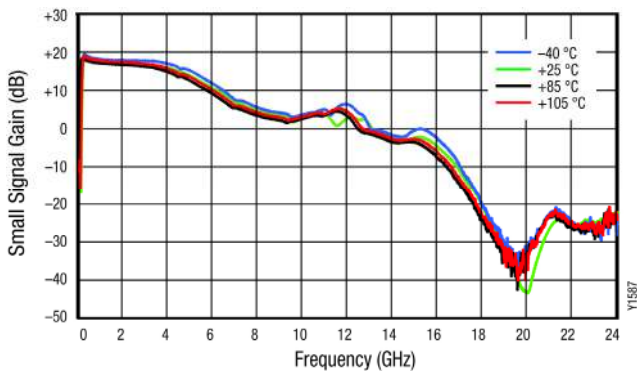

Figure 5. Broadband Gain vs Frequency over Temperature

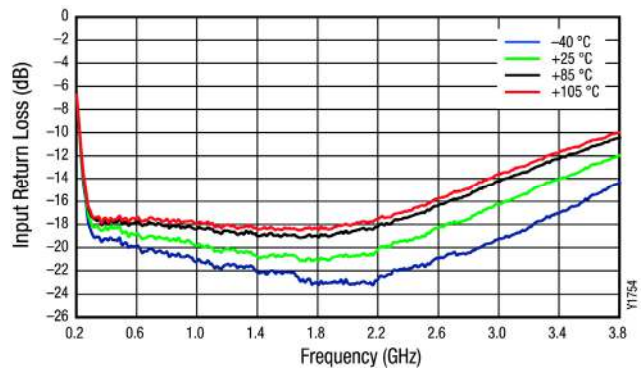

Figure 6. Narrowband Input Return Loss vs Frequency over Temperature

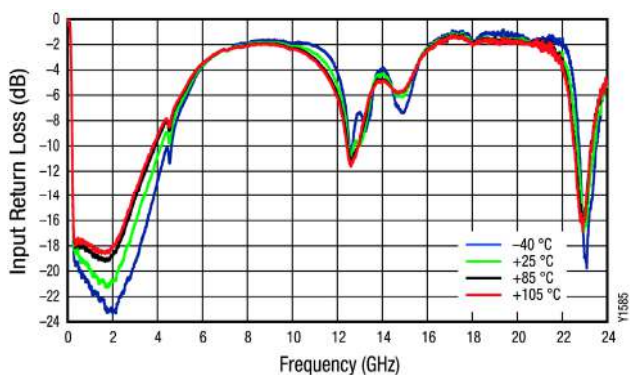

Figure 7. Broadband Input Return Loss vs Frequency over Temperature

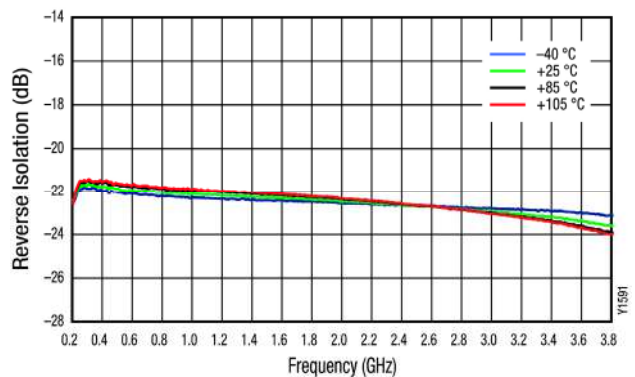

Figure 8. Narrowband Reverse Isolation vs Frequency over Temperature

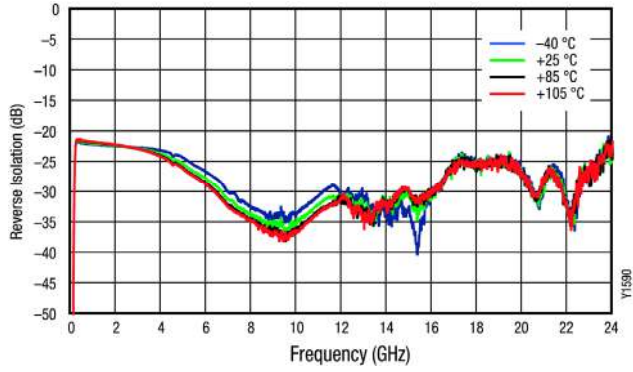

Figure 9. Broadband Reverse Isolation vs Frequency over Temperature

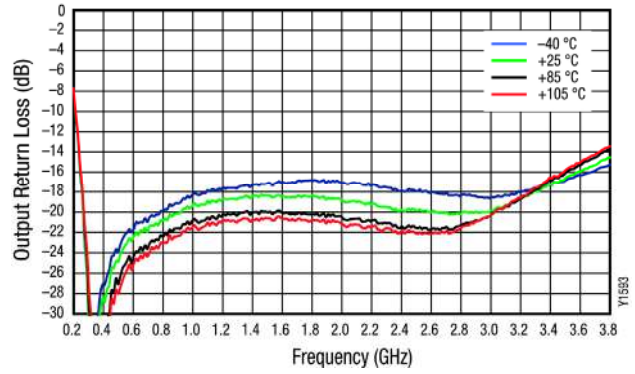

Figure 10. Narrowband Output Return Loss vs Frequency over Temperature

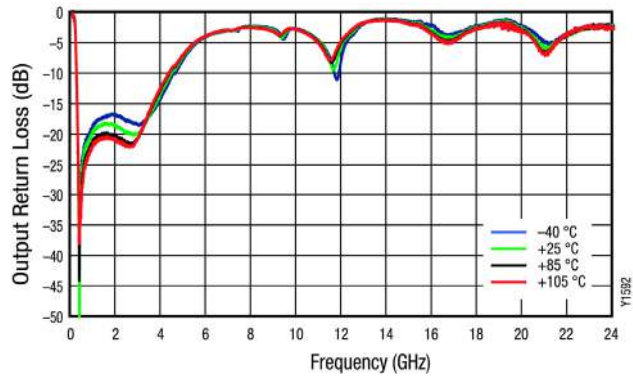

Figure 11. Broadband Output Return Loss vs Frequency over Temperature

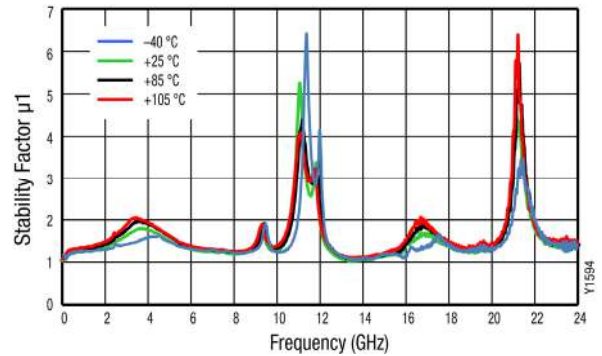

Figure 12. Stability Factor (μ_1) vs Frequency over Temperature

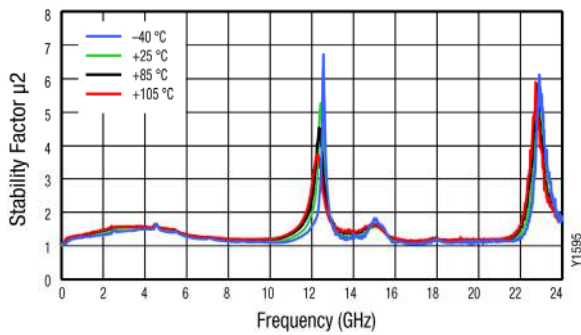

Figure 13. Stability Factor (μ_2) vs Frequency over Temperature

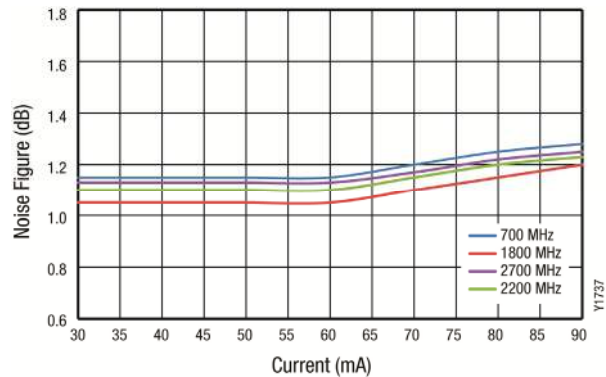

Figure 14. Evaluation Board Noise Figure vs Quiescent Current over Frequency

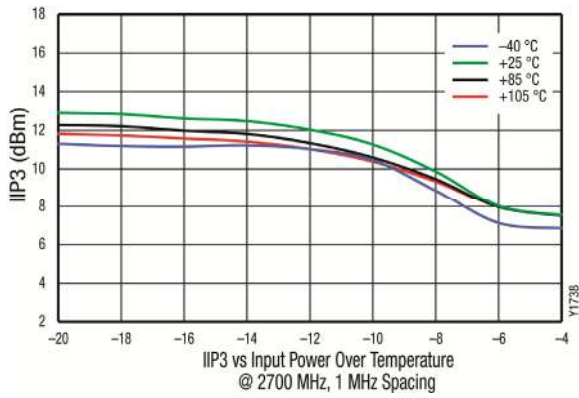

Figure 15. OIP3 vs Input Power over Temperature (@ 2700 MHz, 1 MHz Spacing)

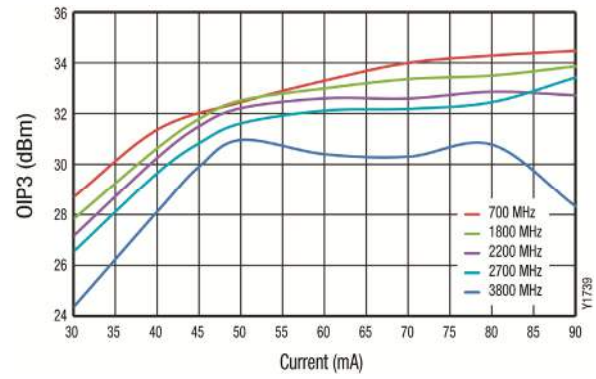

Figure 16. OIP3 vs Quiescent Current over Frequency

Typical Performance Characteristics, 3400 to 3800 MHz Optimized Tuning

(V_{DD} = 3.3 V, Enable = GND, I_{CQ} = 45 mA, T_A = +25 °C, P_{IN} = -20 dBm, Characteristic Impedance [Z₀] = 50 Ω, Unless Otherwise Noted)

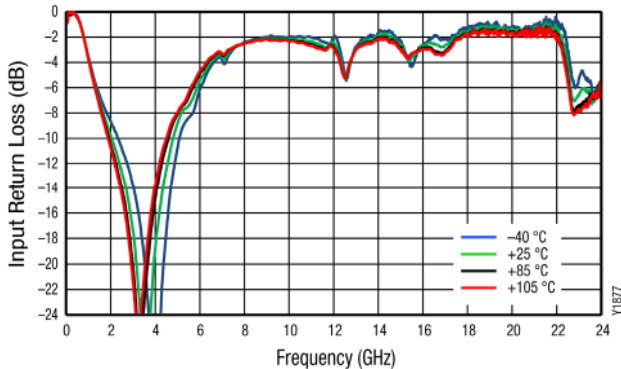

Figure 17. Broadband Input Return Loss vs Frequency over Temperature

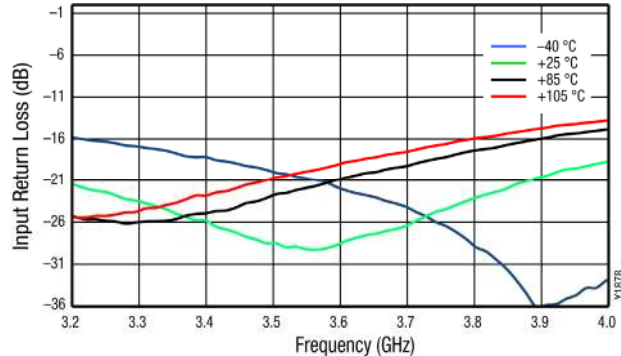

Figure 18. Narrowband Input Return Loss vs Frequency over Temperature

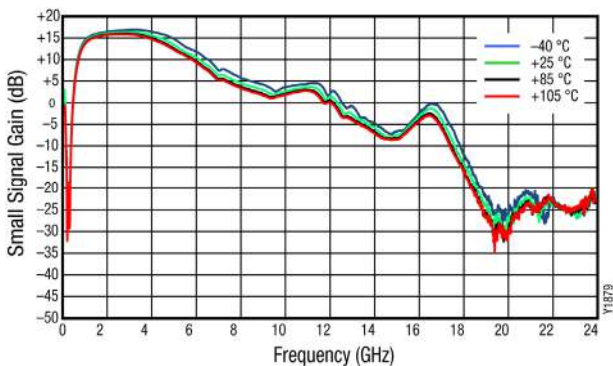

Figure 19. Broadband Gain vs Frequency over Temperature

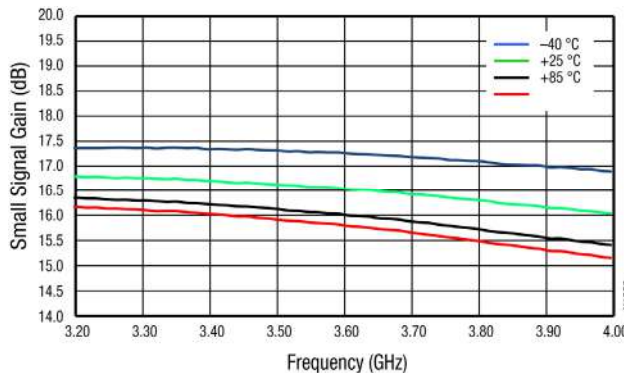

Figure 20. Narrow Band Gain vs Frequency over Temperature

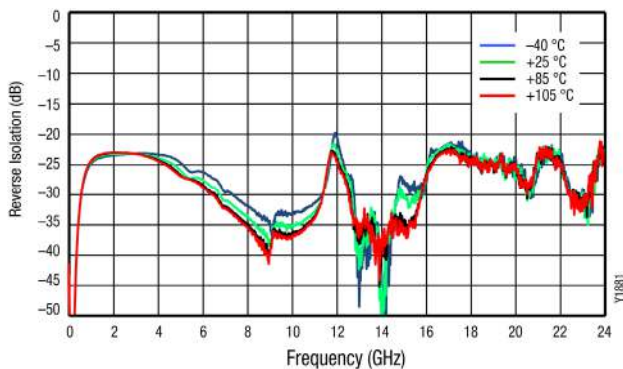

Figure 21. Broadband Reverse Isolation vs Frequency over Temperature

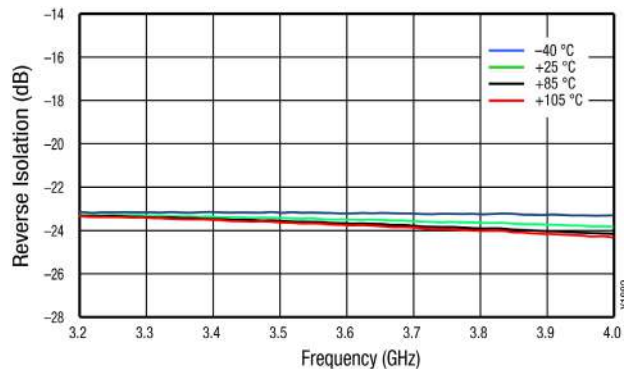

Figure 22. Narrowband Reverse Isolation vs Frequency over Temperature

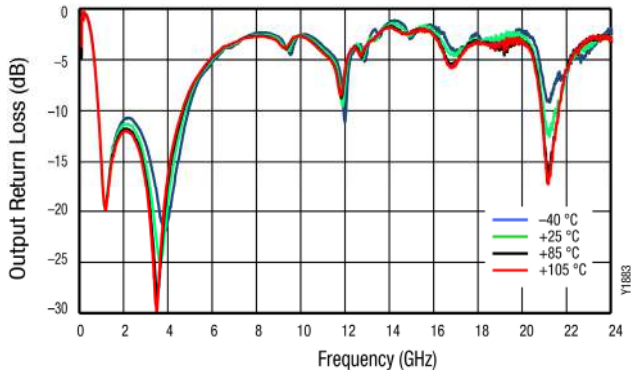

Figure 23. Broadband Output Return Loss vs Frequency over Temperature

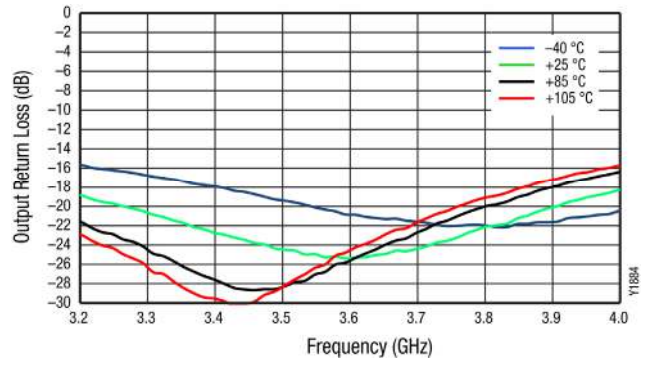

Figure 24. Narrowband Output Return Loss vs Frequency over Temperature

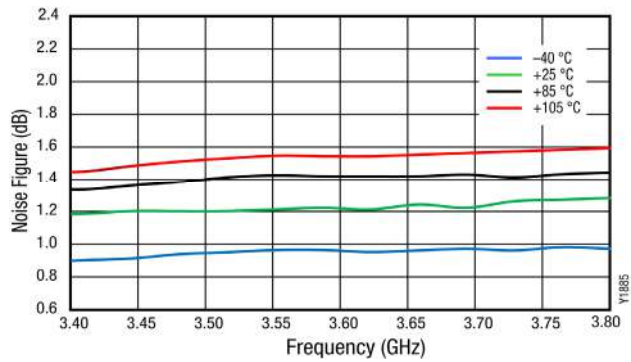

Figure 25. Noise Figure vs Frequency

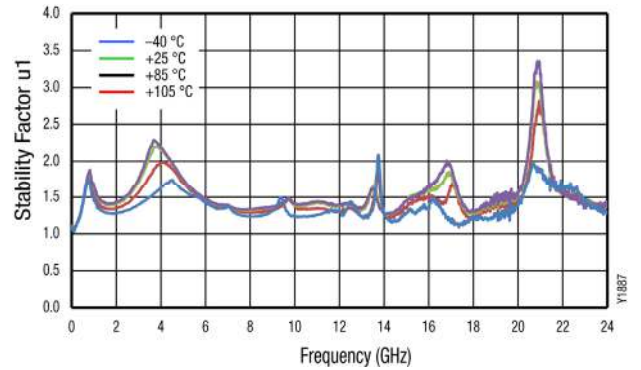

Figure 26. Stability Factor u1 vs Frequency

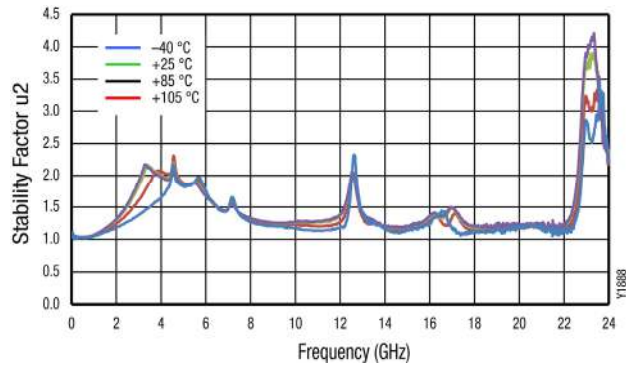

Figure 27. Stability Factor u2 vs Frequency

Typical Performance Characteristics, 5G Driver Optimized Tuning

(VDD = 5 V, Enable = Low, ICQ = 45 mA, TA = +25 °C, PIN = -20 dBm, Optimized for 3400 to 5000 MHz, Unless Otherwise Noted)

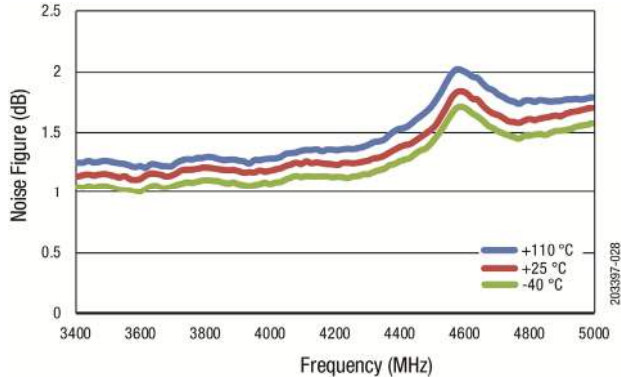

Figure 28. Evaluation Board NF vs Frequency over Temperature

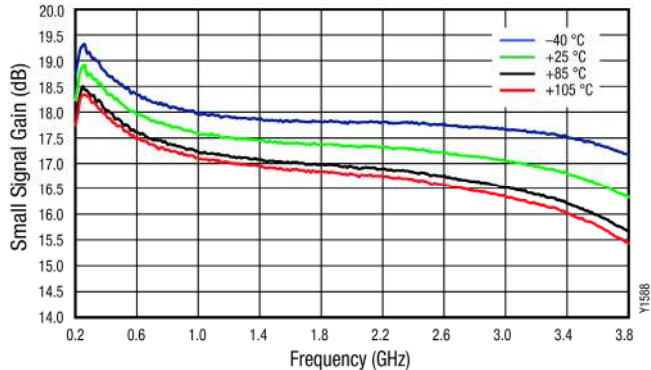

Figure 29. Gain vs Frequency over Temperature

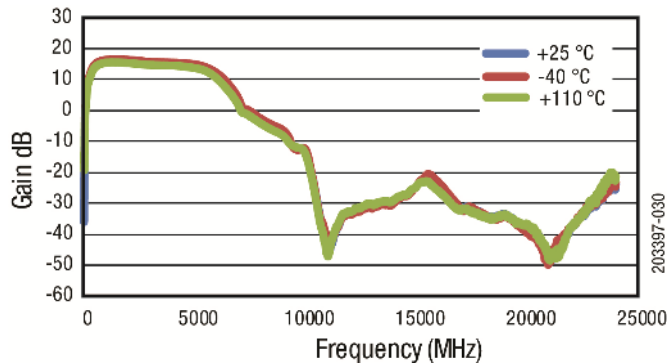

Figure 30. Gain vs Frequency over Temperature

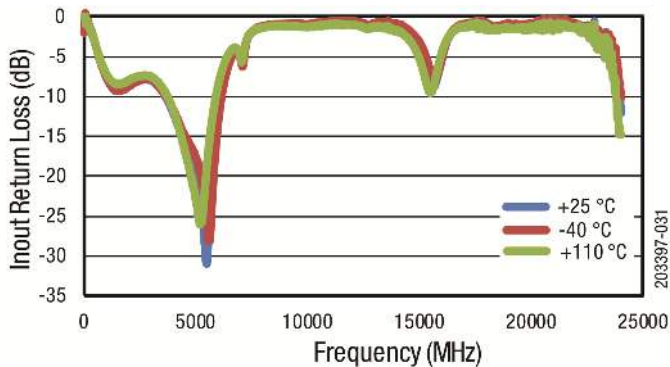

Figure 31. Input Return Loss vs Frequency over Temperature

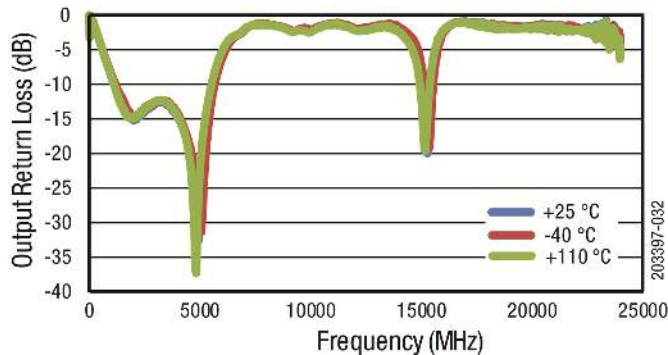

Figure 32. Output Return Loss vs Frequency over Temperature

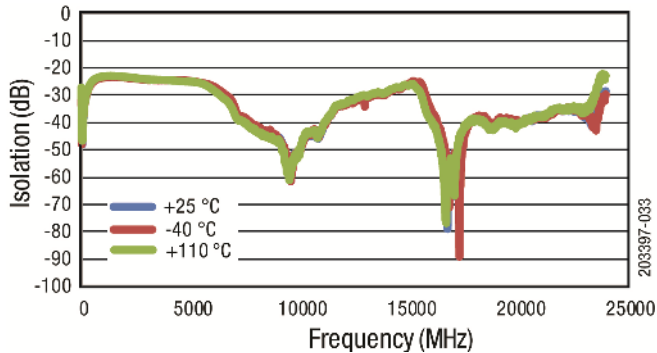

Figure 33. Isolation vs Frequency over Temperature

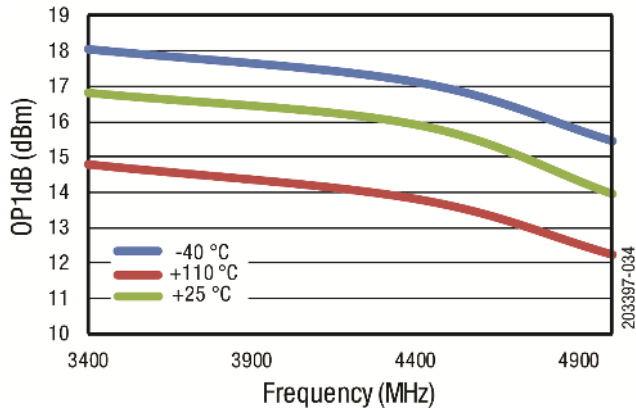

Figure 34. OP1dB vs Frequency over Temperature

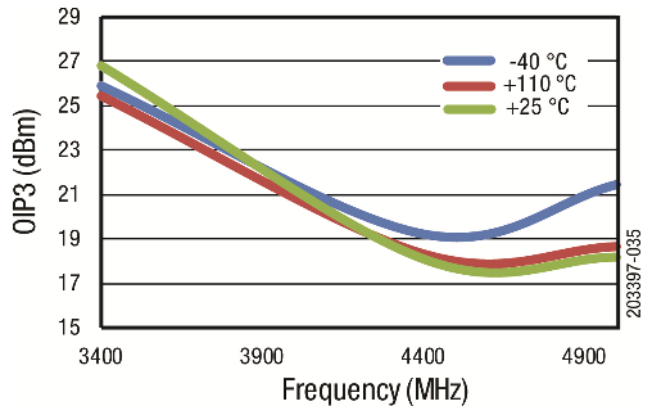

Figure 35. OIP3 vs Frequency over Temperature

Evaluation Board Description

The SKYA21051 Evaluation Board is used to test the performance of the SKYA21051 LNA.

An assembly drawing for the Evaluation Board is shown in Figure 36. The layer detail is provided in Figure 37. An Evaluation Board schematic (optimized for 760 MHz) diagram is provided in Figure 38. Table 8 provides the Bill of Materials (BOM) list for the optimized frequency band (760 MHz). An Evaluation Board schematic (optimized for 700 to 2700 MHz) diagram is provided in Figure 39. Table 9 provides the Bill of Materials (BOM) list for the optimized frequency band (700 to 2700 MHz). Table 10 provides the Bill of Materials (BOM) list for the optimized frequency band (3400 to 5000 MHz). An Evaluation Board schematic (optimized for 3400 to 3800 MHz) diagram is provided in Figure 40. Table 11 provides the Bill of Materials (BOM) list for the optimized frequency band (3400 to 3800 MHz).

Package Dimensions

The PCB layout footprint for the SKYA21051 is provided in Figure 41. Package dimensions are shown in Figure 42, and tape and reel dimensions are provided in Figure 43.

Package and Handling Information

Instructions on the shipping container label regarding exposure to moisture after the container seal is broken must be followed. Otherwise, problems related to moisture absorption may occur when the part is subjected to high temperature during solder assembly.

The SKYA21051 is rated to Moisture Sensitivity Level 1 (MSL1) at 260 °C. It can be used for lead or lead-free soldering. For additional information, refer to the Skyworks Application Note, *Solder Reflow Information*, document number 200164.

Care must be taken when attaching this product, whether it is done manually or in a production solder reflow environment. Production quantities of this product are shipped in a standard tape and reel format.

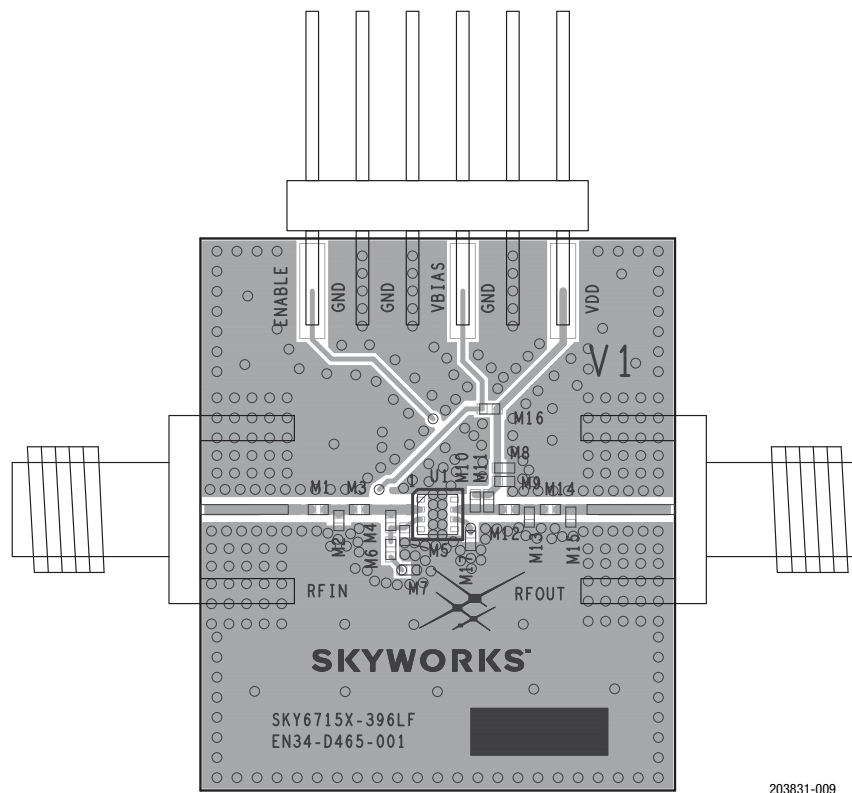

Figure 36. SKYA21051 Evaluation Board Assembly Diagram

Cross Section	Name	Thickness (mm)	Material
	MSK-NS		
	TRA-NS	0.03556	Cu foil
	Laminate	0.254 ± 0.152	Rogers 4350B
	TRA-2	0.0178	Cu foil
	Laminate	0.889 nom.	FR4 Prepreg (Note 1)
	TRA-3	0.0178	Cu foil
	Laminate	0.254 ± 0.152	FR4 Core
	TRA-FS	0.0178	Cu foil
	MSK-PS		

Note 1: Adjust this thickness to meet total thickness goal.

General Notes:

- Material: Rogers R04350, $\epsilon_r = 3.66$
- Layer 1 thickness: 0.254 mm
- Overall board thickness: 1.575 mm
- 50 Ω transmission line width: 0.522 mm
- Coplanar ground spacing: 0.394 mm
- Via diameter: 0.254 mm

203831-0010

Figure 37. Layer Detail Physical Characteristics

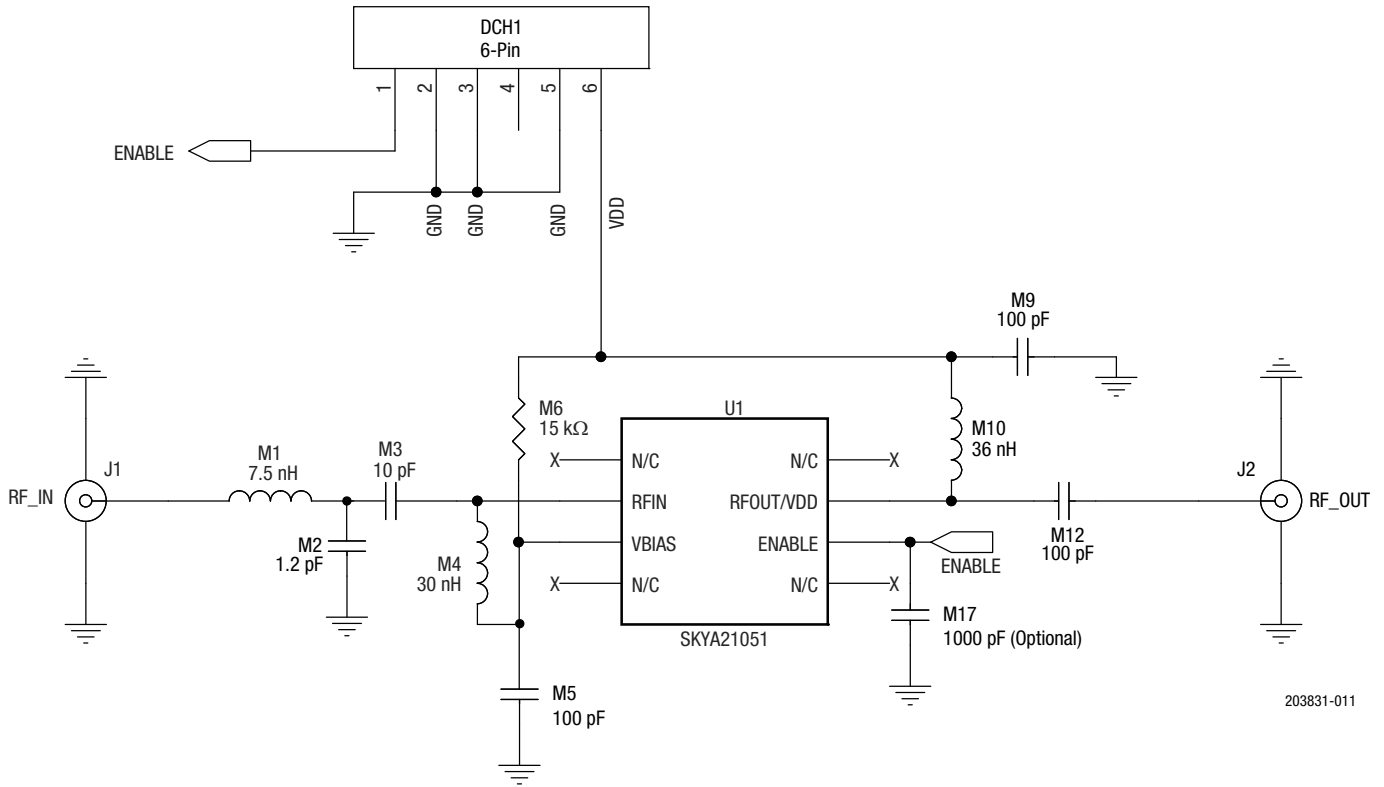

Figure 38. SKYA21051 Evaluation Board Schematic (Optimized for 760 MHz)

Table 8. SKYA21051 Evaluation Board Bill of Materials (760 MHz)

Component	Description	Value	Size	Manufacturer	Mfr Part Number
M1	Inductor	7.5 nH	0402	muRata LQP	CQP15MN7N5B02
M2	Capacitor	1.2 pF	0402	muRata GJM	GJM1555C1H1R2BB01
M3	Capacitor	10 pF	0402	muRata GJM	GJM1555C1H100GB01
M4	Inductor	30 nH	0402	Coilcraft HP	0402HP-30NX_L
M5, M9, M12	Capacitor	100 pF	0402	muRata GRM	GRM1555C1H101JA01D
M6 (RBIAS)	Resistor	15 kΩ (stress 1% tolerance)	0402	Panasonic	ERJ-2RKF1502X
M10	Inductor	36 nH	0402	Coilcraft HP	0402HP-36NX_L
M14, M16	Jumper	0 Ω	0402	Panasonic	ERJ-2GE0R00X
M7, M8, M11, M13, M15, M17 ¹	DNP				

¹ M17 is optional. It is only needed if the control signal is noisy.

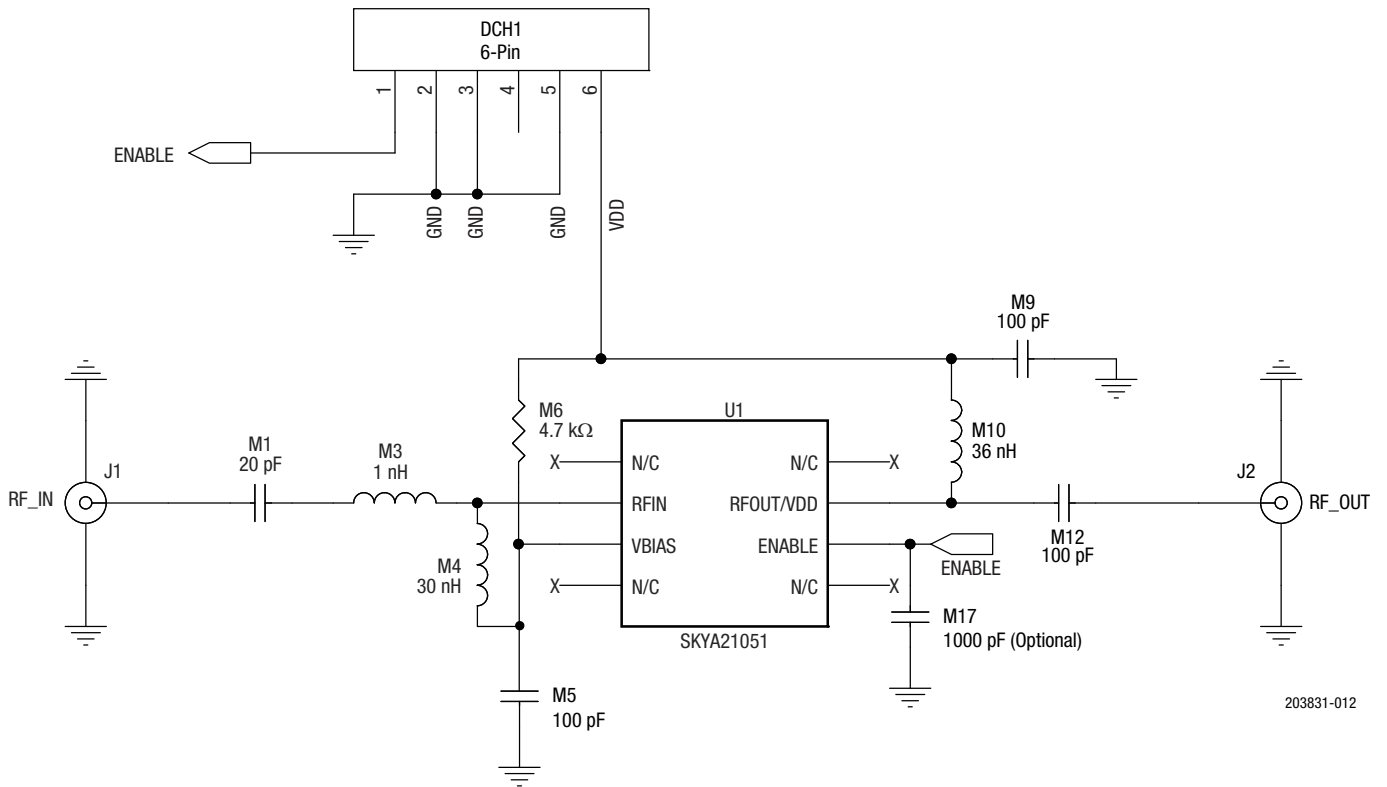

Figure 39. SKYA21051 Evaluation Board Schematic (Optimized for 700 to 2700 MHz)

Table 9. SKYA21051 Evaluation Board Bill of Materials (700 to 2700 MHz)

Component	Description	Value	Size	Manufacturer	Mfr Part Number
M1	Capacitor	20 pF	0402	muRata GJM	GJM1555C1H200JB01
M3	Inductor	1 nH	0402	Coilcraft HP	0402HP-1N0XJL
M4	Inductor	30 nH	0402	Coilcraft HP	0402HP-30NX_L
M5, M9, M12	Capacitor	100 pF	0402	muRata GRM	GRM1555C1H101JA01D
M6 (RBIAS)	Resistor	4.7 kΩ (stress 1% tolerance)	0402	Panasonic	ERJ-2RKF4701X
M10	Inductor	36 nH	0402	Coilcraft HP	0402HP-36NX_L
M14, M16	Jumper	0 Ω	0402	Panasonic	ERJ-2GE0R00X
M2, M7, M8, M11, M13, M15, M17 ¹	DNP				

¹ M17 is optional. It is only needed if the control signal is noisy.

Table 10. SKYA21051 Evaluation Board Bill of Materials (3400 to 5000 MHz)

Component	Description	Value	Size	Manufacturer	Mfr Part Number
M1	Capacitor	20 pF	402	muRata	GJM1555C1H200GB01
M2	Capacitor	0.5 pF	402	muRata	GJM1555C1HR50WB01
M3	Resistor	0 Ω	402	NA	NA
M4	Resistor	1 k Ω	402	NA	NA
M5	Capacitor	100 pF	402	muRata	GRM1555C1H101JA01
M6	Resistor	8.2 k Ω	402	NA	NA
M8	Capacitor	.01 uF	402	muRata	GRM1555R71H103KA88
M9	Capacitor	1000 pF	402	muRata	GRM1555C1H100JZ01
M10	Inductor	9.1 nH	402	muRata	LQG15HS9N1J02
M12	Inductor	1.5 nH	402	muRata	LQP15MN1N5B02
M13	Capacitor	0.5 pF	402	muRata	GJM1555C1HR50WB01
M14	Capacitor	100 pF	402	muRata	GRM1555C1H101JA01
M16	Resistor	0 Ω	402	NA	NA
M17	Capacitor	100 pF	402	muRata	GRM1555C1H101JA01

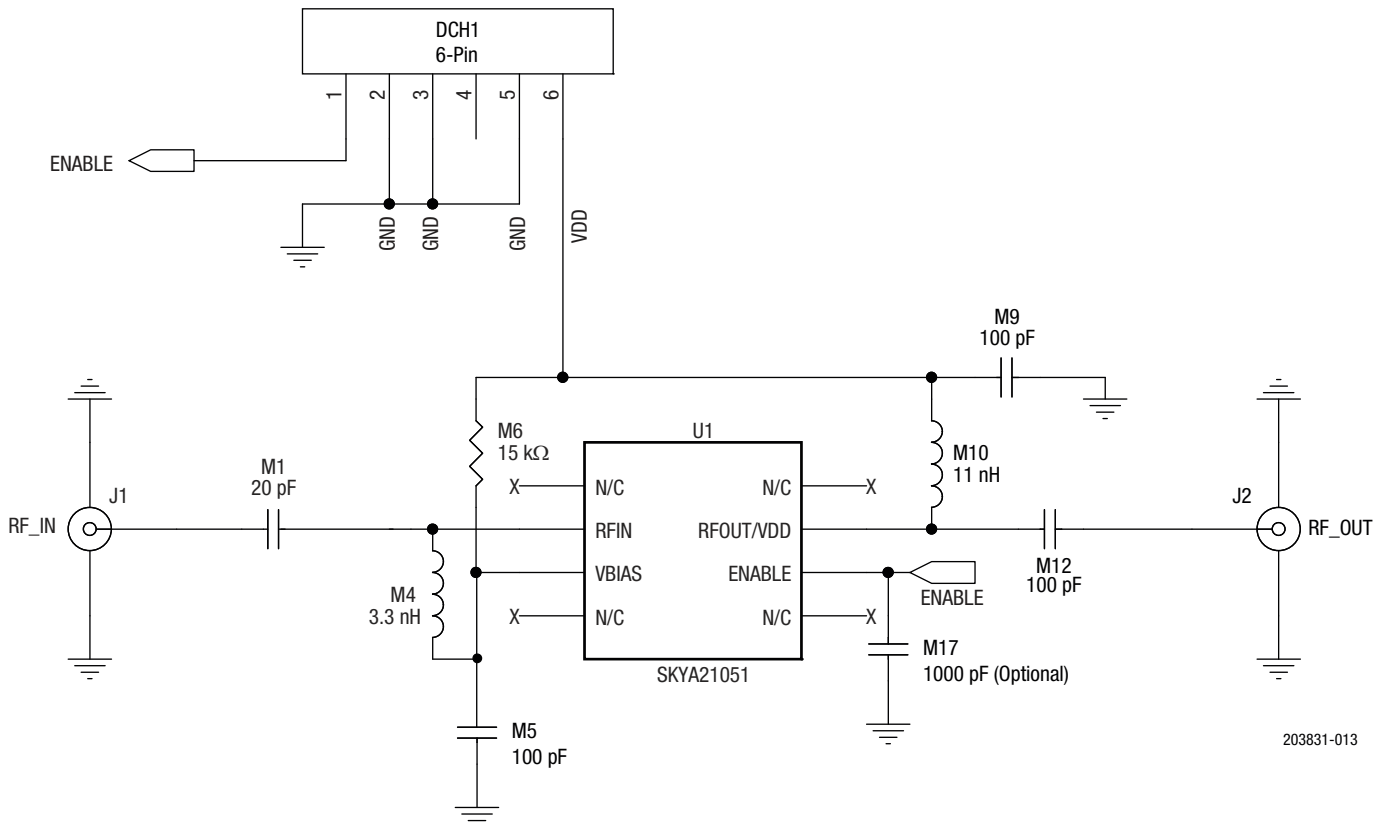
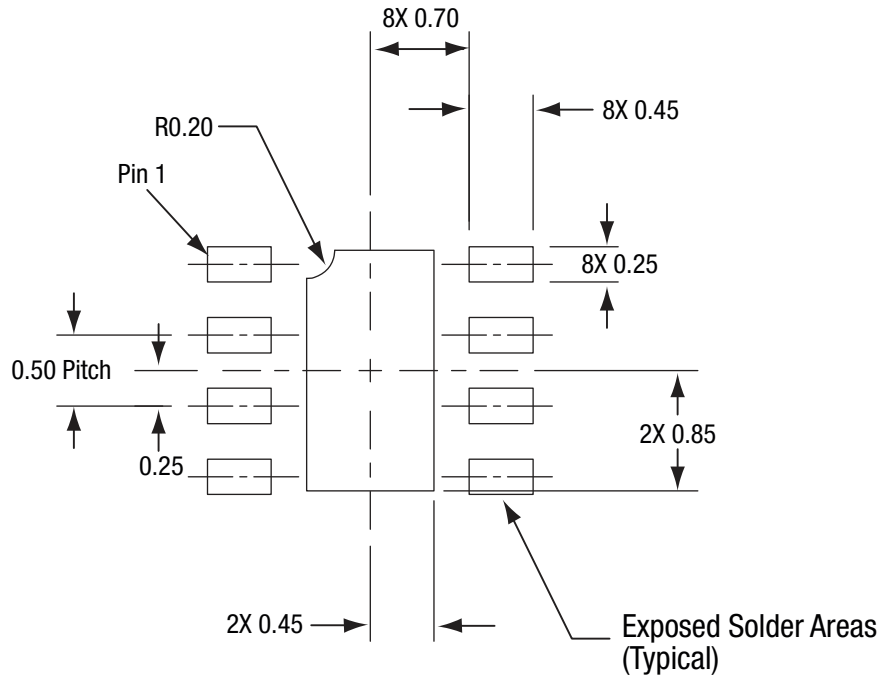

Figure 40. SKYA21051 Evaluation Board Schematic (Optimized for 3400 to 3800 MHz)

Table 11. SKYA21051 Evaluation Board Bill of Materials (3400 to 3800 MHz)

Component	Description	Value	Size	Manufacturer	Part Number
M1	Capacitor	20 pF	0402	muRata GJM	GJM1555C1H200JB01
M4	Inductor	3.3 nH	0402	Coilcraft HP	0402HP-3N3X_L
M5, M9, M12	Capacitor	100 pF	0402	muRata GRM	GRM1555C1H101JA01D
M6 (RBIAS)	Resistor	15 kΩ	0402	Panasonic	Any
M10	Inductor	11 nH	0402	Coilcraft HP	0402HP-11NX_L
M3, M14, M16	Jumper	0 Ω	0402	Panasonic	ERJ-2GE0R00X
M2, M7, M8, M11, M13, M15, M17 ¹	DNP				

¹ M17 is optional. It is only needed if the control signal is noisy.



All dimensions are in millimeters

203831-014

Figure 41. SKYA21051 PCB Layout Footprint (Top View)

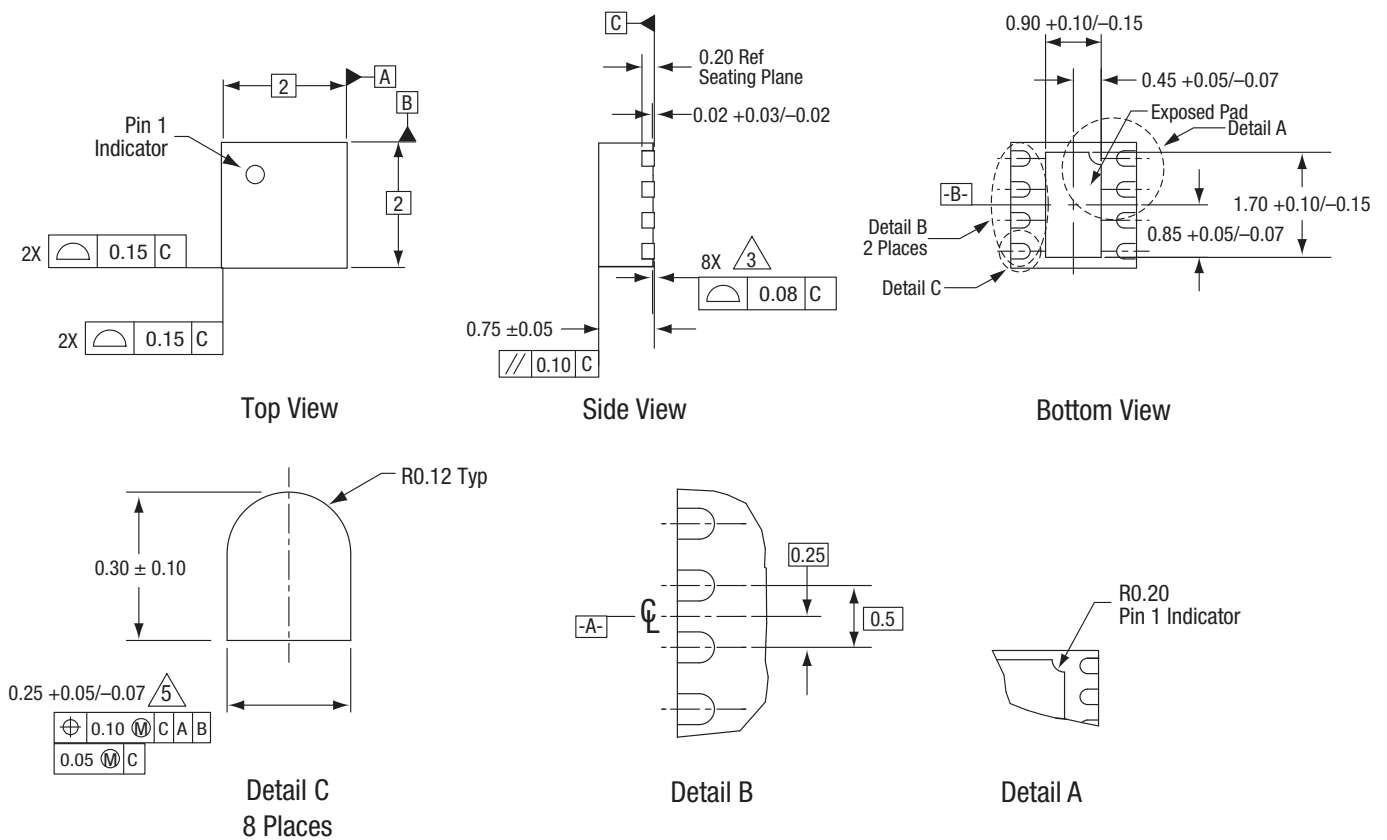

Notes:

1. All measurements are in millimeters.
2. Dimensions and tolerances according to ASME Y14.5M-1994.
3. Coplanarity applies to the exposed heat sink ground pad as well as the terminals.
4. Plating requirement per source control drawing (SCD) 2504.
5. Dimension applies to metallized terminal and is measured between 0.15 mm and 0.30 mm from terminal tip.

203831-015

Figure 42. SKYA21051 Package Dimensions

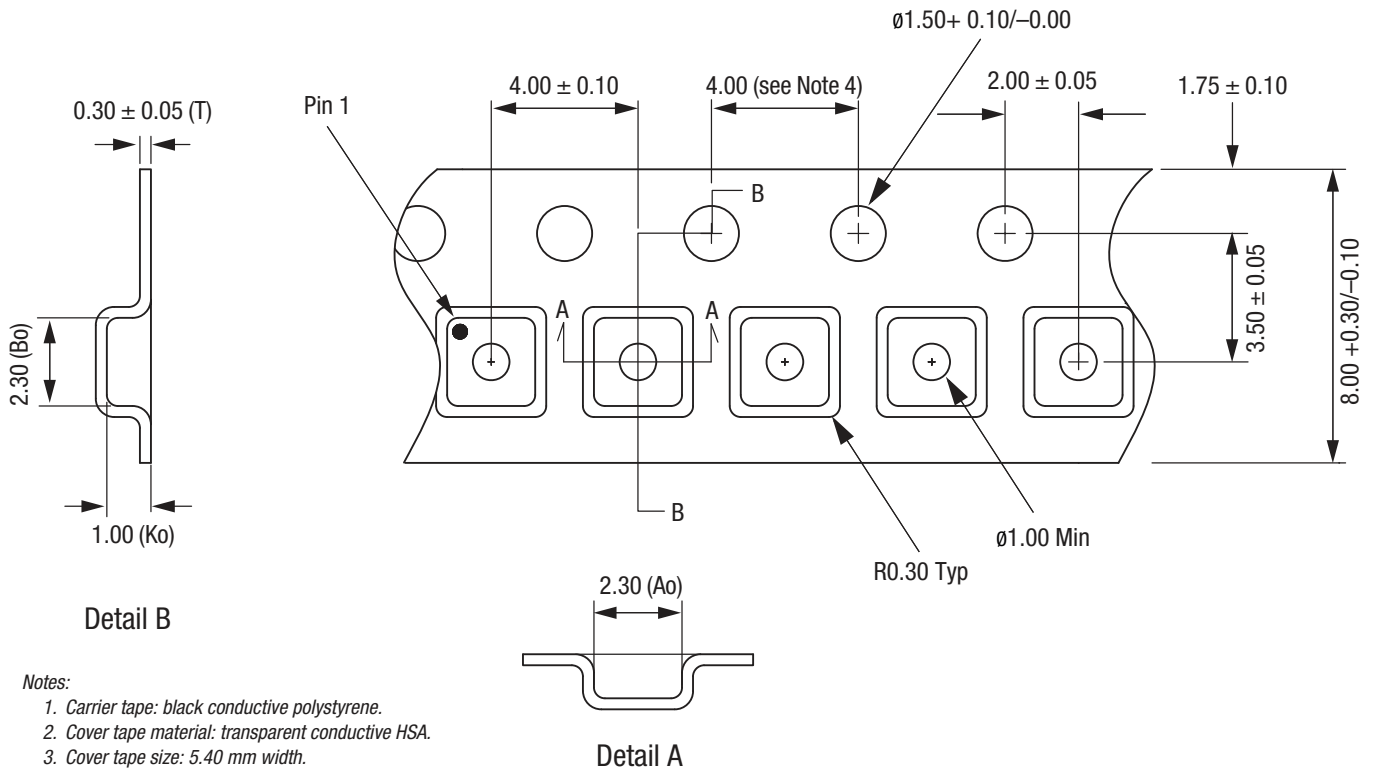

Notes:

1. Carrier tape: black conductive polystyrene.
2. Cover tape material: transparent conductive HSA.
3. Cover tape size: 5.40 mm width.
4. Ten sprocket hole pitch cumulative tolerance = ± 0.20 mm.
5. ESD surface resistivity is $\leq 1 \times 10^8$ Ohms/square per EIA, JEDEC tape and reel specification.
6. Ao and Bo measurement point to be 0.30 mm from bottom pocket.
7. All measurements are in millimeters.

203831-015

Figure 43. SKYA21051 Tape and Reel Dimensions

Ordering Information

Part Number	Product Description	Evaluation Board Part Number
SKYA21051	200 to 6000 MHz Broadband Low-Noise Amplifier	SKYA21051EK1 (700 to 2700 MHz low frequency range) SKYA21051EK2 (3400 to 3800 MHz next frequency range)

Copyright © 2016, 2018-2019 Skyworks Solutions, Inc. All Rights Reserved.

Information in this document is provided in connection with Skyworks Solutions, Inc. (“Skyworks”) products or services. These materials, including the information contained herein, are provided by Skyworks as a service to its customers and may be used for informational purposes only by the customer. Skyworks assumes no responsibility for errors or omissions in these materials or the information contained herein. Skyworks may change its documentation, products, services, specifications or product descriptions at any time, without notice. Skyworks makes no commitment to update the materials or information and shall have no responsibility whatsoever for conflicts, incompatibilities, or other difficulties arising from any future changes.

No license, whether express, implied, by estoppel or otherwise, is granted to any intellectual property rights by this document. Skyworks assumes no liability for any materials, products or information provided hereunder, including the sale, distribution, reproduction or use of Skyworks products, information or materials, except as may be provided in Skyworks Terms and Conditions of Sale.

THE MATERIALS, PRODUCTS AND INFORMATION ARE PROVIDED “AS IS” WITHOUT WARRANTY OF ANY KIND, WHETHER EXPRESS, IMPLIED, STATUTORY, OR OTHERWISE, INCLUDING FITNESS FOR A PARTICULAR PURPOSE OR USE, MERCHANTABILITY, PERFORMANCE, QUALITY OR NON-INFRINGEMENT OF ANY INTELLECTUAL PROPERTY RIGHT; ALL SUCH WARRANTIES ARE HEREBY EXPRESSLY DISCLAIMED. SKYWORKS DOES NOT WARRANT THE ACCURACY OR COMPLETENESS OF THE INFORMATION, TEXT, GRAPHICS OR OTHER ITEMS CONTAINED WITHIN THESE MATERIALS. SKYWORKS SHALL NOT BE LIABLE FOR ANY DAMAGES, INCLUDING BUT NOT LIMITED TO ANY SPECIAL, INDIRECT, INCIDENTAL, STATUTORY, OR CONSEQUENTIAL DAMAGES, INCLUDING WITHOUT LIMITATION, LOST REVENUES OR LOST PROFITS THAT MAY RESULT FROM THE USE OF THE MATERIALS OR INFORMATION, WHETHER OR NOT THE RECIPIENT OF MATERIALS HAS BEEN ADVISED OF THE POSSIBILITY OF SUCH DAMAGE.

Skyworks products are not intended for use in medical, lifesaving or life-sustaining applications, or other equipment in which the failure of the Skyworks products could lead to personal injury, death, physical or environmental damage. Skyworks customers using or selling Skyworks products for use in such applications do so at their own risk and agree to fully indemnify Skyworks for any damages resulting from such improper use or sale.

Customers are responsible for their products and applications using Skyworks products, which may deviate from published specifications as a result of design defects, errors, or operation of products outside of published parameters or design specifications. Customers should include design and operating safeguards to minimize these and other risks. Skyworks assumes no liability for applications assistance, customer product design, or damage to any equipment resulting from the use of Skyworks products outside of stated published specifications or parameters.

Skyworks and the Skyworks symbol are trademarks or registered trademarks of Skyworks Solutions, Inc. or its subsidiaries in the United States and other countries. Third-party brands and names are for identification purposes only, and are the property of their respective owners. Additional information, including relevant terms and conditions, posted at www.skyworksinc.com, are incorporated by reference.