

# KSPS SERIES



## Description

The KSPS Series is a factory programmed module available in any 1 of 14 standard functions. The KSPS Series offers a single, fixed, externally or onboard adjustable time delay. The 1A steady, 10A inrush rated solid-state output provides 100 million operations typical. Its microcontroller timing circuit provides excellent repeat accuracy and stability. Encapsulation protects against shock, vibration, and humidity. The KSPS Series is a cost effective approach for OEM applications that require small size and solid state reliability.

## Features & Benefits

FEATURES	BENEFITS
<b>Microcontroller based</b>	Repeat Accuracy +/- 0.5%
<b>Compact design</b>	Allows flexibility for OEM applications
<b>1A steady, 10A inrush solid-state output</b>	Provides 100 million operations in typical conditions.
<b>Totally solid state and encapsulated</b>	No moving parts to arc and wear out over time and encapsulated to protect against shock, vibration, and humidity

## Wiring Diagram

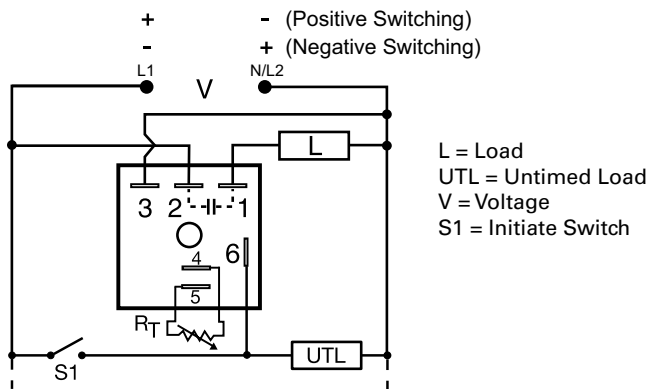

## Accessories

- P1004-95, P1004-95-X Versa-Pot**  
 Panel mountable, industrial potentiometer recommended for remote time delay adjustment.
- P0700-7 Versa-Knob**  
 Designed for 0.25 in. (6.35 mm) shaft of Versa-Pot. Semi-gloss industrial black finish.
- P1015-64 (AWG 14/16)**  
 Female Quick Connect  
 These 0.25 in. (6.35 mm) female terminals are constructed with an insulator barrel to provide strain relief.
- P1015-18 Quick Connect to Screw Adapter**  
 Screw adapter terminal designed for use with all modules with 0.25 in. (6.35 mm) male quick connect terminals.

## Ordering Information

MODEL	INPUT VOLTAGE	ADJUSTMENT	TIME DELAY	FUNCTION
KSPS2180SB	24VAC	Fixed	80s	Delay-on-Break
KSPSA21FT	24 - 240VAC, positive switching	Onboard	0.1 - 10s	Recycling, On Time First
KSPSN13MI	12 - 120VDC, negative switching	Fixed	3m	Interval
KSPSN21B	12 - 120VDC, negative switching	Onboard	0.1 - 10s	Delay-on-Break
KSPSP145SM	12 - 120VDC, positive switching	Fixed	45s	Delay-on-Make
KSPSP22B	12 - 120VDC, positive switching	Onboard	1 - 100s	Delay-on-Break
KSPSP35PSD	12 - 120VDC, positive switching	External	1 - 100m	Retriggerable Single Shot

If you don't find the part you need, call us for a custom product 800-843-8848

## KSPS SERIES

### Accessories



**C103PM (AL) DIN Rail**  
35 mm aluminum DIN rail available in a 36 in. (91.4 cm) length.



**P1023-20 DIN Rail Adapter**  
Allows module to be mounted on a 35 mm DIN type rail with two #10 screws.

### Specifications

#### Time Delay

<b>Type</b>	Microcontroller circuitry
<b>Range</b>	0.1s - 1000h in 9 adjustable ranges or fixed
<b>Repeat Accuracy</b>	±0.5% or 20ms, whichever is greater
<b>Tolerance</b>	
<b>(Factory Calibration)</b>	≤ ±2%
<b>Reset Time</b>	≤ 150ms
<b>Initiate Time</b>	≤ 20ms; ≤ 1500 operations per minute
<b>Time Delay vs Temp. &amp; Voltage</b>	≤ ±2%

#### Input

<b>Voltage</b>	12 to 120VDC; 24 to 240VAC
<b>Tolerance</b>	≤ ±15%
<b>AC Line Frequency/DC Ripple</b>	50/60Hz / ≤ 10%
<b>Power Consumption</b>	AC ≤ 2VA; DC ≤ 1W

#### Output

<b>Type</b>	Solid-state output
<b>Rating</b>	1A steady, 10A inrush for 16ms
<b>Voltage Drop</b>	AC ≅ 2.5V @ 1A; DC ≅ 1V @ 1A
<b>OFF State Leakage Current</b>	AC ≅ 5mA @ 240VAC, DC ≅ 1mA

#### Protection

<b>Circuitry</b>	Encapsulated
<b>Dielectric Breakdown</b>	≥ 2000V RMS terminals to mounting surface
<b>Insulation Resistance</b>	≥ 100 MΩ

#### Polarity

DC units are reverse polarity protected

#### Mechanical

#### Mounting

Surface mt. with one #10 (M5 x 0.8) screw

#### Dimensions

**H** 50.8 mm (2.0"); **W** 50.8 mm (2.0");  
**D** 30.7 mm (1.21")

#### Termination

0.25 in. (6.35 mm) male quick connects

#### Environmental

#### Operating/Storage

-40° to 60°C / -40° to 85°C

#### Humidity

95% relative, non-condensing

#### Weight

≅ 2.4 oz (68 g)

### Timer Functions

#### Operation (Delay-on-Make)

Upon application of the input voltage, the time delay begins. The output relay is de-energized before and during the time delay. At the end of the time delay, the output energizes and remains energized until input voltage is removed.

**Reset:** Removing input voltage resets the time delay and output.

#### Operation (Delay-on-Break)

Input voltage must be applied before and during timing. Upon closure of the initiate switch, the output relay energizes. The time delay begins when the initiate switch is opened. The output remains energized during timing. At the end of the time delay, the output de-energizes. The output will energize if the initiate switch is closed when input voltage is applied.

**Reset:** Re-closing the initiate switch during timing resets the time delay. Removing input voltage resets the time delay and output.

#### Operation (Recycling)

Upon application of input voltage, the output relay energizes and the ON time begins. At the end of the ON time, the output de-energizes and the OFF time begins. At the end of the OFF time, the output energizes and the cycle repeats as long as input voltage is applied.

**Reset:** Removing input voltage resets the output and time delays, and returns the sequence to the first delay.

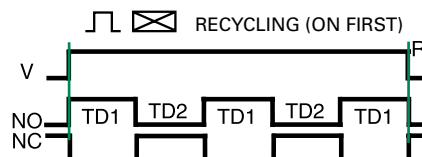
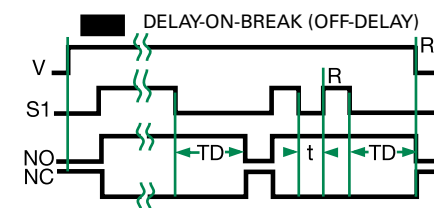
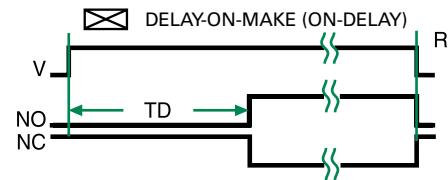

## KSPS SERIES

### Operation (Alternating)

Input voltage must be applied at all times for proper operation. The operation begins with the output relay de-energized. Closing S1 enables the next alternating operation. When S1 opens (trailing edge triggered), the time delay begins. At the end of the time delay, the output energizes and remains energized until S1 is (re-closed and) re-opened. Then the output relay de-energizes and remains until S1 opens again. Each time S1 opens the time delay occurs and the output transfers.

**Reset:** Removing input voltage resets the output and the time delay.

### Operation (Single Shot)

Input voltage must be applied before and during timing. Upon momentary or maintained closure of the initiate switch, the output (relay or solid state) energizes and the time delay begins. At the end of the delay, the output de-energizes. Opening or re-closing the initiate switch during timing has no effect on the time delay. Note (for most single shot timers): If the initiate switch is closed when input voltage is applied, the output energizes and the time delay begins.

**Reset:** Reset occurs when the time delay is complete and the initiate switch is opened. Removing input voltage resets the time delay and output.

### Operation (Trailing Edge Single Shot, Impulse-OFF)

Input voltage must be applied before and during timing. When the initiate switch S1 opens, the output relay energizes. At the end of the time delay, the output de-energizes. Re-closing and opening S1 during timing has no effect on the time delay. The output will not energize if S1 is open when input voltage is applied.

**Reset:** Reset occurs when the time delay is complete and S1 is closed. Removing input voltage resets the time delay and output.

### Operation (Inverted Single Shot)

Input voltage must be applied before and during timing. Upon momentary or maintained closure of the initiate switch S1, the output relay de-energizes. At the end of the time delay, the output energizes. Opening or re-closing S1 during timing has no effect on the time delay. The output will remain de-energized if S1 is closed when input voltage is applied.

**Reset:** Reset occurs when the time delay is complete and S1 is open. Removing input voltage resets the time delay and output.

### Operation (Interval)

Upon application of input voltage, the time delay begins. The output (relay or solid state) energizes during the time delay. At the end of time delay the output de-energizes and remains de-energized until input voltage is removed.

**Reset:** Removing input voltage resets the time delay and output.

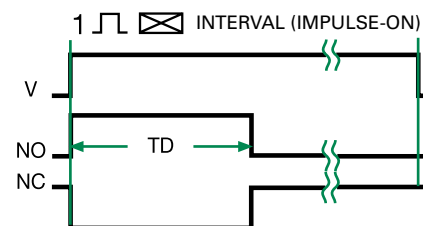
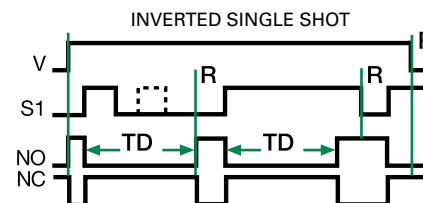
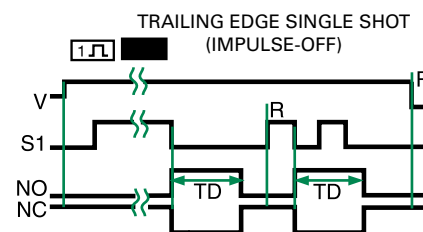
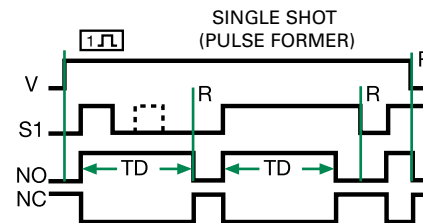
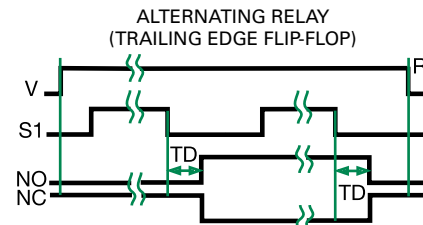

### LEGEND

V = Voltage  
R = Reset  
T1 = ONTime

T2 = OFFTime  
S1 = Initiate Switch  
NO = Normally Open Contact

NC = Normally Closed Contact  
t = Incomplete Time Delay  
TD, TD1, TD2 = Time Delay

C = Count  
P = Pulse Duration  
— = Undefined Time