

**FEATURES**
**3 power modes**
**RMS noise**

 Low power: 24 nV rms at 1.17 SPS, gain = 128 (255  $\mu$ A typical)

 Mid power: 20 nV rms at 2.34 SPS, gain = 128 (355  $\mu$ A typical)

 Full power: 23 nV rms at 9.4 SPS, gain = 128 (930  $\mu$ A typical)

**Up to 22 noise free bits in all power modes (gain = 1)**
**Output data rate**

Full power: 9.38 SPS to 19,200 SPS

Mid power: 2.34 SPS to 4800 SPS

Low power: 1.17 SPS to 2400 SPS

**Rail-to-rail analog inputs for gains > 1**
**Simultaneous 50 Hz/60 Hz rejection at 25 SPS (single cycle settling)**
**Diagnostic functions (which aid safe integrity level (SIL) certification)**
**Crosspoint multiplexed analog inputs**

4 differential/7 pseudo differential inputs

**Programmable gain (1 to 128)**
**Band gap reference with 10 ppm/ $^{\circ}$ C drift maximum (70  $\mu$ A)**
**Matched programmable excitation currents**
**Internal clock oscillator and temperature sensor**
**On-chip bias voltage generator**
**Low-side power switch**
**Multiple filter options**
**Sensor burnout detection**
**Automatic channel sequencer**
**Per channel configuration**
**Power-down current: 5  $\mu$ A maximum**
**24-lead TSSOP**
**3-wire or 4-wire serial interface**

SPI, QSPI, MICROWIRE, and DSP compatible

Schmitt trigger on SCLK

**ENHANCED PRODUCT FEATURES**
**Supports defense and aerospace applications (AQEC standard)**
**Full military temperature range:  $-55^{\circ}$ C to  $+125^{\circ}$ C**
**Controlled manufacturing baseline**
**1 assembly/test site**
**1 fabrication site**
**Product change notification**
**Qualification data available on request**
**APPLICATIONS**
**Military and space**
**Avionics**
**Pressure measurement**
**Instrumentation**
**FUNCTIONAL BLOCK DIAGRAM**

Figure 1.

Rev. 0

[Document Feedback](#)

Information furnished by Analog Devices is believed to be accurate and reliable. However, no responsibility is assumed by Analog Devices for its use, nor for any infringements of patents or other rights of third parties that may result from its use. Specifications subject to change without notice. No license is granted by implication or otherwise under any patent or patent rights of Analog Devices. Trademarks and registered trademarks are the property of their respective owners.

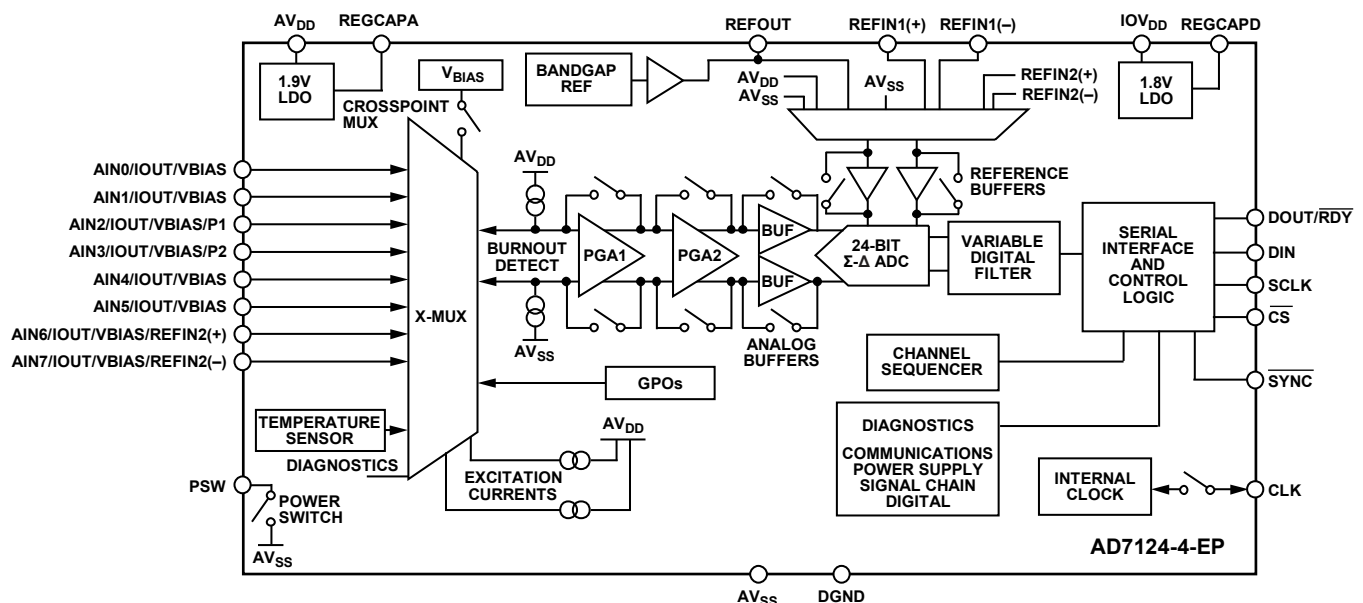
One Technology Way, P.O. Box 9106, Norwood, MA 02062-9106, U.S.A.

Tel: 781.329.4700

©2019 Analog Devices, Inc. All rights reserved.

[Technical Support](#)
[www.analog.com](http://www.analog.com)

**TABLE OF CONTENTS**

Features .....	1	Thermal Resistance .....	10
Enhanced Product Features .....	1	ESD Caution.....	10
Applications.....	1	Pin Configuration and Function Descriptions.....	11
Functional Block Diagram .....	1	Typical Performance Characteristics .....	13
Revision History .....	2	Outline Dimensions .....	17
General Description .....	3	Ordering Guide .....	17
Specifications.....	4		
Absolute Maximum Ratings.....	10		

**REVISION HISTORY**

**4/2019—Revision 0: Initial Version**

## GENERAL DESCRIPTION

The AD7124-4-EP is a low power, low noise, completely integrated analog front end for high precision measurement applications. The device contains a low noise, 24-bit  $\Sigma$ - $\Delta$  analog-to-digital converter (ADC), and can be configured to have four differential inputs or seven single-ended or pseudo differential inputs. The on-chip low gain stage ensures that signals of small amplitude can be interfaced directly to the ADC.

One of the major advantages of the AD7124-4-EP is that it gives the user the flexibility to employ one of three integrated power modes. The current consumption, range of output data rates, and rms noise can be tailored with the power mode selected. The device also offers a multitude of filter options, ensuring that the user has the highest degree of flexibility.

The AD7124-4-EP can achieve simultaneous 50 Hz and 60 Hz rejection when operating at an output data rate of 25 SPS (single cycle settling), with rejection in excess of 80 dB achieved at lower output data rates.

The AD7124-4-EP establishes the highest degree of signal chain integration. The device contains a precision, low noise, low drift internal band gap reference, and also accepts an external differential reference, which can be internally buffered. Other key integrated features include programmable low drift excitation current sources, burnout currents, and a bias voltage generator, which sets the common-mode voltage of a channel to  $AV_{DD}/2$ . The low-side power switch enables the user to power down bridge sensors between conversions, ensuring the absolute minimal power consumption of the system. The device also allows the user the option of operating with either an internal clock or an external clock.

The integrated channel sequencer allows several channels to be enabled simultaneously, and the AD7124-4-EP sequentially

converts on each enabled channel, simplifying communication with the device. As many as 16 channels can be enabled at any time; a channel being defined as an analog input or a diagnostic such as a power supply check or a reference check. This unique feature allows diagnostics to be interleaved with conversions. The AD7124-4-EP also supports per channel configuration. The device allows eight configurations or setups. Each configuration consists of gain, filter type, output data rate, buffering, and reference source. The user can assign any of these setups on a channel by channel basis.

The AD7124-4-EP also has extensive diagnostic functionality integrated as part of its comprehensive feature set. These diagnostics include a cyclic redundancy check (CRC), signal chain checks, and serial interface checks, which lead to a more robust solution. These diagnostics reduce the need for external components to implement diagnostics, resulting in reduced board space needs, reduced design cycle times, and cost savings. The failure modes effects and diagnostic analysis (FMEDA) of a typical application has shown a safe failure fraction (SFF) greater than 90% according to IEC 61508.

The device operates with a single analog power supply from 2.7 V to 3.6 V or a dual 1.8 V power supply. The digital supply has a range of 1.65 V to 3.6 V. It is specified for the full military temperature range of  $-55^{\circ}\text{C}$  to  $+125^{\circ}\text{C}$ . The AD7124-4-EP is housed in a 24-lead TSSOP package.

Note that, throughout this data sheet, multifunction pins, such as  $\overline{\text{DOUT}}/\overline{\text{RDY}}$ , are referred to either by the entire pin name or by a single function of the pin, for example,  $\overline{\text{RDY}}$ , when only that function is relevant.

Additional application and technical information can be found in the [AD7124-4](#) data sheet.

## SPECIFICATIONS

$AV_{DD} = 2.9\text{ V to }3.6\text{ V}$  (full power mode),  $2.7\text{ V to }3.6\text{ V}$  (mid and low power mode),  $IOV_{DD} = 1.65\text{ V to }3.6\text{ V}$ ,  $AV_{SS} = DGND = 0\text{ V}$ ,  $REFIN_{x(+)} = 2.5\text{ V}$ ,  $REFIN_{x(-)} = AV_{SS}$ , master clock = 614.4 kHz, all specifications  $T_{MIN}$  to  $T_{MAX}$ , unless otherwise noted.

**Table 1.**

Parameter <sup>1</sup>	Min	Typ	Max	Unit	Test Conditions/Comments
ADC					
Output Data Rate, $f_{ADC}$					
Low Power Mode	1.17		2400	SPS	
Mid Power Mode	2.34		4800	SPS	
Full Power Mode	9.38		19,200	SPS	
No Missing Codes <sup>2</sup>	24			Bits	$FS^3 > 2$ , sinc <sup>4</sup> filter
	24			Bits	$FS^3 > 8$ , sinc <sup>3</sup> filter
Resolution					
RMS Noise and Update Rates					
Integral Nonlinearity (INL)	-4	±1	+4	ppm of FSR	Gain = 1 <sup>2</sup>
	-15	±2	+15	ppm of FSR	Gain > 1 <sup>4</sup>
Offset Error <sup>5</sup>					
Before Calibration		±15		µV	Gain = 1 to 8
After Internal Calibration/System Calibration		200/gain In order of noise		µV	Gain = 16 to 128
Offset Error Drift vs. Temperature <sup>6</sup>					
Low Power Mode		10		nV/°C	Gain = 1 or gain > 16
		80		nV/°C	Gain = 2 to 8
Mid Power Mode		40		nV/°C	Gain = 16
		10		nV/°C	Gain = 1 or gain > 16
		40		nV/°C	Gain = 2 to 8
Full Power Mode		20		nV/°C	Gain = 16
		10		nV/°C	
Gain Error <sup>5,7</sup>					
Before Internal Calibration	-0.0025		+0.0025	%	Gain = 1, $T_A = 25^\circ\text{C}$
		-0.3		%	Gain > 1
After Internal Calibration	-0.016	+0.004	+0.016	%	Gain = 2 to 8, $T_A = 25^\circ\text{C}$
		±0.025		%	Gain = 16 to 128
After System Calibration		In order of noise			
Gain Error Drift vs. Temperature		1	2	ppm/°C	
Power Supply Rejection					$A_{IN} = 1\text{ V/gain}$ , external reference
Low Power Mode	87			dB	Gain = 2 to 16
	96			dB	Gain = 1 or gain > 16
Mid Power Mode <sup>2</sup>	92			dB	Gain = 2 to 16
	100			dB	Gain = 1 or gain > 16
Full Power Mode	99			dB	
Common-Mode Rejection <sup>8</sup>					
At DC <sup>2</sup>	85	90		dB	$A_{IN} = 1\text{ V}$ , gain = 1
	105	115		dB	$A_{IN} = 1\text{ V/gain}$ , gain 2 or 4
	102 <sup>9,2</sup>			dB	$A_{IN} = 1\text{ V/gain}$ , gain 2 or 4
	115	120		dB	$A_{IN} = 1\text{ V/gain}$ , gain ≥ 8
	105 <sup>9,2</sup>			dB	$A_{IN} = 1\text{ V/gain}$ , gain ≥ 8
Sinc <sup>3</sup> , Sinc <sup>4</sup> Filter <sup>2</sup>					
At 50 Hz, 60 Hz	120			dB	10 SPS, 50 Hz ± 1 Hz, 60 Hz ± 1 Hz
At 50 Hz	120			dB	50 SPS, 50 Hz ± 1 Hz
At 60 Hz	120			dB	60 SPS, 60 Hz ± 1 Hz

Parameter <sup>1</sup>	Min	Typ	Max	Unit	Test Conditions/Comments
Fast Settling Filters <sup>2</sup>					
At 50 Hz	115			dB	First notch at 50 Hz, 50 Hz ± 1 Hz
At 60 Hz	115			dB	First notch at 60 Hz, 60 Hz ± 1 Hz
Post Filters <sup>2</sup>					
At 50 Hz, 60 Hz	130			dB	20 SPS, 50 Hz ± 1 Hz, 60 Hz ± 1 Hz
	130			dB	25 SPS, 50 Hz ± 1 Hz, 60 Hz ± 1 Hz
Normal Mode Rejection <sup>2</sup>					
Sinc <sup>4</sup> Filter					
External Clock					
At 50 Hz, 60 Hz	120			dB	10 SPS, 50 Hz ± 1 Hz, 60 Hz ± 1 Hz
	80			dB	50 SPS, REJ60 <sup>10</sup> =1, 50 Hz ± 1 Hz, 60 Hz ± 1 Hz
At 50 Hz	120			dB	50 SPS, 50 Hz ± 1 Hz
At 60 Hz	120			dB	60 SPS, 60 Hz ± 1 Hz
Internal Clock					
At 50 Hz, 60 Hz	98			dB	10 SPS, 50 Hz ± 1 Hz, 60 Hz ± 1 Hz
	66			dB	50 SPS, REJ60 <sup>10</sup> = 1, 50 Hz ± 1 Hz, 60 Hz ± 1 Hz
At 50 Hz	92			dB	50 SPS, 50 Hz ± 1 Hz
At 60 Hz	92			dB	60 SPS, 60 Hz ± 1 Hz
Sinc <sup>3</sup> Filter					
External Clock					
At 50 Hz, 60 Hz	100			dB	10 SPS, 50 Hz ± 1 Hz, 60 Hz ± 1 Hz
	65			dB	50 SPS, REJ60 <sup>10</sup> = 1, 50 Hz ± 1 Hz, 60 Hz ± 1 Hz
At 50 Hz	100			dB	50 SPS, 50 Hz ± 1 Hz
At 60 Hz	100			dB	60 SPS, 60 Hz ± 1 Hz
Internal Clock					
At 50 Hz, 60 Hz	73			dB	10 SPS, 50 Hz ± 1 Hz, 60 Hz ± 1 Hz
	52			dB	50 SPS, REJ60 <sup>10</sup> = 1, 50 Hz ± 1 Hz, 60 Hz ± 1 Hz
At 50 Hz	68			dB	50 SPS, 50 Hz ± 1 Hz
At 60 Hz	68			dB	60 SPS, 60 Hz ± 1 Hz
Fast Settling Filters					
External Clock					
At 50 Hz	40			dB	First notch at 50 Hz, 50 Hz ± 0.5 Hz
At 60 Hz	40			dB	First notch at 60 Hz, 60 Hz ± 0.5 Hz
Internal Clock					
At 50 Hz	24.5			dB	First notch at 50 Hz, 50 Hz ± 0.5 Hz
At 60 Hz	24.5			dB	First notch at 60 Hz, 60 Hz ± 0.5 Hz
Post Filters					
External Clock					
At 50 Hz, 60 Hz	86			dB	20 SPS, 50 Hz ± 1 Hz, 60 Hz ± 1 Hz
	62			dB	25 SPS, 50 Hz ± 1 Hz, 60 Hz ± 1 Hz
Internal Clock					
At 50 Hz, 60 Hz	67			dB	20 SPS, 50 Hz ± 1 Hz, 60 Hz ± 1 Hz
	50			dB	25 SPS, 50 Hz ± 1 Hz, 60 Hz ± 1 Hz

Parameter <sup>1</sup>	Min	Typ	Max	Unit	Test Conditions/Comments
<b>ANALOG INPUTS<sup>11</sup></b>					
Differential Input Voltage Ranges <sup>12</sup>		$\pm V_{REF}/\text{gain}$		V	$V_{REF} = \text{REFINx}(+) - \text{REFINx}(-)$ , or internal reference
Absolute A <sub>IN</sub> Voltage Limits <sup>2</sup>					
Gain = 1 (Unbuffered)	$AV_{SS} - 0.05$		$AV_{DD} + 0.05$	V	
Gain = 1 (Buffered)	$AV_{SS} + 0.1$		$AV_{DD} - 0.1$	V	
Gain > 1	$AV_{SS} - 0.05$		$AV_{DD} + 0.05$	V	
Analog Input Current					
Gain > 1 or Gain = 1 (Buffered)					
Low Power Mode					
Absolute Input Current		$\pm 1$		nA	
Differential Input Current		$\pm 0.2$		nA	
Analog Input Current Drift		25		pA/°C	
Mid Power Mode					
Absolute Input Current		$\pm 1.2$		nA	
Differential Input Current		$\pm 0.4$		nA	
Analog Input Current Drift		25		pA/°C	
Full Power Mode					
Absolute Input Current		$\pm 3.3$		nA	
Differential Input Current		$\pm 1.5$		nA	
Analog Input Current Drift		25		pA/°C	
Gain = 1 (Unbuffered)					Current varies with input voltage
Absolute Input Current		$\pm 2.65$		$\mu\text{A}/\text{V}$	
Analog Input Current Drift		1.1		nA/V/°C	
<b>REFERENCE INPUT</b>					
Internal Reference					
Initial Accuracy	2.5 – 0.2%	2.5	2.5 + 0.2%	V	$T_A = 25^\circ\text{C}$
Drift		2	10	ppm/°C	
Output Current			10	mA	
Load Regulation		50		$\mu\text{V}/\text{mA}$	
Power Supply Rejection		85		dB	
External Reference					
External REFIN Voltage <sup>2</sup>	0.5	2.5	$AV_{DD}$	V	$\text{REFIN} = \text{REFINx}(+) - \text{REFINx}(-)$
Absolute REFIN Voltage Limits <sup>2</sup>	$AV_{SS} - 0.05$		$AV_{DD} + 0.05$	V	Unbuffered
	$AV_{SS} + 0.1$		$AV_{DD} - 0.1$	V	Buffered
Reference Input Current					
Buffered					
Low Power Mode					
Absolute Input Current		$\pm 0.5$		nA	
Reference Input Current Drift		10		pA/°C	
Mid Power Mode					
Absolute Input Current		$\pm 1$		nA	
Reference Input Current Drift		10		pA/°C	
Full Power Mode					
Absolute Input Current		$\pm 3$		nA	
Reference Input Current Drift		10		pA/°C	
Unbuffered					
Absolute Input Current		$\pm 12$		$\mu\text{A}$	
Reference Input Current Drift		6		nA/°C	
Normal Mode Rejection					Same as for analog inputs
Common-Mode Rejection		100		dB	

Parameter <sup>1</sup>	Min	Typ	Max	Unit	Test Conditions/Comments
EXCITATION CURRENT SOURCES (IOUT0/IOUT1)					Available on any analog input pin
Output Current		50/100/250/ 500/750/1000		μA	
Initial Tolerance		±4		%	T <sub>A</sub> = 25°C
Drift		50		ppm/°C	
Current Matching		±0.5		%	Matching between IOUT0 and IOUT1, V <sub>OUT</sub> = 0 V
Drift Matching <sup>2</sup>		5	30	ppm/°C	
Line Regulation (AV <sub>DD</sub> )		2		%/V	AV <sub>DD</sub> = 3 V ± 5%
Load Regulation		0.2		%/V	
Output Compliance <sup>2</sup>	AV <sub>SS</sub> – 0.05		AV <sub>DD</sub> – 0.37	V	50 μA/100 μA/250 μA/500 μA current sources, 2% accuracy
	AV <sub>SS</sub> – 0.05		AV <sub>DD</sub> – 0.48	V	750 μA and 1000 μA current sources, 2% accuracy
BIAS VOLTAGE (V <sub>BIAS</sub> ) GENERATOR					Available on any analog input pin
V <sub>BIAS</sub>		AV <sub>SS</sub> + (AV <sub>DD</sub> – AV <sub>SS</sub> )/2		V	
V <sub>BIAS</sub> Generator Start-Up Time		6.7		μs/nF	Dependent on the capacitance connected to AINx
TEMPERATURE SENSOR					
Accuracy		±0.5		°C	
Sensitivity		13,584		Codes/°C	
LOW-SIDE POWER SWITCH					
On Resistance (R <sub>ON</sub> )		7	10	Ω	
Allowable Current <sup>2</sup>			30	mA	Continuous current
BURNOUT CURRENTS					
A <sub>IN</sub> Current		0.5/2/4		μA	Analog inputs must be buffered
DIGITAL OUTPUTS (P1 AND P2)					
Output Voltage					
High, V <sub>OH</sub>	AV <sub>DD</sub> – 0.6			V	I <sub>SOURCE</sub> = 100 μA
Low, V <sub>OL</sub>			0.4	V	I <sub>SINK</sub> = 100 μA
DIAGNOSTICS					
Power Supply Monitor Detect Level					
Analog Low Dropout Regulator (ALDO)			1.6	V	AV <sub>DD</sub> – AV <sub>SS</sub> ≥ 2.7 V
Digital LDO (DLDO)			1.55	V	IOV <sub>DD</sub> ≥ 1.75 V
Reference Detect Level	0.7		1	V	REF_DET_ERR bit active if V <sub>REF</sub> < 0.7 V
AINM/AINP Overvoltage Detect Level	AV <sub>DD</sub> + 0.04			V	
AINM/AINP Undervoltage Detect Level			AV <sub>SS</sub> – 0.04	V	
INTERNAL/EXTERNAL CLOCK					
Internal Clock					
Frequency	614.4 – 5%	614.4	614.4 + 5%	kHz	
Duty Cycle		50:50		%	
External Clock					
Frequency		2.4576		MHz	Internal divide by 4
Duty Cycle Range		45:55 to 55:45		%	
LOGIC INPUTS <sup>2</sup>					
Input Voltage					
Low, V <sub>INL</sub>			0.3 × IOV <sub>DD</sub>	V	1.65 V ≤ IOV <sub>DD</sub> < 1.9 V
			0.35 × IOV <sub>DD</sub>	V	1.9 V ≤ IOV <sub>DD</sub> < 2.3 V
			0.7	V	2.3 V ≤ IOV <sub>DD</sub> ≤ 3.6 V
High, V <sub>INH</sub>	0.7 × IOV <sub>DD</sub>			V	1.65 V ≤ IOV <sub>DD</sub> < 1.9 V
	0.65 × IOV <sub>DD</sub>			V	1.9 V ≤ IOV <sub>DD</sub> < 2.3 V
	1.7			V	2.3 V ≤ IOV <sub>DD</sub> < 2.7 V
	2			V	2.7 V ≤ IOV <sub>DD</sub> ≤ 3.6 V
Hysteresis	0.2		0.6	V	1.65 V ≤ IOV <sub>DD</sub> ≤ 3.6 V
Input Currents	–1		+1	μA	V <sub>IN</sub> = IOV <sub>DD</sub> or GND
Input Capacitance		10		pF	All digital inputs

Parameter <sup>1</sup>	Min	Typ	Max	Unit	Test Conditions/Comments
<b>LOGIC OUTPUTS (INCLUDING CLK)</b>					
Output Voltage <sup>2</sup>					
High, V <sub>OH</sub>	IOV <sub>DD</sub> – 0.35			V	I <sub>SOURCE</sub> = 100 μA
Low, V <sub>OL</sub>			0.4	V	I <sub>SINK</sub> = 100 μA
Floating State Leakage Current	–1		+1	μA	
Floating State Output Capacitance		10		pF	
Data Output Coding		Offset binary			
<b>SYSTEM CALIBRATION<sup>2</sup></b>					
Calibration Limit					
Full Scale (FS)			1.05 × FS	V	
Zero Scale	–1.05 × FS			V	
Input Span	0.8 × FS		2.1 × FS	V	
<b>POWER SUPPLY VOLTAGES FOR ALL POWER MODES</b>					
AV <sub>DD</sub> to AV <sub>SS</sub>					
Low Power Mode	2.7		3.6	V	
Mid Power Mode	2.7		3.6	V	
Full Power Mode	2.9		3.6	V	
IOV <sub>DD</sub> to GND	1.65		3.6	V	
AV <sub>SS</sub> to GND	–1.8		0	V	
IOV <sub>DD</sub> to AV <sub>SS</sub>			5.4	V	
<b>POWER SUPPLY CURRENTS<sup>11,13</sup></b>					
I <sub>AVDD</sub> , External Reference					
Low Power Mode					
Gain = 1 <sup>2</sup>		125	140	μA	All buffers off
Gain = 1 I <sub>AVDD</sub> Increase per AINx Buffer <sup>2</sup>		15	25	μA	
Gain = 2 to 8		205	250	μA	
Gain = 16 to 128		235	300	μA	
I <sub>AVDD</sub> Increase per Reference Buffer <sup>2</sup>		10	20	μA	All gains
Mid Power Mode					
Gain = 1 <sup>2</sup>		150	170	μA	All buffers off
Gain = 1 I <sub>AVDD</sub> Increase per AINx Buffer <sup>2</sup>		30	40	μA	
Gain = 2 to 8		275	345	μA	
Gain = 16 to 128		330	430	μA	
I <sub>AVDD</sub> Increase per Reference Buffer <sup>2</sup>		20	30	μA	All gains
Full Power Mode					
Gain = 1 <sup>2</sup>		315	350	μA	All buffers off
Gain = 1 I <sub>AVDD</sub> Increase per AINx Buffer <sup>2</sup>		90	135	μA	
Gain = 2 to 8		660	830	μA	
Gain = 16 to 128		875	1200	μA	
I <sub>AVDD</sub> Increase per Reference Buffer <sup>2</sup>		85	120	μA	All gains
I <sub>AVDD</sub> Increase					
Due to Internal Reference <sup>2</sup>		50	70	μA	Independent of power mode; the reference buffers are not required when using this reference
Due to V <sub>BIAS</sub> <sup>2</sup>		15	20	μA	Independent of power mode
Due to Diagnostics <sup>2</sup>		4	5	μA	
I <sub>IOVDD</sub>					
Low Power Mode		20	35	μA	
Mid Power Mode		25	40	μA	
Full Power Mode		55	80	μA	



Parameter <sup>1</sup>	Min	Typ	Max	Unit	Test Conditions/Comments
POWER-DOWN CURRENTS <sup>13</sup>					Independent of power mode
Standby Current					
I <sub>AVDD</sub>		7	15	μA	LDOs on only
I <sub>IOVDD</sub>		8	20	μA	
Power-Down Current					
I <sub>AVDD</sub>		1	3	μA	
I <sub>IOVDD</sub>		1	2	μA	

<sup>1</sup> Temperature range = -55°C to +125°C.

<sup>2</sup> These specifications are not production tested but are supported by characterization data at the initial product release.

<sup>3</sup> FS is the decimal equivalent of the FS[10:0] bits in the filter registers.

<sup>4</sup> The integral nonlinearity is production tested in full power mode only. For other power modes, the specification is supported by characterization data at the initial product release.

<sup>5</sup> Following a system or internal zero-scale calibration, the offset error is in the order of the noise for the programmed gain and output data rate selected. A system full-scale calibration reduces the gain error to the order of the noise for the programmed gain and output data rate.

<sup>6</sup> Recalibration at any temperature removes these errors.

<sup>7</sup> Gain error applies to both positive and negative full-scale. A factory calibration is performed at gain = 1, T<sub>A</sub> = 25°C.

<sup>8</sup> When gain > 1, the common-mode voltage is between (AV<sub>SS</sub> + 0.1 + 0.5/gain) and (AV<sub>DD</sub> - 0.1 - 0.5/gain).

<sup>9</sup> Specification is for a wider common-mode voltage between (AV<sub>SS</sub> - 0.05 + 0.5/gain) and (AV<sub>DD</sub> - 0.1 - 0.5/gain).

<sup>10</sup> REJ60 is a bit in the filter registers. When the first notch of the sinc filter is at 50 Hz, a notch is placed at 60 Hz when REJ60 is set to 1. This gives simultaneous 50 Hz and 60 Hz rejection.

<sup>11</sup> When the gain is greater than 1, the analog input buffers are enabled automatically. The buffers can only be disabled when the gain equals 1.

<sup>12</sup> When V<sub>REF</sub> = (AV<sub>DD</sub> - AV<sub>SS</sub>), the typical differential input equals 0.92 × V<sub>REF</sub>/gain for the low and mid power modes and 0.86 × V<sub>REF</sub>/gain for full power mode when gain > 1.

<sup>13</sup> The digital inputs are equal to IOV<sub>DD</sub> or DGND with excitation currents and bias voltage generator disabled.

## ABSOLUTE MAXIMUM RATINGS

$T_A = 25^\circ\text{C}$ , unless otherwise noted.

Table 2.

Parameter	Rating
$AV_{DD}$ to $AV_{SS}$	-0.3 V to +3.96 V
$IOV_{DD}$ to DGND	-0.3 V to +3.96 V
$IOV_{DD}$ to $AV_{SS}$	-0.3 V to +5.94 V
$AV_{SS}$ to DGND	-1.98 V to +0.3 V
Analog Input Voltage to $AV_{SS}$	-0.3 V to $AV_{DD} + 0.3$ V
Reference Input Voltage to $AV_{SS}$	-0.3 V to $AV_{DD} + 0.3$ V
Digital Input Voltage to DGND	-0.3 V to $IOV_{DD} + 0.3$ V
Digital Output Voltage to DGND	-0.3 V to $IOV_{DD} + 0.3$ V
AINx/Digital Input Current	10 mA
Operating Temperature Range	$-55^\circ\text{C}$ to $+125^\circ\text{C}$
Storage Temperature Range	$-65^\circ\text{C}$ to $+150^\circ\text{C}$
Maximum Junction Temperature	$150^\circ\text{C}$
Lead Temperature, Soldering	
Reflow	$260^\circ\text{C}$
ESD Ratings	
Human Body Model (HBM)	4 kV
Field-Induced Charged Device Model (FICDM)	1250 V
Machine Model	400 V

Stresses at or above those listed under Absolute Maximum Ratings may cause permanent damage to the product. This is a stress rating only; functional operation of the product at these or any other conditions above those indicated in the operational section of this specification is not implied. Operation beyond the maximum operating conditions for extended periods may affect product reliability.

## THERMAL RESISTANCE

Thermal performance is directly linked to printed circuit board (PCB) design and operating environment. Careful attention to PCB thermal design is required.

$\theta_{JA}$  is the natural convection, junction to ambient thermal resistance measured in a one cubic foot sealed enclosure.

$\theta_{JC}$  is the junction to case thermal resistance.

Table 3. Thermal Resistance

Package Type <sup>1</sup>	$\theta_{JA}$	$\theta_{JC}$	Unit
RU-24	128	42	$^\circ\text{C}/\text{W}$

<sup>1</sup> Thermal impedance simulated values are based on a JEDEC 2S2P thermal test board. See JEDEC JESD51.

## ESD CAUTION



**ESD (electrostatic discharge) sensitive device.** Charged devices and circuit boards can discharge without detection. Although this product features patented or proprietary protection circuitry, damage may occur on devices subjected to high energy ESD. Therefore, proper ESD precautions should be taken to avoid performance degradation or loss of functionality.

## PIN CONFIGURATION AND FUNCTION DESCRIPTIONS

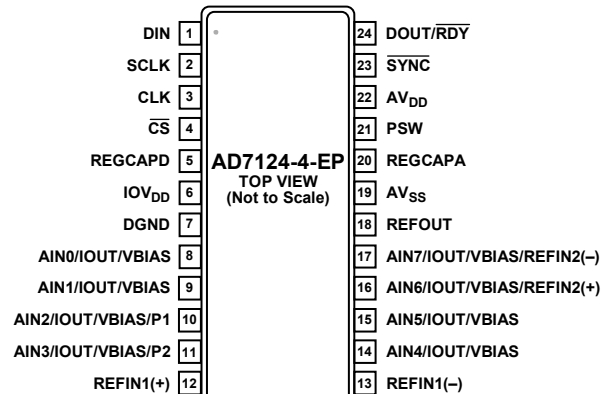

Figure 2. Pin Configuration

Table 4. Pin Function Descriptions

Pin No.	Mnemonic	Description
1	DIN	Serial Data Input to the Input Shift Register on the ADC. Data in the input shift register is transferred to the control registers within the ADC, with the register selection bits of the communications register identifying the appropriate register.
2	SCLK	Serial Clock Input. This serial clock input is for data transfers to and from the ADC. The SCLK pin has a Schmitt-triggered input, making the interface suitable for opto-isolated applications. The serial clock can be continuous with all data transmitted in a continuous train of pulses. Alternatively, it can be a noncontinuous clock with the information being transmitted to or from the ADC in smaller batches of data.
3	CLK	Clock Input/Clock Output. The internal clock can be made available at this pin. Alternatively, the internal clock can be disabled, and the ADC can be driven by an external clock. This allows several ADCs to be driven from a common clock, allowing simultaneous conversions to be performed.
4	$\overline{\text{CS}}$	Chip Select Input. This is an active low logic input that selects the ADC. Use $\overline{\text{CS}}$ to select the ADC in systems with more than one device on the serial bus or as a frame synchronization signal in communicating with the device. $\overline{\text{CS}}$ can be hardwired low if the serial peripheral interface (SPI) diagnostics are unused, allowing the ADC to operate in 3-wire mode with SCLK, DIN, and DOUT interfacing with the device.
5	REGCAPD	Digital LDO Regulator Output. Decouple this pin to DGND with a 0.1 $\mu\text{F}$ capacitor.
6	IOV <sub>DD</sub>	Serial Interface Supply Voltage, 1.65 V to 3.6 V. IOV <sub>DD</sub> is independent of AV <sub>DD</sub> . Therefore, the serial interface can operate at 1.65 V with AV <sub>DD</sub> at 3.6 V, for example.
7	DGND	Digital Ground Reference Point.
8	AIN0/IOUT/VBIAS	Analog Input 0/Output of Internal Excitation Current Source/Bias Voltage. This input pin is configured via the configuration registers to be the positive or negative terminal of a differential or pseudo differential input. Alternatively, the internal programmable excitation current source can be made available at this pin. Either IOUT0 or IOUT1 can be switched to this output. A bias voltage midway between the analog power supply rails can be generated at this pin.
9	AIN1/IOUT/VBIAS	Analog Input 1/Output of Internal Excitation Current Source/Bias Voltage. This input pin is configured via the configuration registers to be the positive or negative terminal of a differential or pseudo differential input. Alternatively, the internal programmable excitation current source can be made available at this pin. Either IOUT0 or IOUT1 can be switched to this output. A bias voltage midway between the analog power supply rails can be generated at this pin.
10	AIN2/IOUT/VBIAS/P1	Analog Input 2/Output of Internal Excitation Current Source/Bias Voltage/General-Purpose Output 1. This input pin is configured via the configuration registers to be the positive or negative terminal of a differential or pseudo differential input. Alternatively, the internal programmable excitation current source can be made available at this pin. Either IOUT0 or IOUT1 can be switched to this output. A bias voltage midway between the analog power supply rails can be generated at this pin. This pin can also be configured as a general-purpose output bit, referenced between AV <sub>SS</sub> and AV <sub>DD</sub> .

Pin No.	Mnemonic	Description
11	AIN3/IOUT/VBIAS/P2	Analog Input 3/Output of Internal Excitation Current Source/Bias Voltage/General-Purpose Output 2. This input pin is configured via the configuration registers to be the positive or negative terminal of a differential or pseudo differential input. Alternatively, the internal programmable excitation current source can be made available at this pin. Either IOUT0 or IOUT1 can be switched to this output. A bias voltage midway between the analog power supply rails can be generated at this pin. This pin can also be configured as a general-purpose output bit, referenced between $AV_{SS}$ and $AV_{DD}$ .
12	REFIN1(+)	Positive Reference Input. An external reference can be applied between REFIN1(+) and REFIN1(-). REFIN1(+) can be anywhere between $AV_{DD}$ and $AV_{SS} + 0.5$ V. The nominal reference voltage (REFIN1(+) – REFIN1(-)) is 2.5 V, but the device functions with a reference from 0.5 V to $AV_{DD}$ .
13	REFIN1(-)	Negative Reference Input. This reference input can be anywhere between $AV_{SS}$ and $AV_{DD} - 0.5$ V.
14	AIN4/IOUT/VBIAS	Analog Input 4/Output of Internal Excitation Current Source/Bias Voltage. This input pin is configured via the configuration registers to be the positive or negative terminal of a differential or pseudo differential input. Alternatively, the internal programmable excitation current source can be made available at this pin. Either IOUT0 or IOUT1 can be switched to this output. A bias voltage midway between the analog power supply rails can be generated at this pin.
15	AIN5/IOUT/VBIAS	Analog Input 5/Output of Internal Excitation Current Source/Bias Voltage. This input pin is configured via the configuration registers to be the positive or negative terminal of a differential or pseudo differential input. Alternatively, the internal programmable excitation current source can be made available at this pin. Either IOUT0 or IOUT1 can be switched to this output. A bias voltage midway between the analog power supply rails can be generated at this pin.
16	AIN6/IOUT/VBIAS/ REFIN2(+)	Analog Input 6/Output of Internal Excitation Current Source/Bias Voltage/Positive Reference Input. This input pin is configured via the configuration registers to be the positive or negative terminal of a differential or pseudo differential input. Alternatively, the internal programmable excitation current source can be made available at this pin. Either IOUT0 or IOUT1 can be switched to this output. A bias voltage midway between the analog power supply rails can be generated at this pin. This pin also functions as a positive reference input for REFIN2( $\pm$ ). REFIN2(+) can be anywhere between $AV_{DD}$ and $AV_{SS} + 0.5$ V. The nominal reference voltage (REFIN2(+) to REFIN2(-)) is 2.5 V, but the device functions with a reference from 0.5 V to $AV_{DD}$ .
17	AIN7/IOUT/VBIAS/ REFIN2(-)	Analog Input 7/Output of Internal Excitation Current Source/Bias Voltage/Negative Reference Input. This input pin is configured via the configuration registers to be the positive or negative terminal of a differential or pseudo differential input. Alternatively, the internal programmable excitation current source can be made available at this pin. Either IOUT0 or IOUT1 can be switched to this output. A bias voltage midway between the analog power supply rails can be generated at this pin. This pin also functions as the negative reference input for REFIN2( $\pm$ ). This reference input can be anywhere between $AV_{SS}$ and $AV_{DD} - 0.5$ V.
18	REFOUT	Internal Reference Output. The buffered output of the internal 2.5 V voltage reference is available on this pin.
19	$AV_{SS}$	Analog Supply Voltage. The voltage on $AV_{DD}$ is referenced to $AV_{SS}$ . The differential between $AV_{DD}$ and $AV_{SS}$ must be between 2.7 V and 3.6 V in mid or low power mode and between 2.9 V and 3.6 V in full power mode. $AV_{SS}$ can be taken below 0 V to provide a dual power supply to the AD7124-4-EP. For example, $AV_{SS}$ can be tied to -1.8 V and $AV_{DD}$ can be tied to +1.8 V, providing a $\pm 1.8$ V supply to the ADC.
20	REGCAPA	Analog LDO Regulator Output. Decouple this pin to $AV_{SS}$ with a 0.1 $\mu$ F capacitor.
21	PSW	Low-Side Power Switch to $AV_{SS}$ .
22	$AV_{DD}$	Analog Supply Voltage, Relative to $AV_{SS}$ .
23	$\overline{SYNC}$	Synchronization Input. This pin is a logic input that allows synchronization of the digital filters and analog modulators when using a number of AD7124-4-EP devices. When $\overline{SYNC}$ is low, the nodes of the digital filter, the filter control logic, and the calibration control logic are reset, and the analog modulator is held in a reset state. $\overline{SYNC}$ does not affect the digital interface but does reset RDY to a high state if it is low.
24	DOUT/ $\overline{RDY}$	Serial Data Output/Data Ready Output. DOUT/ $\overline{RDY}$ functions as a serial data output pin to access the output shift register of the ADC. The output shift register can contain data from any of the on-chip data or control registers. In addition, DOUT/ $\overline{RDY}$ operates as a data ready pin, going low to indicate the completion of a conversion. If the data is not read after the conversion, the pin goes high before the next update occurs. The DOUT/ $\overline{RDY}$ falling edge can also be used as an interrupt to a processor, indicating that valid data is available. With an external serial clock, the data can be read using the DOUT/ $\overline{RDY}$ pin. When $\overline{CS}$ is low, the data/control word information is placed on the DOUT/ $\overline{RDY}$ pin on the SCLK falling edge and is valid on the SCLK rising edge.

### TYPICAL PERFORMANCE CHARACTERISTICS

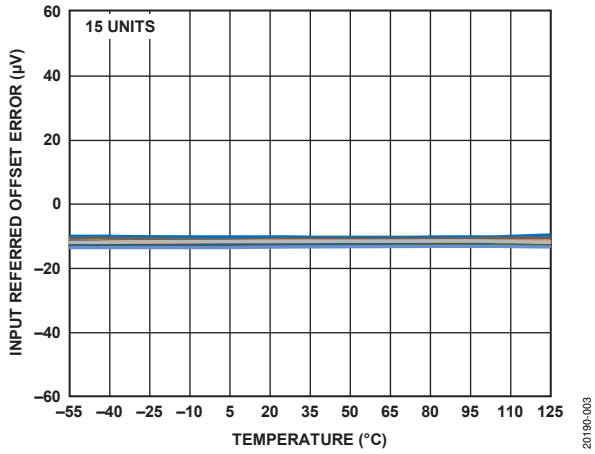

Figure 3. Input Referred Offset Error vs. Temperature (Gain = 8, Full Power Mode)

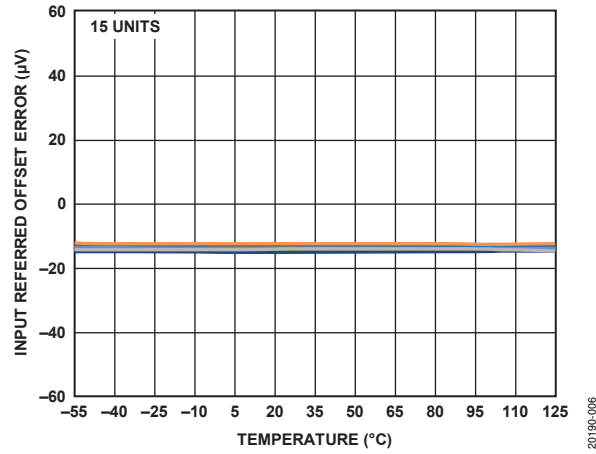

Figure 6. Input Referred Offset Error vs. Temperature (Gain = 16, Full Power Mode)

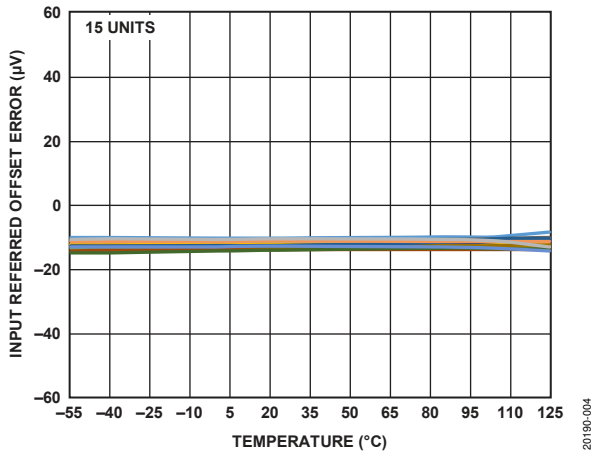

Figure 4. Input Referred Offset Error vs. Temperature (Gain = 8, Mid Power Mode)

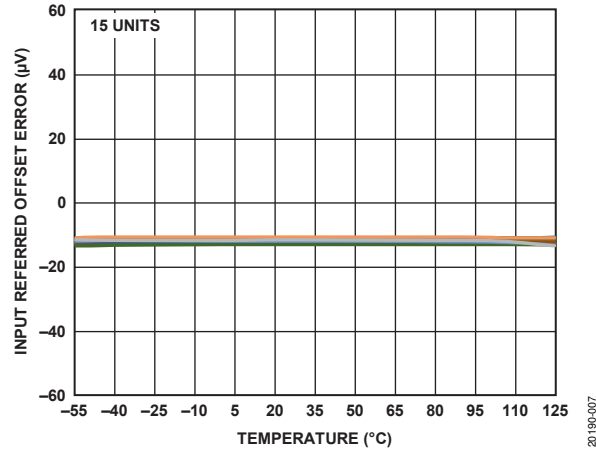

Figure 7. Input Referred Offset Error vs. Temperature (Gain = 16, Mid Power Mode)

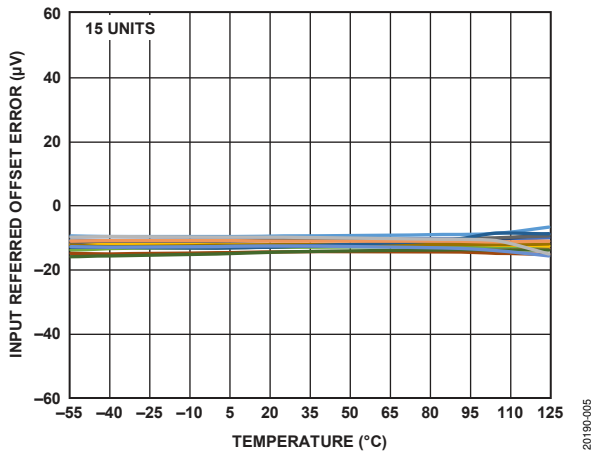

Figure 5. Input Referred Offset Error vs. Temperature (Gain = 8, Low Power Mode)

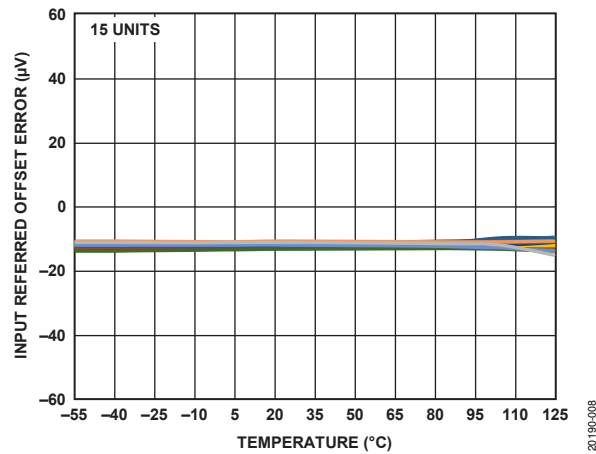

Figure 8. Input Referred Offset Error vs. Temperature (Gain = 16, Low Power Mode)

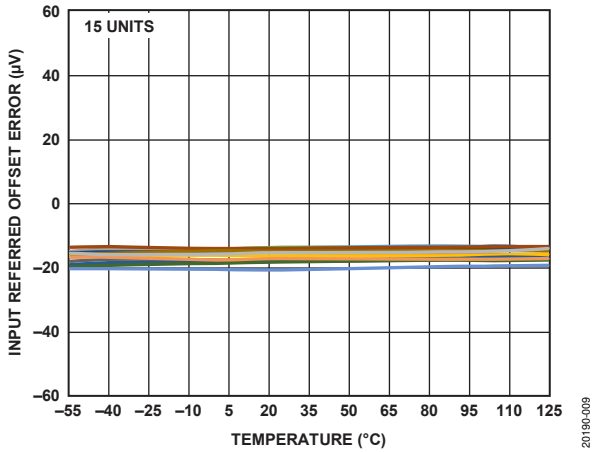

Figure 9. Input Referred Offset Error vs. Temperature (Gain = 1, Analog Input Buffers Enabled)

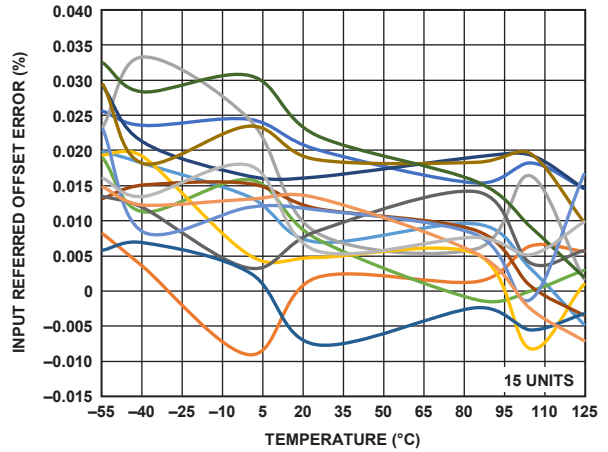

Figure 12. Input Referred Gain Error vs. Temperature (Gain = 16)

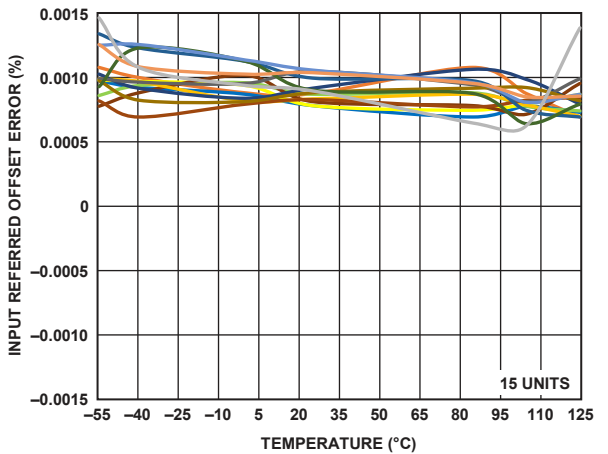

Figure 10. Input Referred Gain Error vs. Temperature (Gain = 1)

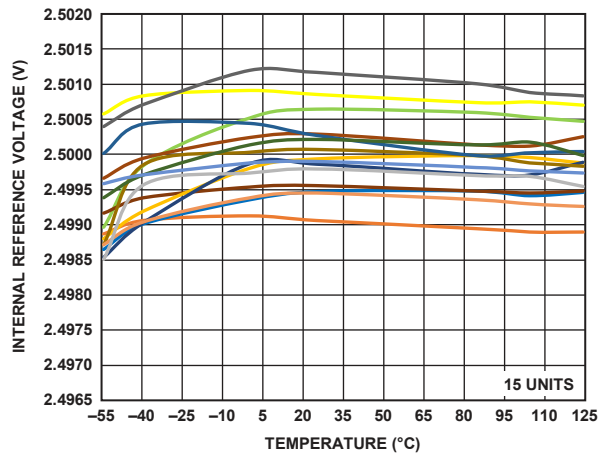

Figure 13. Internal Reference Voltage vs. Temperature

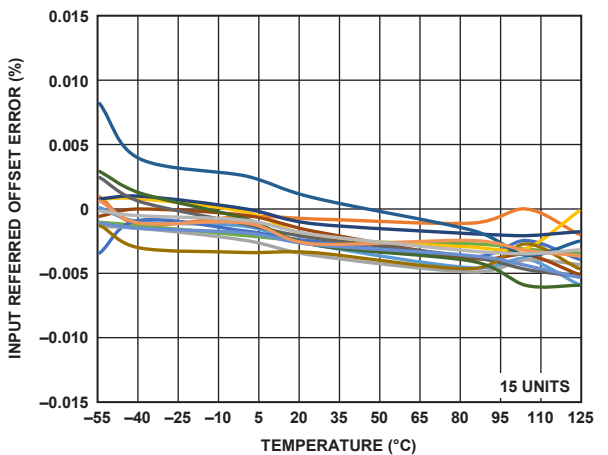

Figure 11. Input Referred Gain Error vs. Temperature (Gain = 8)

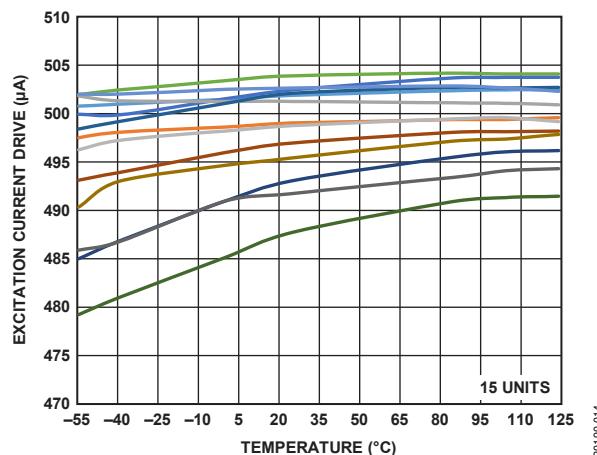

Figure 14. Excitation Current Drift (500 µA)

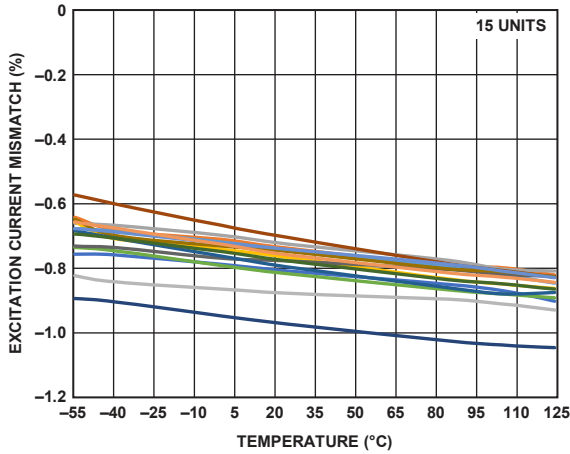

Figure 15. Excitation Current Drift Matching (500 μA)

20190-015

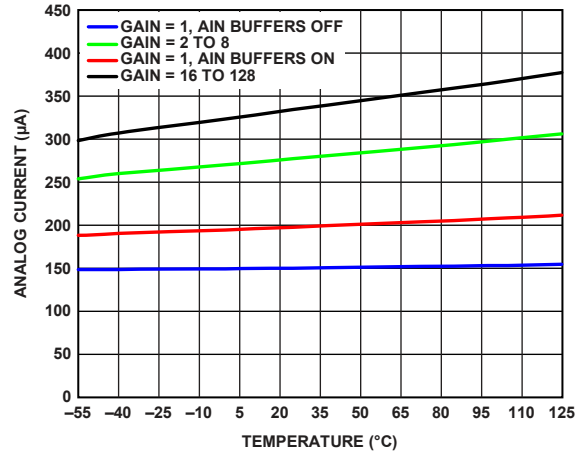

Figure 17. Analog Current vs. Temperature (Mid Power Mode)

20190-017

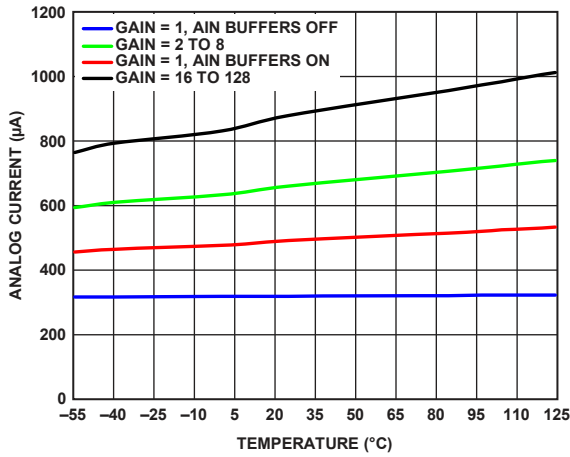

Figure 16. Analog Current vs. Temperature (Full Power Mode)

20190-016

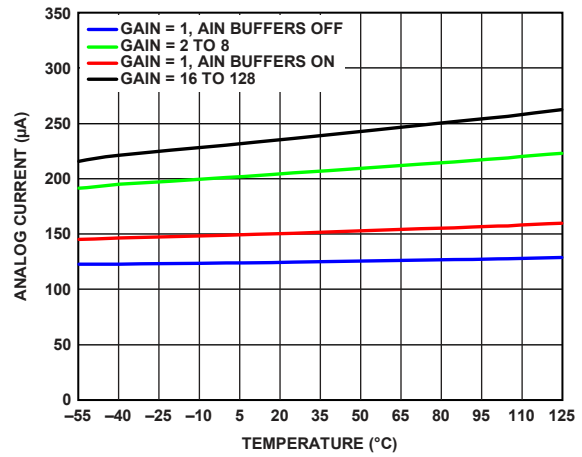

Figure 18. Analog Current vs. Temperature (Low Power Mode)

20190-018

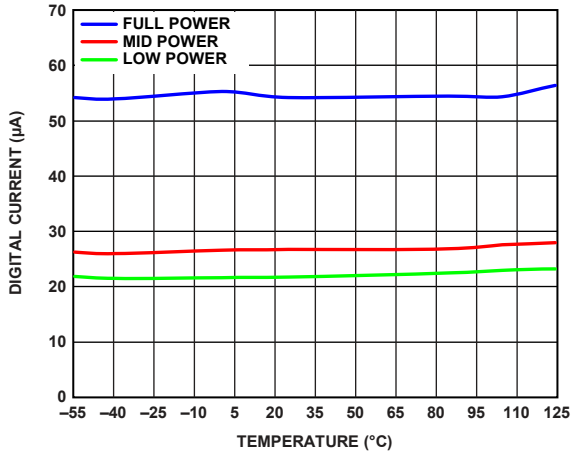

Figure 19. Digital Current vs. Temperature

20190-019

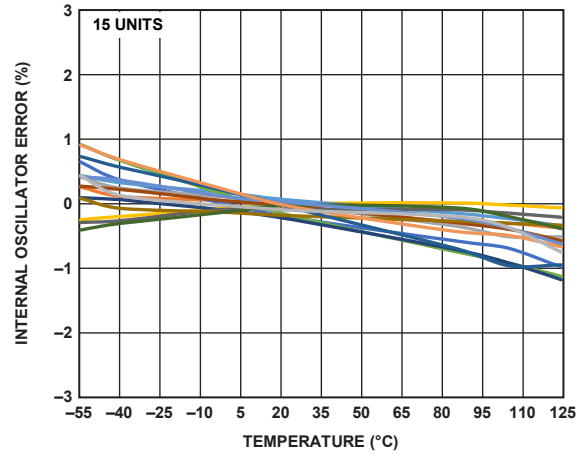

Figure 21. Internal Oscillator Error vs. Temperature

20190-028

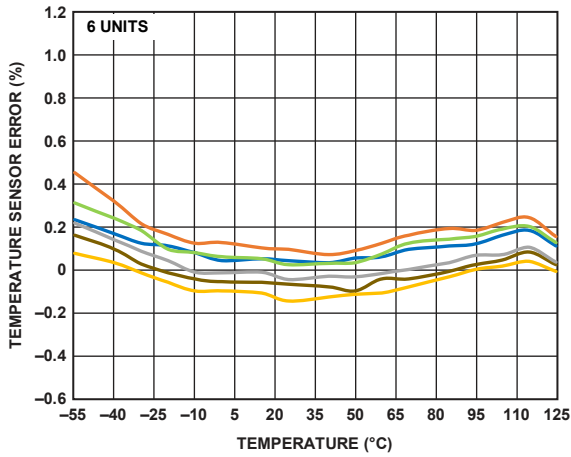
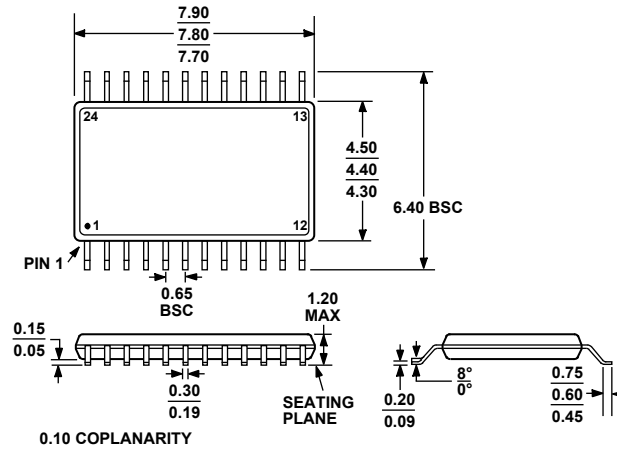

Figure 20. Temperature Sensor Accuracy

20190-027



### OUTLINE DIMENSIONS



COMPLIANT TO JEDEC STANDARDS MO-153-AD

Figure 22. 24-Lead Thin Shrink Small Outline Package [TSSOP] (RU-24)

Dimensions shown in millimeters

### ORDERING GUIDE

Model <sup>1</sup>	Temperature Range	Package Description	Package Option
AD7124-4TRUZ-EP	-55°C to +125°C	24-Lead Thin Shrink Small Outline Package [TSSOP]	RU-24
AD7124-4TRUZ-EP-R7	-55°C to +125°C	24-Lead Thin Shrink Small Outline Package [TSSOP]	RU-24

<sup>1</sup> Z = RoHS Compliant Part.