

Features

- Guard Ring Protection
- Low Power Loss For High Efficiency
- Lead Free Finish/RoHS Compliant(Note 1)("P" Suffix Designates Compliant. See Ordering Information)
- Epoxy Meets UL 94 V-0 Flammability Rating
- Halogen Free Available Upon Request By Adding Suffix "-HF"

Maximum Ratings

- Operating Junction Temperature Range: -55°C to +125°C
- Storage Temperature Range: -55°C to +125°C
- Maximum Thermal Resistance: 30°C/W Junction To Lead

MCC Part Number	Device Marking	Maximum Recurrent Peak Reverse Voltage	Maximum RMS Voltage	Maximum DC Blocking Voltage
SR105	SR105	50V	35V	50V
SR106	SR106	60V	42V	60V
SR108	SR108	80V	56V	80V
SR1010	SR1010	100V	70V	100V

Electrical Characteristics @ 25°C Unless Otherwise Specified

Average Forward Current	$I_{F(AV)}$	1.0A	$T_A = 75^\circ\text{C}$
Peak Forward Surge Current	I_{FSM}	30A	8.3ms, Half Sine
Maximum Instantaneous Forward Voltage	V_F	SR105-SR106 0.70V SR108-SR1010 0.85V	$I_{FM}=1.0A$; $T_J=25^\circ\text{C}^*$
Maximum DC Reverse Current at Rated DC Blocking Voltage	I_R	0.1mA 10mA	$T_J=25^\circ\text{C}$; $T_J=100^\circ\text{C}$

*Pulse test: Pulse width 300 μsec , Duty cycle 2%

Note : 1.High Temperature Solder Exemption Applied, See EU Directive Annex 7a.

1.0 Amp Schottky Barrier Rectifier 50 to 100 Volts

DO-41

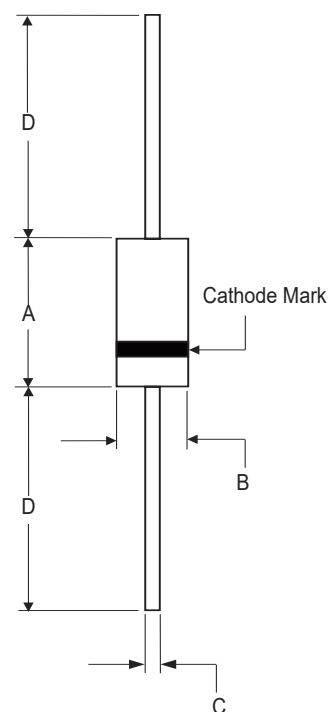

DIM	DIMENSIONS				NOTE
	INCHES		MM		
	MIN	MAX	MIN	MAX	
A	0.160	0.205	4.10	5.20	
B	0.080	0.107	2.00	2.70	Φ
C	0.028	0.035	0.71	0.90	Φ
D	1.000	-----	25.40	-----	

Curve Characteristics

Fig. 1 - Forward Current Derating Curve

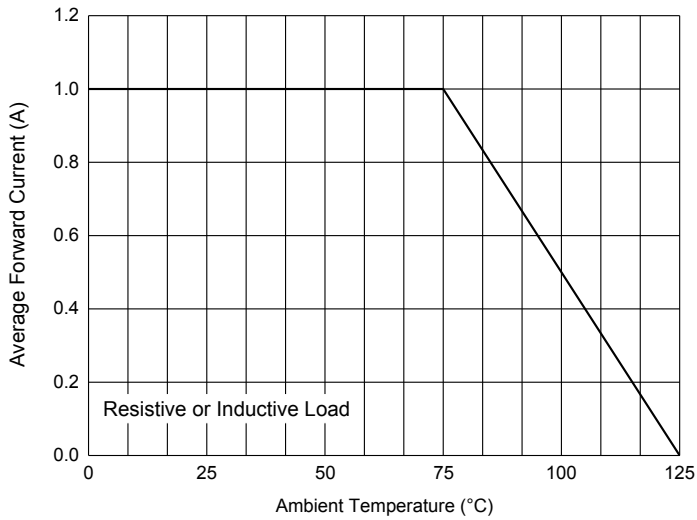

Fig. 2 - Maximum Non-Repetitive Peak Forward Surge Current

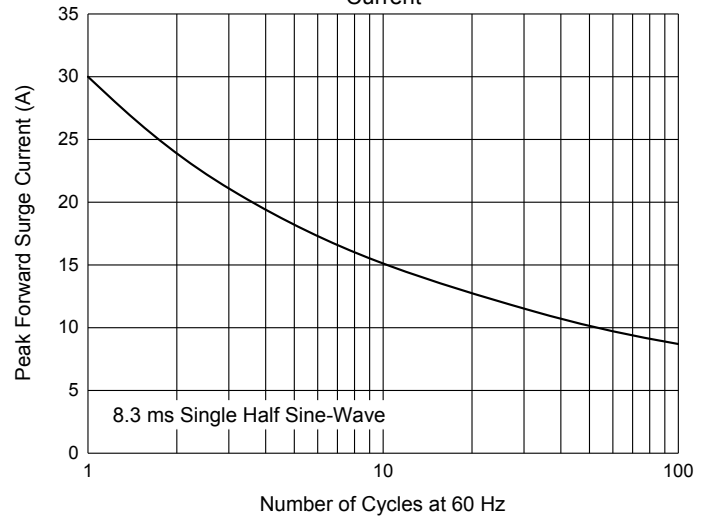

Fig. 3 - Typical Instantaneous Forward Characteristics

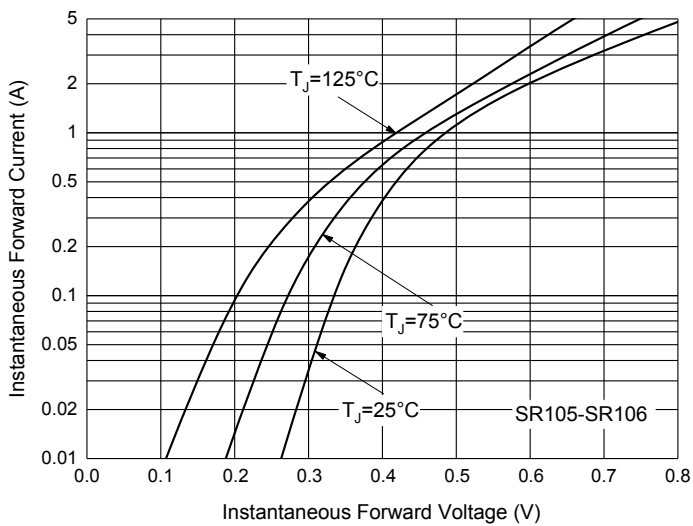

Fig. 4 - Typical Instantaneous Forward Characteristics

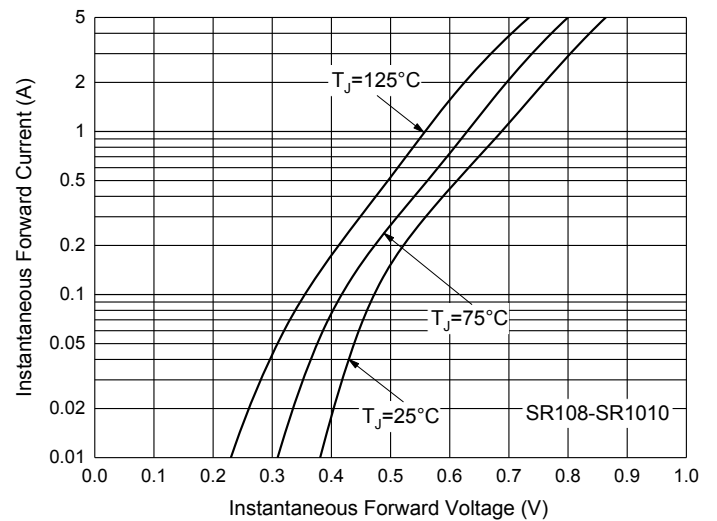

Fig. 5 - Typical Reverse Leakage Characteristics

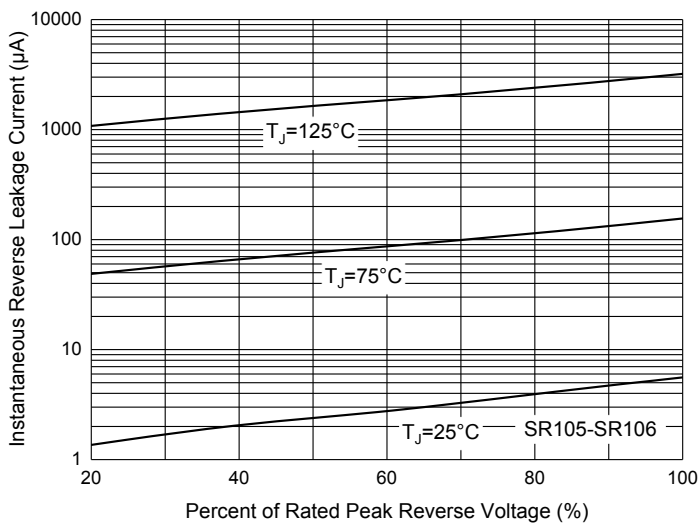
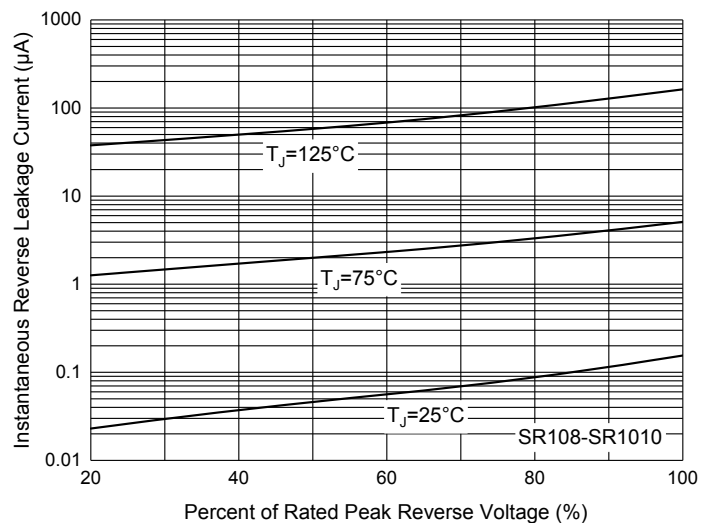

Fig. 6 - Typical Reverse Leakage Characteristics



Ordering Information

Device	Packing
(Part Number)-TP	Tape&Reel: 5Kpcs/Reel
(Part Number)-AP	Ammo Packing: 5Kpcs/Ammo Box
(Part Number)-BP	Bulk: 1Kpcs/Box, 50Kpcs/Carton

Note : Adding "-HF" Suffix For Halogen Free, eg. Part Number-TP-HF

IMPORTANT NOTICE

Micro Commercial Components Corp. reserves the right to make changes without further notice to any product herein to make corrections, modifications, enhancements, improvements, or other changes. **Micro Commercial Components Corp.** does not assume any liability arising out of the application or use of any product described herein; neither does it convey any license under its patent rights, nor the rights of others. The user of products in such applications shall assume all risks of such use and will agree to hold **Micro Commercial Components Corp.** and all the companies whose products are represented on our website, harmless against all damages. **Micro Commercial Components Corp.** products are sold subject to the general terms and conditions of commercial sale, as published at <https://www.mccsemi.com/Home/TermsAndConditions>.

LIFE SUPPORT

MCC's products are not authorized for use as critical components in life support devices or systems without the express written approval of Micro Commercial Components Corporation.

CUSTOMER AWARENESS

Counterfeiting of semiconductor parts is a growing problem in the industry. Micro Commercial Components (MCC) is taking strong measures to protect ourselves and our customers from the proliferation of counterfeit parts. MCC strongly encourages customers to purchase MCC parts either directly from MCC or from Authorized MCC Distributors who are listed by country on our web page cited below. Products customers buy either from MCC directly or from Authorized MCC Distributors are genuine parts, have full traceability, meet MCC's quality standards for handling and storage. **MCC will not provide any warranty coverage or other assistance for parts bought from Unauthorized Sources.** MCC is committed to combat this global problem and encourage our customers to do their part in stopping this practice by buying direct or from authorized distributors.