

RECOMMENDED PCB LAYOUT
(TOLERANCE : ±0.05)

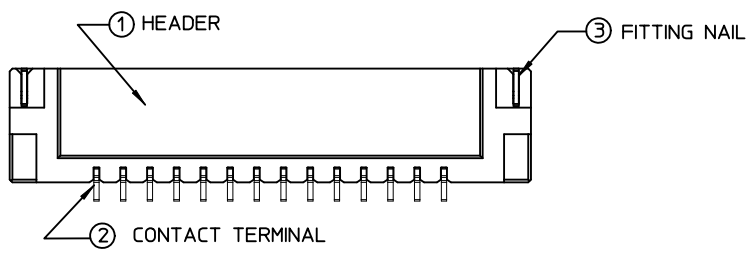

NOTES.

1. MATED WITH : 104138-1400
2. MATERIALS.
 - ① HEADER : LIQUID CRYSTAL POLYMER, COLOR OF NATURAL
 - ② CONTACT TERMINAL : PHOSPHOR BRONZE
 - ③ FITTING NAIL : PHOSPHOR BRONZE
3. FINESHIES.
 - ② CONTACT TERMINAL : PURE-TIN OVER NI PLATING
 - ③ FITTING NAIL : PURE-TIN OVER NIPLATING
4. COPLANALITH OF SOLDER TAIL (PEAK TEMP. : 260°C) BEFORE & AFTER REFLOW : 0.08MAX

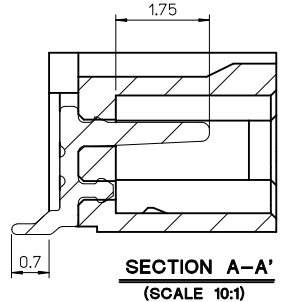
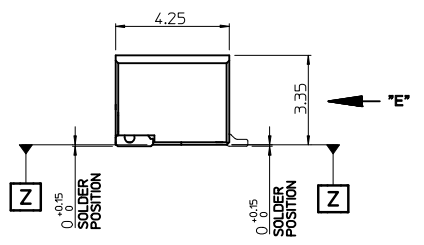
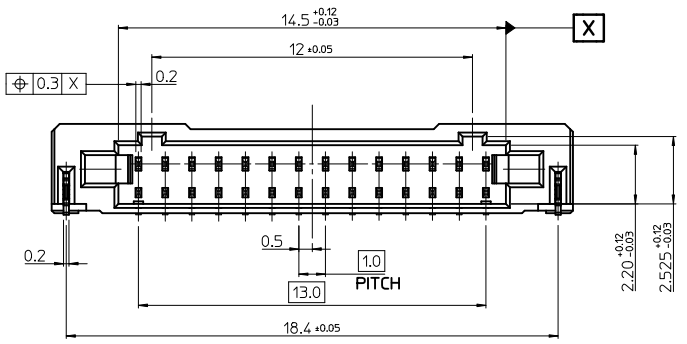
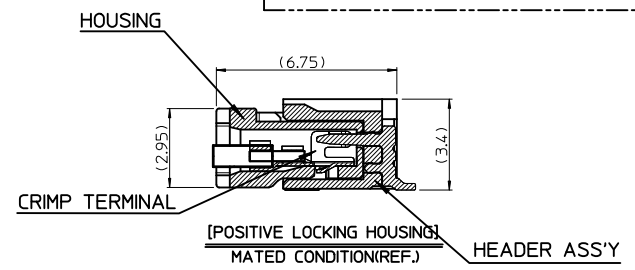
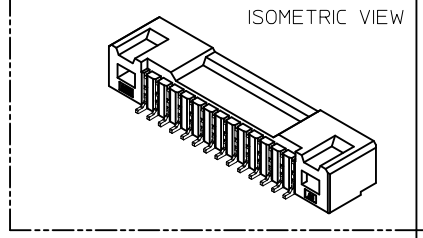
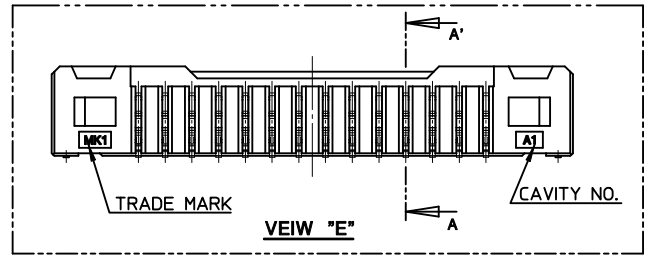

NEW RELEASED EC NO: KOR2012-0112 DRWN:HYOU CHKD:SH. CHU APPR:YSK1M02	2012/04/21 2012/04/25	QUALITY SYMBOLS ▽=0 ◻=0	GENERAL TOLERANCES (UNLESS SPECIFIED)		DIMENSION STYLE MM ONLY		SCALE 5:1	DESIGN UNITS METRIC	THIRD ANGLE PROJECTION		
			4 PLACES	± ---	± ---	DRAWN BY I.H. YOU	DATE 2011/04/19	TITLE 1.0 W-T-B CONN.-14P HEADER ASS'Y			
			3 PLACES	± ---	± ---	CHECKED BY SH. CHU	DATE 2011/04/19				
			2 PLACES	± 0.15	± ---	APPROVED BY YSK1M02	DATE 2012/04/25	MATERIAL NO. 1041391410		MOLEX INCORPORATED	
1 PLACE	± 0.20	± ---	ANGULAR ± 1 °		DRAFT WHERE APPLICABLE MUST REMAIN WITHIN DIMENSIONS		DOCUMENT NO. SD-104139-001		SHEET NO. 1 OF 1		
SIZE A3			THIS DRAWING CONTAINS INFORMATION THAT IS PROPRIETARY TO MOLEX INCORPORATED AND SHOULD NOT BE USED WITHOUT WRITTEN PERMISSION								

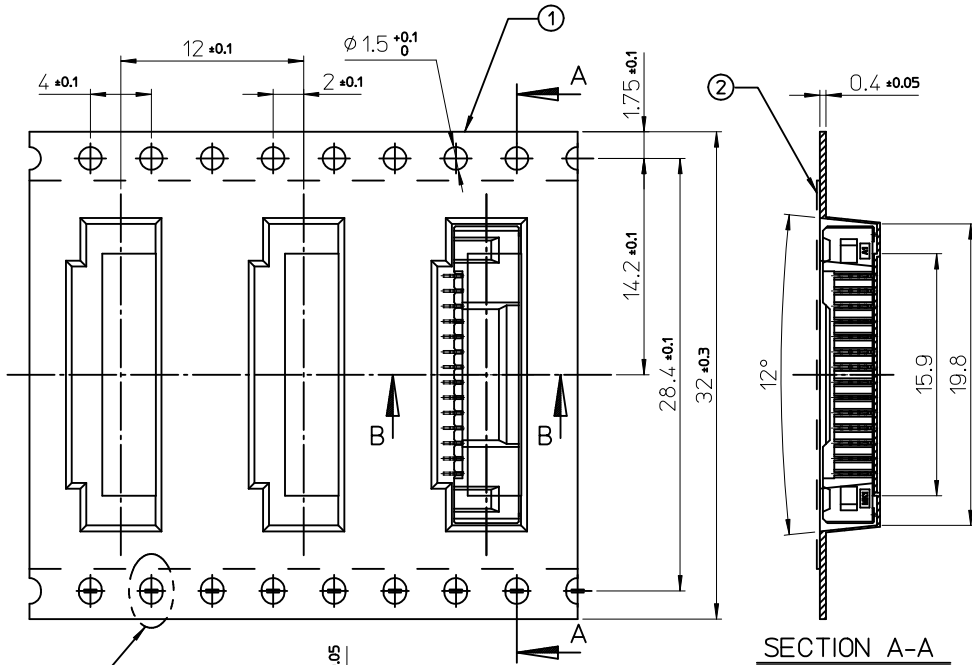

SECTION A-A

PULL OUT DIRECTION

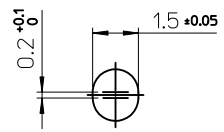

DETAIL C

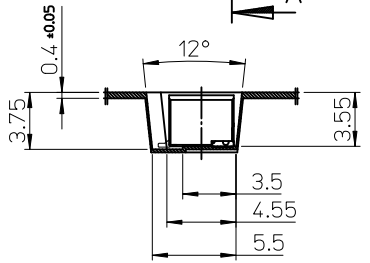

SECTION B-B

PULL OUT DIRECTION

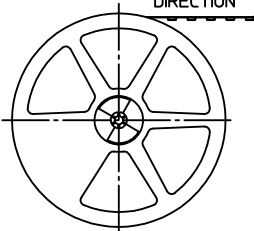

PLASTIC BOBBIN

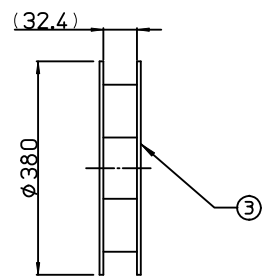

NOTES

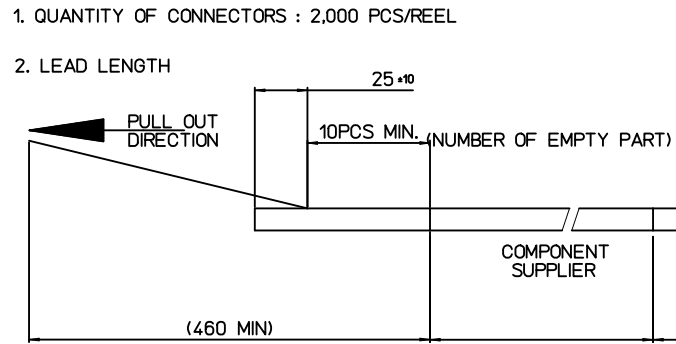

1. QUANTITY OF CONNECTORS : 2,000 PCS/REEL
 2. LEAD LENGTH
 3. PEELING OFF FORCE OF COVER TAPE : 0.1N~0.59N(10.2GF~60GF)
 (PEELING DIRECTION AS SHOW IN FOLLOW FIG.)
 PEELING OFF SPEED : 300mm/Min.(Ref.)

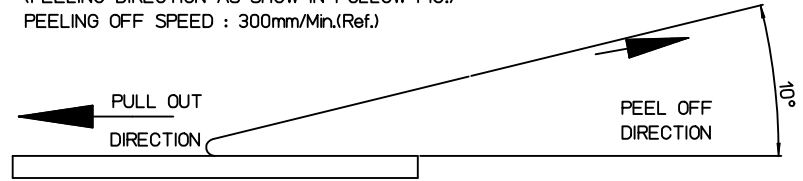

4. FLASH IN ANY PORTION SHOULD BE LESS THAN 0.20mm MAX.
 5. UNLESS OTHERWISE SPECIFIED INNER R0.2 MAX
 6. DRAFT ANGLE 3°MAX

[TABLE]

NO.	DESCRIPTION	MATERIAL	REMARK
3	PLASTIC BOBBIN	HI P.S	WHITE
2	COVER TAPE	PET ANTISTATIC	25.5m
1	CARRIER (EMBOSSD) TAPE	PET ANTISTATIC	

NEW RELEASED EC NO: KOR2012-0112 DRWN: IHYOU CHKD: SH. CHU APPR: YSKIM02 2012/04/21 2012/04/25	QUALITY SYMBOLS ▽=0 ▽=0	GENERAL TOLERANCES (UNLESS SPECIFIED)		DIMENSION STYLE MM ONLY		SCALE 4:1	ORDER NUMBER 104139-1410	
		4 PLACES ± --- ± --- 3 PLACES ± --- ± --- 2 PLACES ± --- ± --- 1 PLACE ± 0.25 ± ---		DRAWN BY IH. YOU		DATE 2011/05/11	DESIGN UNITS METRIC	THIRD ANGLE PROJECTION
		ANGULAR ± 1 °		CHECKED BY SH. CHU		DATE 2011/05/11		
		DRAFT WHERE APPLICABLE MUST REMAIN WITHIN DIMENSIONS		APPROVED BY YSKIM02		DATE 2012/04/25	TITLE 1.0 W-T-B CONN.-14P HEADER ASS'Y EMBOSSD PACKAGE	
REV A		MATERIAL NO. SEE TABLE		MOLEX INCORPORATED		DOCUMENT NO. SD-104139-002	SHEET NO. 1 OF 1	