

ROHM Switching Regulator Solutions

Evaluation Board: Synchronous Buck Converter Integrated FET

BD9B300MUV-E2EVK-101 (3.3V | 3A Output)

No.000000000

• Introduction

This application note will provide the steps necessary to operate and evaluate ROHM's synchronous buck DC/DC converter using the BD9B300MUV evaluation boards. Component selection, board layout recommendations, operation procedures and application data is provided.

• Description

This evaluation board has been developed for ROHM's synchronous buck DC/DC converter customers evaluating BD9B300MUV. While accepting a power supply of 2.7-5.5V, an output of 3.3V can be produced. The IC has internal 35mΩ high-side P-channel MOSFET and 35mΩ low-side N-channel MOSFET and a synchronization frequency is of 1MHz (FREQ pin is connected to V_{IN}) or 2MHz (FREQ pin is connected to ground). A fixed Soft Start circuit prevents in-rush current during startup along with UVLO (Under Voltage Lockout) and TSD (Thermal Shutdown) protection circuits. An EN pin allows for simple ON/OFF control of the IC to reduce standby current consumption. A MODE pin allows the user to select fixed frequency PWM mode or enables the Deep-SLLM control and the mode is automatically switched between the Deep-SLLM control and fixed frequency PWM mode.

• Applications

Step-down Power Supply for DSPs, FPGAs, Microprocessors, etc...
 Laptop PCs/Tablet PCs/Servers
 LCD TVs
 Storage Devices (HDDs/SSDs)
 Printers, OA Equipment
 Entertainment Devices
 Distributed Power Supply, Secondary Power Supply

• Evaluation Board Operating Limits and Absolute Maximum Ratings

Parameter	Symbol	Limit			Unit	Conditions	
		MIN	TYP	MAX			
Supply Voltage							
	BD9B300MUV	V_{CC}	2.7	-	5.5	V	
Output Voltage / Current							
	BD9B300MUV	V_{OUT}	-	3.3	-	V	
		I_{OUT}	-	-	3	A	

• **Evaluation Board**

Below is evaluation board with the BD9B300MUV.



Fig 1: BD9B300MUV Evaluation Board

• **Evaluation Board Schematic**

Below is evaluation board schematic for BD9B300MUV.

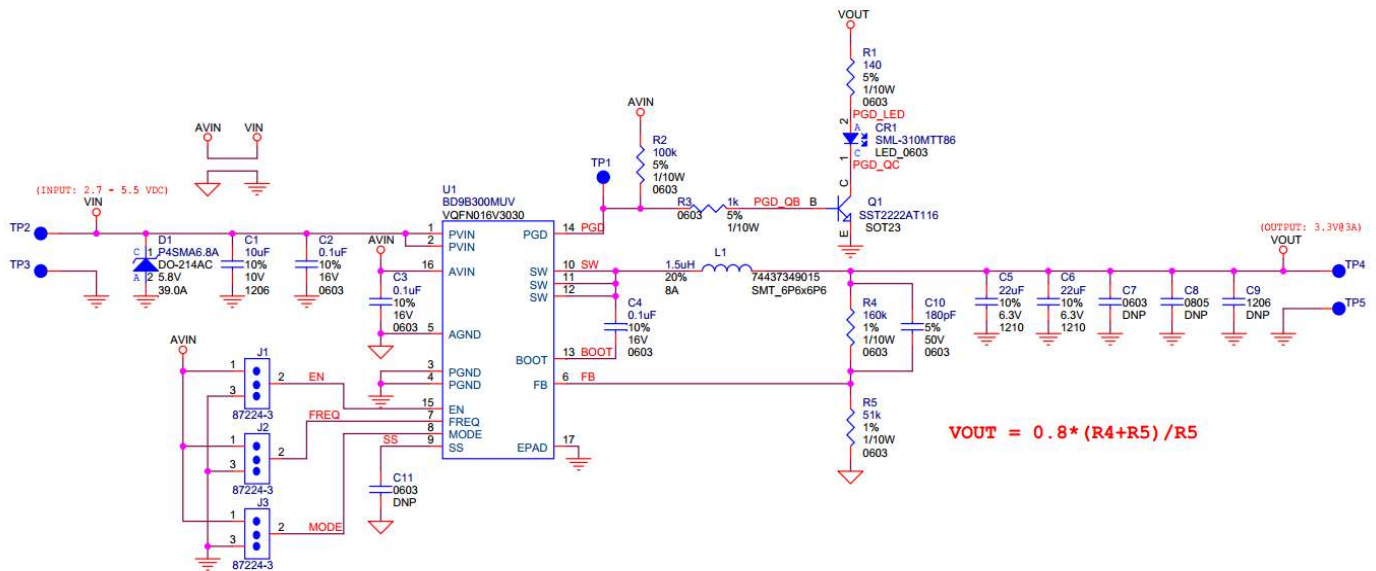

$$V_{OUT} = 0.8 * (R4+R5) / R5$$

Note:

1. $0.8V \leq V_{OUT} \leq 0.8 * V_{IN}$

BD9B300MUV EVM Jumper Positions		
Reference Designator	Position	Description
J1	2 - 1	Enable U1
	2 - 3	Disable U1
J2	2 - 1	Set switching frequency of U1 is 1.0MHz
	2 - 3	Set switching frequency of U1 is 2.0MHz
J3	2 - 1	Set operation mode of U1 is fixed frequency PWM mode
	2 - 3	Set operation mode of U1 is automatically switched between the Deep-SLLM control and fixed frequency PWM mode

Fig 2: BD9B300MUV Evaluation Board Schematic

• Evaluation Board I/O

Below is reference application circuit that shows the inputs (V_{IN} , Enable, FREQ and MODE) and the output (V_{OUT}).

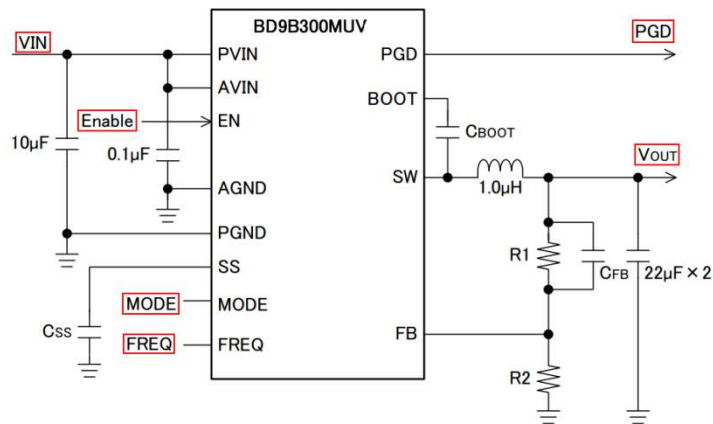

Fig 3: BD9B300MUV Evaluation Board I/O

• Evaluation Board Operation Procedures

Below is the procedure to operate the evaluation board.

1. Connect power supply's GND terminal to GND test point TP3 on the evaluation board.
2. Connect power supply's V_{CC} terminal to V_{IN} test point TP2 on the evaluation board. This will provide V_{IN} to the IC U1. Please note that the V_{CC} should be in range of 2.7V to 5.5V.
3. Set operation mode of IC by set position of shunt jumper of J3 (If Pin2 connect to Pin1, MODE pin of IC U1 will be pulled high and IC U1 will operate in Fixed frequency PWM mode, else MODE pin of IC U1 will be pulled low and IC U1 will operate in Automatically switched between the Deep-SLLM control and fixed frequency PWM mode).
4. Set switching frequency of IC by set position of shunt jumper of J2 (If Pin2 connect to Pin1, Frequency pin of IC U1 will be pulled high and IC U1 will switch frequency of U1 is 1.0MHz, else Frequency pin of IC U1 will be pulled low and IC U1 will switch frequency of U1 is 2.0MHz).
5. Check if shunt jumper of J1 is at position ON (Pin2 connect to Pin1, EN pin of IC U1 is pulled high).
6. Connect electronic load to TP4 and TP5. Do not turn on load.
7. Turn on power supply. The output voltage V_{OUT} (+3.3V) can be measured at the test point TP4. Now turn on the load. The load can be increased up to 3A MAX.

• Reference Application Data for BD9B300MUV-E2EVK-101

Following graphs show hot plugging test, quiescent current, efficiency, load response, output voltage ripple response of the BD9B300MUV evaluation board.

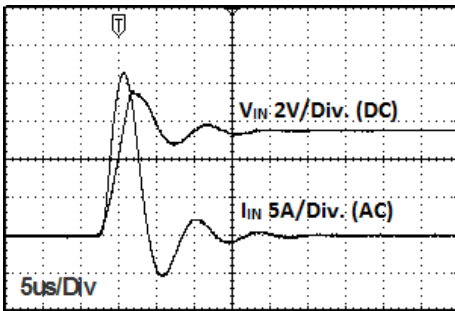

Fig 4: Hot Plug-in Test with Zener Diode P4SMA6.8A, $V_{IN}=5.5V$, $V_{OUT}=3.3V$, $I_{OUT}=3A$, $FREQ=L$, $MODE=L$

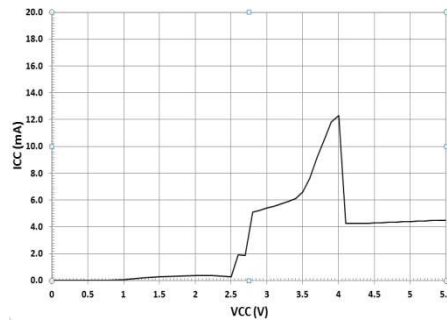

Fig 5: Circuit Current vs. Power supply Voltage Characteristics ($Temp=25^{\circ}C$, $FREQ=L$, $MODE=L$)

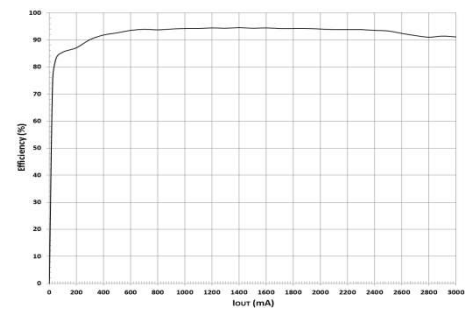

Fig 6: Electric Power Conversion Rate ($V_{OUT}=3.3V$, $FREQ=L$, $MODE=L$)

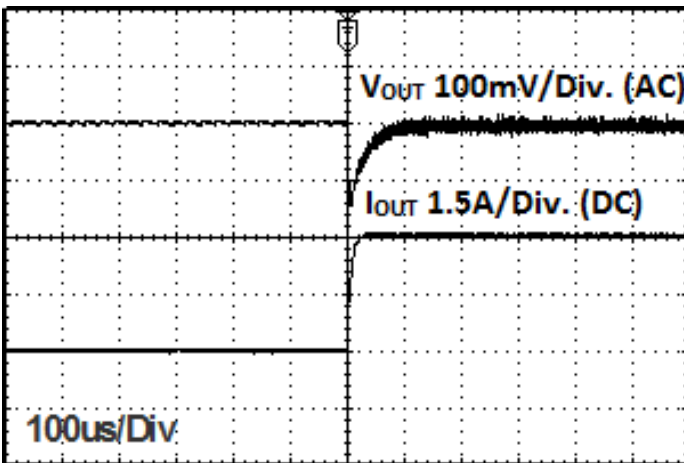

Fig 7: Load Response Characteristics ($V_{IN}=5V$, $V_{OUT}=3.3V$, $I_{OUT}=0 \rightarrow 3A$, $FREQ=L$, $MODE=L$)

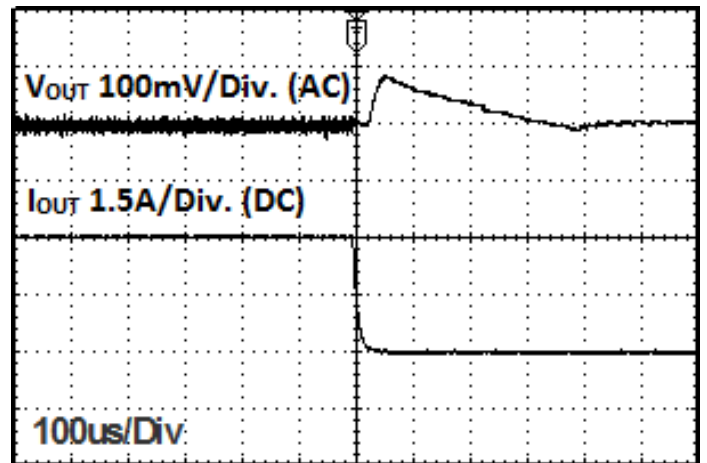

Fig 8: Load Response Characteristics ($V_{IN}=5V$, $V_{OUT}=3.3V$, $I_{OUT}=3A \rightarrow 0$, $FREQ=L$, $MODE=L$)

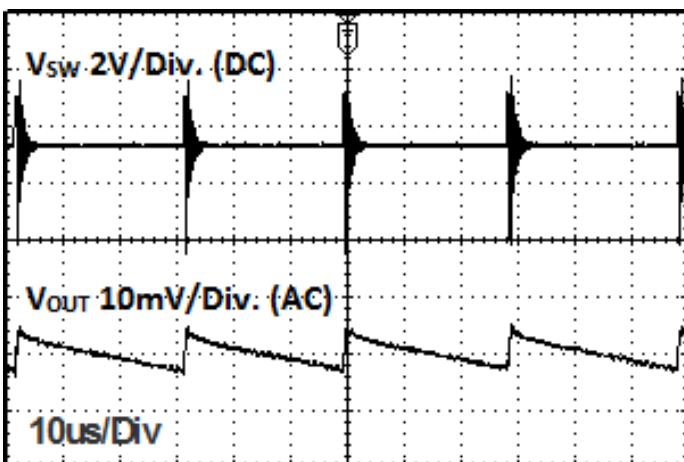

Fig 9: Output Voltage Ripple Response Characteristics ($V_{IN}=5V$, $V_{OUT}=3.3V$, $I_{OUT}=0$, $FREQ=L$, $MODE=L$)

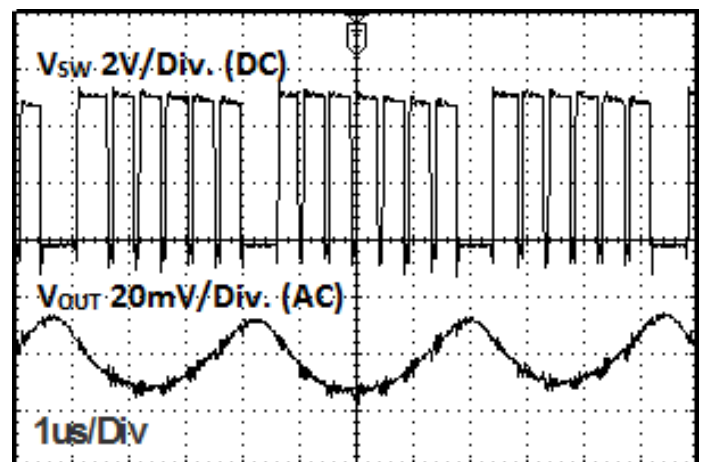

Fig 10: Output Voltage Ripple Response Characteristics ($V_{IN}=5V$, $V_{OUT}=3.3V$, $I_{OUT}=3A$, $FREQ=L$, $MODE=L$)

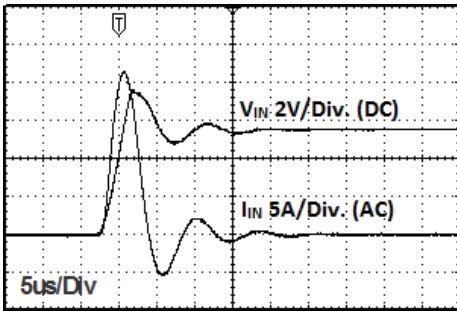

Fig 11: Hot Plug-in Test with Zener Diode P4SMA6.8A, $V_{IN}=5.5V$, $V_{OUT}=3.3V$, $I_{OUT}=3A$, FREQ=L, MODE=H

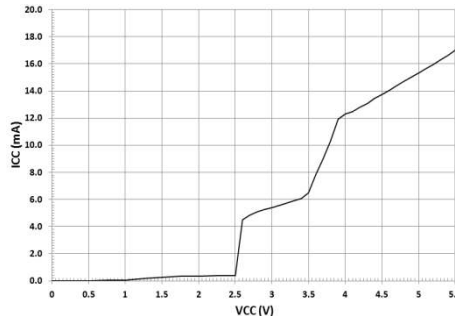

Fig 12: Circuit Current vs. Power supply Voltage Characteristics (Temp=25°C, FREQ=L, MODE=H)

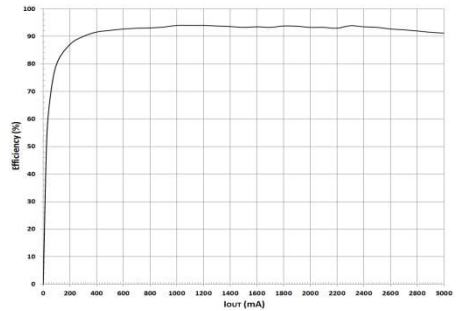

Fig 13: Electric Power Conversion Rate ($V_{OUT}=3.3V$, FREQ=L, MODE=H)

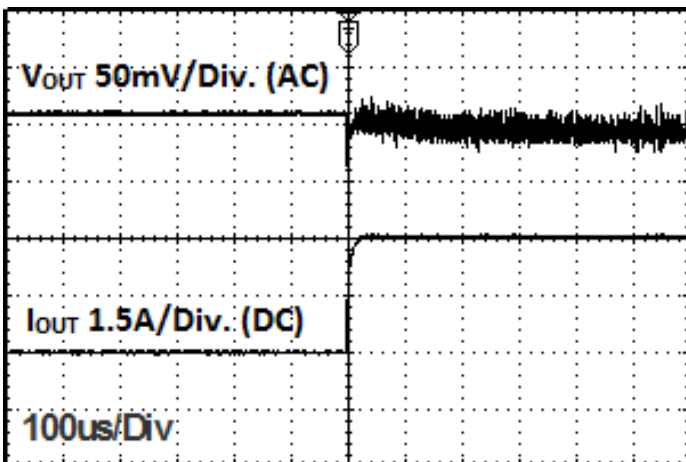

Fig 14: Load Response Characteristics ($V_{IN}=5V$, $V_{OUT}=3.3V$, $I_{OUT}=0 \rightarrow 3A$, FREQ=L, MODE=H)

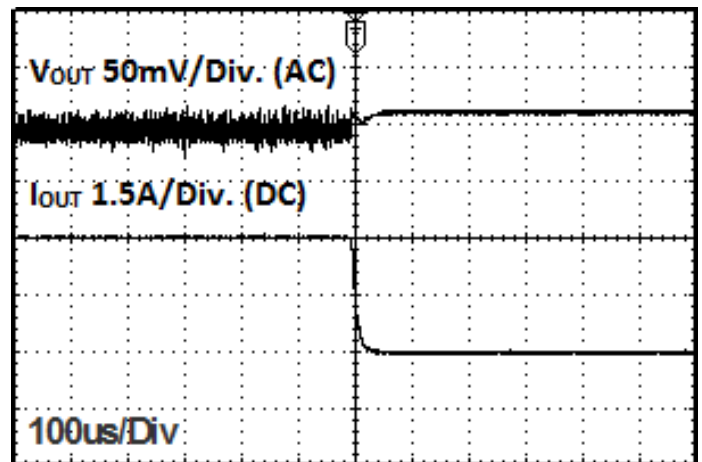

Fig 15: Load Response Characteristics ($V_{IN}=5V$, $V_{OUT}=3.3V$, $I_{OUT}=3A \rightarrow 0$, FREQ=L, MODE=H)

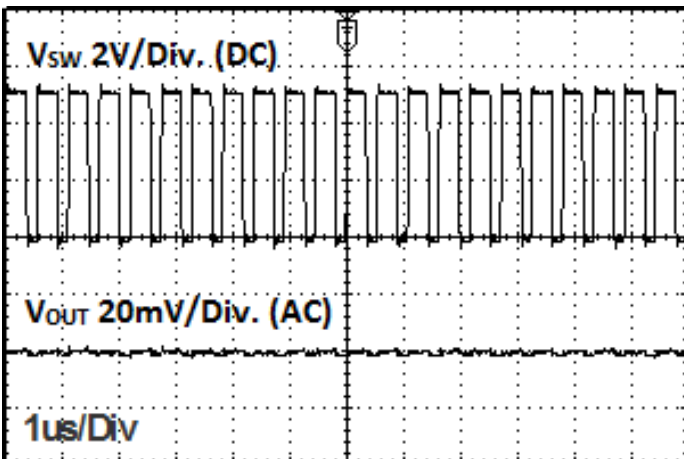

Fig 16: Output Voltage Ripple Response Characteristics ($V_{IN}=5V$, $V_{OUT}=3.3V$, $I_{OUT}=0$, FREQ=L, MODE=H)

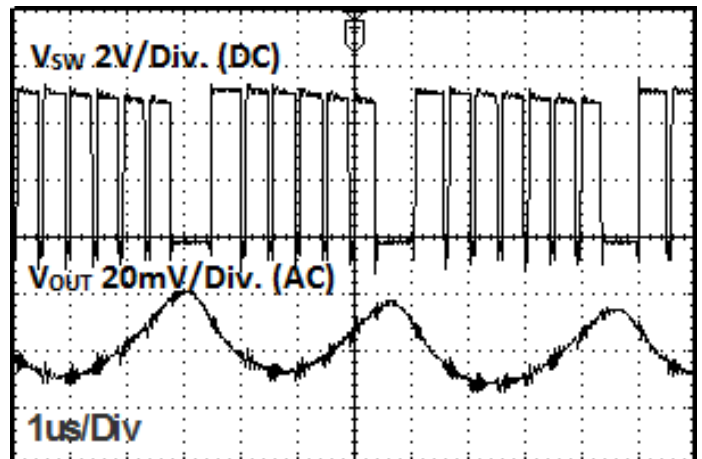

Fig 17: Output Voltage Ripple Response Characteristics ($V_{IN}=5V$, $V_{OUT}=3.3V$, $I_{OUT}=3A$, FREQ=L, MODE=H)

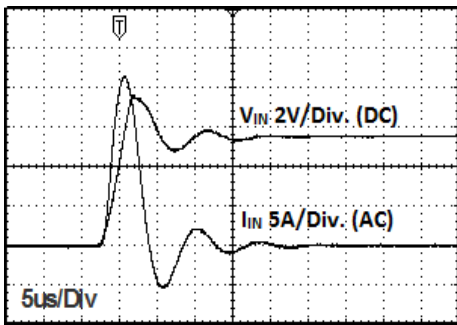

Fig 18: Hot Plug-in Test with Zener Diode P4SMA6.8A, $V_{IN}=5.5V$, $V_{OUT}=3.3V$, $I_{OUT}=3A$, FREQ=H, MODE=L

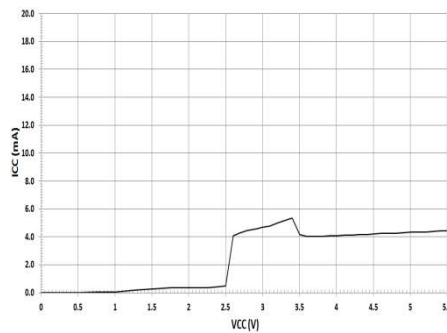

Fig 19: Circuit Current vs. Power supply Voltage Characteristics (Temp=25°C, FREQ=H, MODE=L)

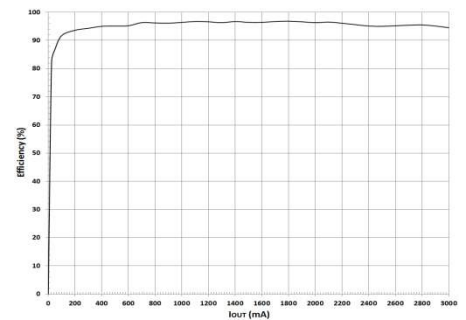

Fig 20: Electric Power Conversion Rate ($V_{OUT}=3.3V$, FREQ=H, MODE=L)

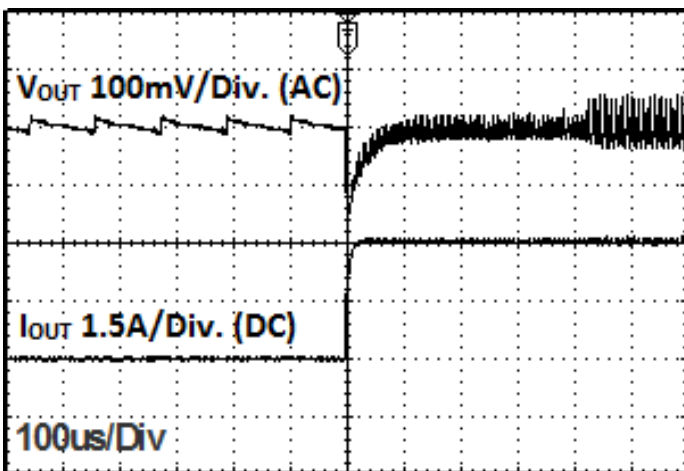

Fig 21: Load Response Characteristics ($V_{IN}=5V$, $V_{OUT}=3.3V$, $I_{OUT}=0 \rightarrow 3A$, FREQ=H, MODE=L)

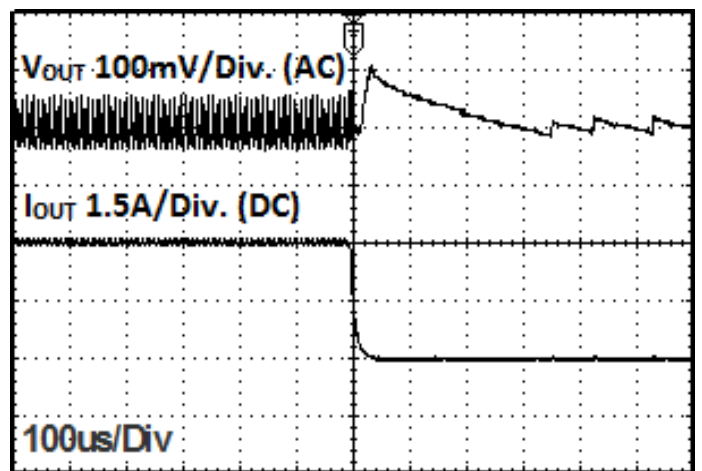

Fig 22: Load Response Characteristics ($V_{IN}=5V$, $V_{OUT}=3.3V$, $I_{OUT}=3A \rightarrow 0$, FREQ=H, MODE=L)

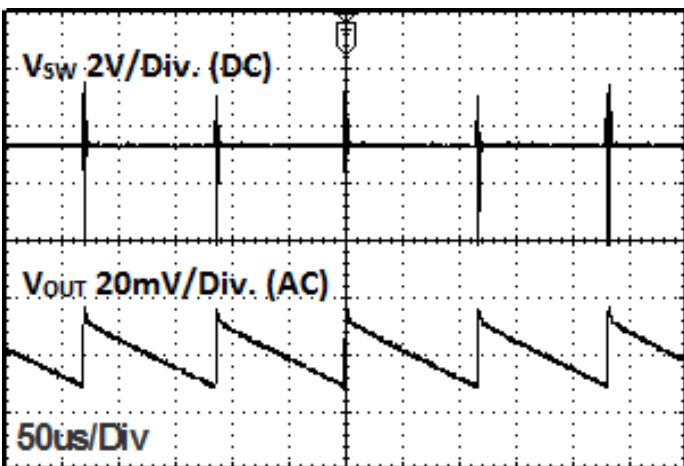

Fig 23: Output Voltage Ripple Response Characteristics ($V_{IN}=5V$, $V_{OUT}=3.3V$, $I_{OUT}=0$, FREQ=H, MODE=L)

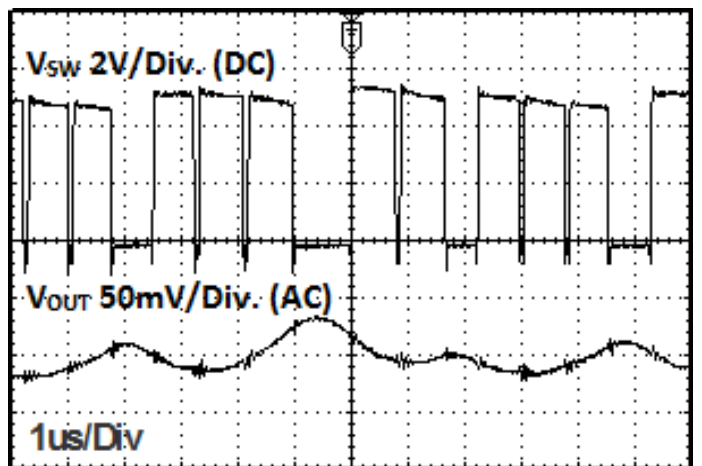

Fig 24: Output Voltage Ripple Response Characteristics ($V_{IN}=5V$, $V_{OUT}=3.3V$, $I_{OUT}=3A$, FREQ=H, MODE=L)

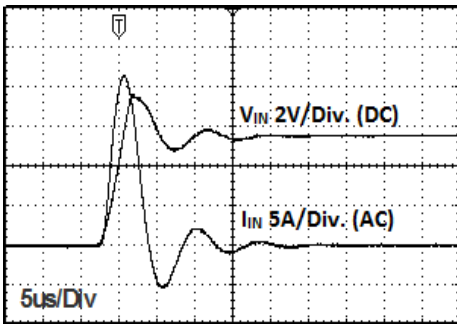

Fig 25: Hot Plug-in Test with Zener Diode P4SMA6.8A, $V_{IN}=5.5V$, $V_{OUT}=3.3V$, $I_{OUT}=3A$, FREQ=H, MODE=H

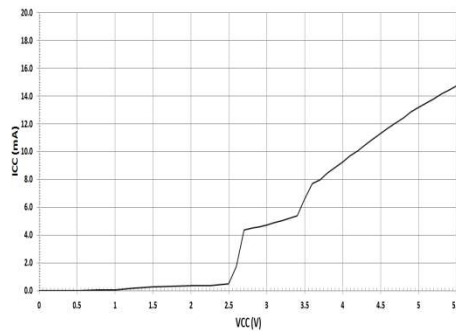

Fig 26: Circuit Current vs. Power supply Voltage Characteristics (Temp=25°C, FREQ=H, MODE=H)

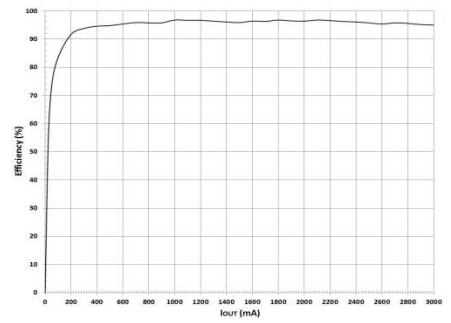

Fig 27: Electric Power Conversion Rate ($V_{OUT}=3.3V$, FREQ=H, MODE=H)

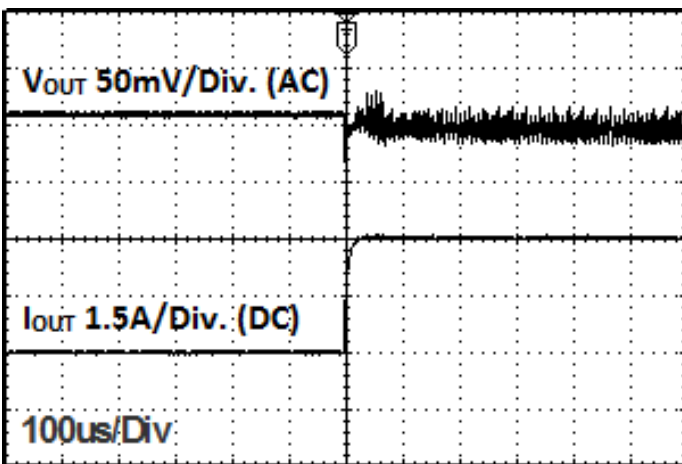

Fig 28: Load Response Characteristics ($V_{IN}=5V$, $V_{OUT}=3.3V$, $I_{OUT}=0 \rightarrow 3A$, FREQ=H, MODE=H)

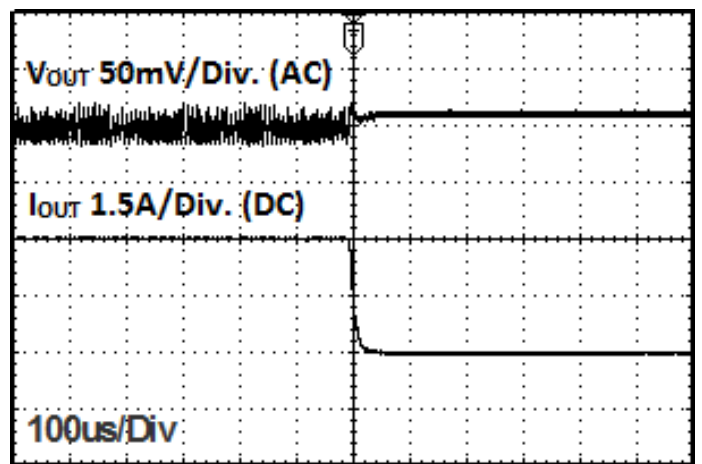

Fig 29: Load Response Characteristics ($V_{IN}=5V$, $V_{OUT}=3.3V$, $I_{OUT}=3A \rightarrow 0$, FREQ=H, MODE=H)

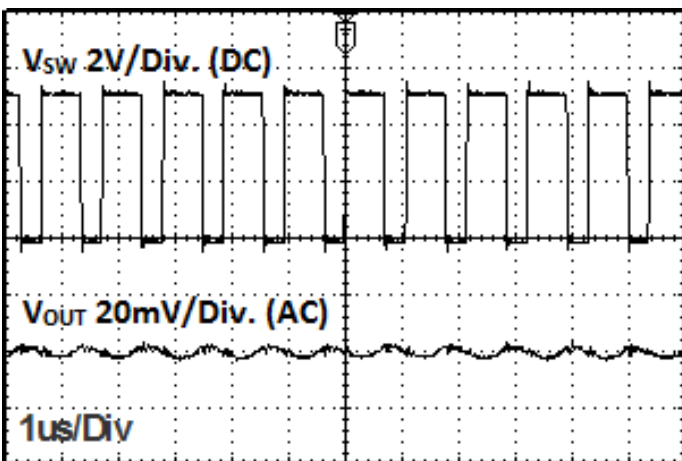

Fig 30: Output Voltage Ripple Response Characteristics ($V_{IN}=5V$, $V_{OUT}=3.3V$, $I_{OUT}=0$, FREQ=H, MODE=H)

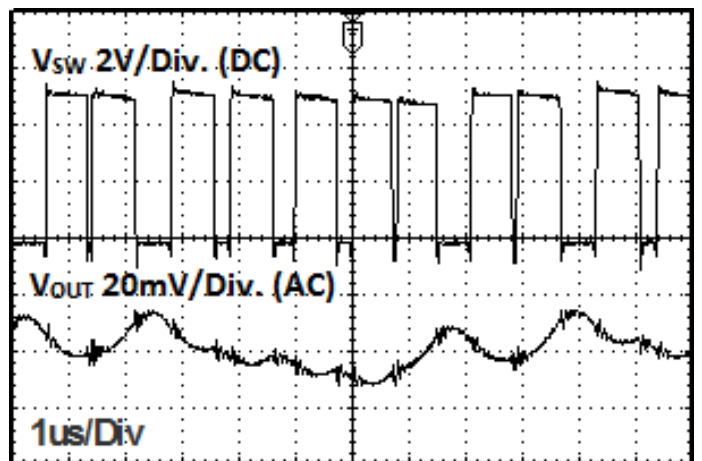

Fig 31: Output Voltage Ripple Response Characteristics ($V_{IN}=5V$, $V_{OUT}=3.3V$, $I_{OUT}=3A$, FREQ=H, MODE=H)

• Evaluation Board Layout Guidelines

In the step-down DC/DC converter, a large pulse current flows into two loops. The first loop is the one into which the current flows when the High-Side FET is turned ON. The flow starts from the input capacitor C_{IN} , runs through the FET, inductor L and output capacitor C_{OUT} and back to GND of C_{IN} via GND of C_{OUT} . The second loop is the one into which the current flows when the Low-Side FET is turned on. The flow starts from the Low-Side FET, runs through the inductor L and output capacitor C_{OUT} and back to GND of the Low-Side FET via GND of C_{OUT} . Route these two loops as thick and as short as possible to allow noise to be reduced for improved efficiency. It is recommended to connect the input and output capacitors directly to the GND plane. The PCB layout has a great influence on the DC/DC converter in terms of all of the heat generation, noise and efficiency characteristics.

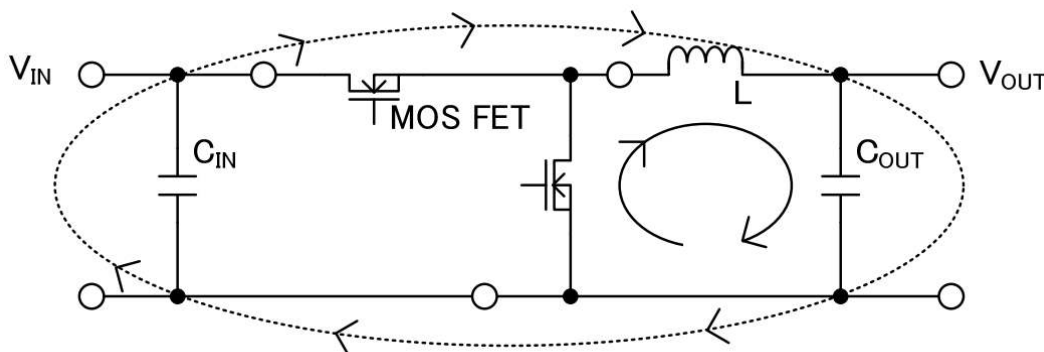

Fig 32: Current Loop of Buck Converter

Accordingly, design the PCB layout considering the following points.

- Connect an input capacitor as close as possible to the IC PVIN terminal on the same plane as the IC.
- If there is any unused area on the PCB, provide a copper foil plane for the GND node to assist heat dissipation from the IC and the surrounding components.
- Switching nodes such as SW are susceptible to noise due to AC coupling with other nodes. Route the coil pattern as thick and as short as possible.
- Provide lines connected to FB far from the SW nodes.
- Place the output capacitor away from the input capacitor in order to avoid the effect of harmonic noise from the input.

Power Dissipation

When designing the PCB layout and peripheral circuitry, sufficient consideration must be given to ensure that the power dissipation is within the allowable dissipation curve.

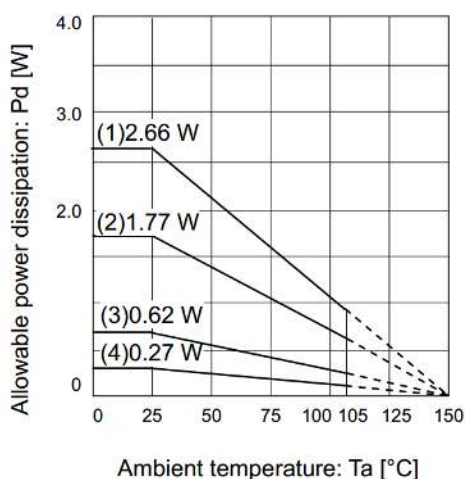

- (1) 4-layer board (surface heat dissipation copper foil 5505 mm²)
(Copper foil laminated on each layer)
 $\theta_{JA} = 47.0^\circ\text{C/W}$
- (2) 4-layer board (surface heat dissipation copper foil 6.28 mm²)
(Copper foil laminated on each layer)
 $\theta_{JA} = 70.62^\circ\text{C/W}$
- (3) 1-layer board (surface heat dissipation copper foil 6.28 mm²)
 $\theta_{JA} = 201.6^\circ\text{C/W}$
- (4) IC only
 $\theta_{JA} = 462.9^\circ\text{C/W}$

Fig 33: Thermal Derating Characteristics

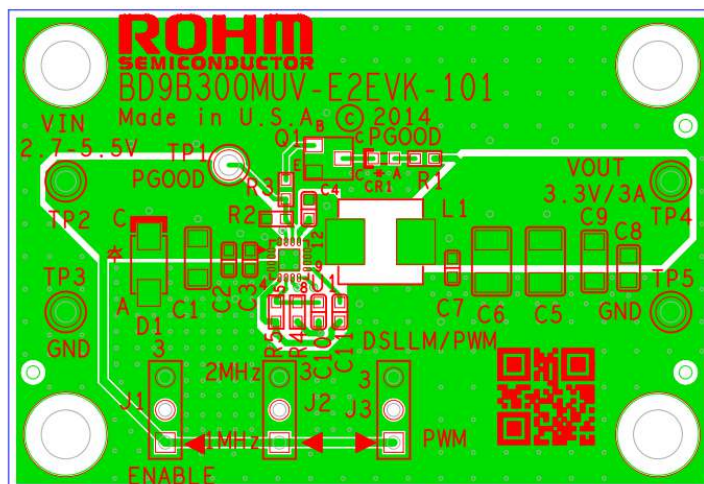

Fig 34: BD9B300MUV-E2EVK-101 Board PCB layout

- **Calculation of Application Circuit Components**

- **Selection of inductor (L)**

The inductance significantly depends on output ripple current. As shown by following equation, the ripple current decreases as the inductor and/or switching frequency increase.

$$\Delta I_L = \frac{(V_{IN} - V_{OUT}) \times V_{OUT}}{L \times V_{IN} \times f}$$

f: switching frequency, L: inductance, ΔI_L : inductor current ripple

As a minimum requirement, the DC current rating of the inductor should be equal to the maximum load current plus half of the inductor current ripples as shown by the following equation.

$$I_{LPEAK} = I_{OUTMAX} + \frac{\Delta I_L}{2}$$

- **Evaluation Board BOM**

Below is a table with the build of materials. Part numbers and supplier references are provided.

Item	Qty.	Ref	Description	Manufacturer	Part Number
1	1	CR1	LED 570NM GREEN WTR CLR 0603 SMD	Rohm	SML-310MTT86
2	1	C1	CAP CER 10UF 10V 10% X5R 1206	Murata	GRM319R61A106KE19D
3	3	C2,C3,C4	CAP CER 0.1UF 16V 10% X7R 0603	Murata	GRM188R71C104KA01D
4	2	C5,C6	CAP CER 22UF 6.3V 10% X5R 1210	Murata	GRM32DR60J226KA01L
5	1	C10	CAP CER 180PF 50V 5% NP0 0603	Murata	GRM1885C1H181JA01D
6	1	D1	DIODE TVS 400W 6.8V UNI 5% SMD	Littelfuse Inc	P4SMA6.8A
7	3	J1,J2,J3	CONN HEADER VERT .100 3POS 15AU	TE Connectivity	87224-3
8	1	L1	INDUCTOR WW 1.5UH 8A SMD	Würth	74437349015
9	1	Q1	TRANSISTOR NPN 40V 0.6A SOT-23	Rohm	SST2222AT116
10	1	R1	RES 140 OHM 1/10W 1% 0603 SMD	Rohm	MCR03ERTF1400
11	1	R2	RES 100K OHM 1/10W 5% 0603 SMD	Rohm	MCR03ERTJ104
12	1	R3	RES 1K OHM 1/10W 5% 0603 SMD	Rohm	MCR03ERTJ102
13	1	R4	RES 160K OHM 1/10W 1% 0603 SMD	Rohm	MCR03ERTF1603
14	1	R5	RES 51K OHM 1/10W 1% 0603 SMD	Rohm	MCR03ERTF5102
15	3	TP1,TP2,TP4	TEST POINT PC MULTI PURPOSE RED	Keystone Electronics	5010
16	2	TP3,TP5	TEST POINT PC MULTI PURPOSE BLK	Keystone Electronics	5011
17	1	U1			
18	3		Shunt jumper for header J1, J2, J3 (item #7), CONN SHUNT 2POS GOLD W/HANDLE	TE Connectivity	881545-1

Notes

No copying or reproduction of this document, in part or in whole, is permitted without the consent of ROHM Co.,Ltd.

The content specified herein is subject to change for improvement without notice.

The content specified herein is for the purpose of introducing ROHM's products (hereinafter "Products"). If you wish to use any such Product, please be sure to refer to the specifications, which can be obtained from ROHM upon request.

Examples of application circuits, circuit constants and any other information contained herein illustrate the standard usage and operations of the Products. The peripheral conditions must be taken into account when designing circuits for mass production.

Great care was taken in ensuring the accuracy of the information specified in this document. However, should you incur any damage arising from any inaccuracy or misprint of such information, ROHM shall bear no responsibility for such damage.

The technical information specified herein is intended only to show the typical functions of and examples of application circuits for the Products. ROHM does not grant you, explicitly or implicitly, any license to use or exercise intellectual property or other rights held by ROHM and other parties. ROHM shall bear no responsibility whatsoever for any dispute arising from the use of such technical information.

The Products specified in this document are intended to be used with general-use electronic equipment or devices (such as audio visual equipment, office-automation equipment, communication devices, electronic appliances and amusement devices).

The Products specified in this document are not designed to be radiation tolerant.

While ROHM always makes efforts to enhance the quality and reliability of its Products, a Product may fail or malfunction for a variety of reasons.

Please be sure to implement in your equipment using the Products safety measures to guard against the possibility of physical injury, fire or any other damage caused in the event of the failure of any Product, such as derating, redundancy, fire control and fail-safe designs. ROHM shall bear no responsibility whatsoever for your use of any Product outside of the prescribed scope or not in accordance with the instruction manual.

The Products are not designed or manufactured to be used with any equipment, device or system which requires an extremely high level of reliability the failure or malfunction of which may result in a direct threat to human life or create a risk of human injury (such as a medical instrument, transportation equipment, aerospace machinery, nuclear-reactor controller, fuel-controller or other safety device). ROHM shall bear no responsibility in any way for use of any of the Products for the above special purposes. If a Product is intended to be used for any such special purpose, please contact a ROHM sales representative before purchasing.

If you intend to export or ship overseas any Product or technology specified herein that may be controlled under the Foreign Exchange and the Foreign Trade Law, you will be required to obtain a license or permit under the Law.



Thank you for your accessing to ROHM product information.
More detail product information and catalogs are available, please contact us.

ROHM Customer Support System

<http://www.rohm.com/contact/>