

## 3.3-V PHASE-LOCK LOOP CLOCK DRIVER WITH 3-STATE OUTPUTS

### FEATURES

- Low Output Skew for Clock-Distribution and Clock-Generation Applications
- Operates at 3.3-V  $V_{CC}$
- Distributes One Clock Input to Six Outputs
- One Select Input Configures Three Outputs to Operate at One-Half or Double the Input Frequency
- No External RC Network Required
- On-Chip Series Damping Resistors
- External Feedback Pin (FBIN) Is Used to Synchronize the Outputs to the Clock Input
- Application for Synchronous DRAM, High-Speed Microprocessor
- TTL-Compatible Inputs and Outputs
- Outputs Drive 50- $\Omega$  Parallel-Terminated Transmission Lines
- State-of-the-Art *EPIC-IIB*<sup>™</sup> BiCMOS Design Significantly Reduces Power Dissipation
- Distributed  $V_{CC}$  and Ground Pins Reduce Switching Noise
- Packaged in Plastic 28-Pin Shrink Small-Outline Package

DB PACKAGE  
(TOP VIEW)

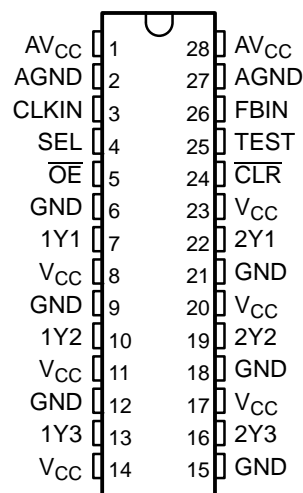

### DESCRIPTION

The CDC2536 is a high-performance, low-skew, low-jitter clock driver. It uses a phase-lock loop (PLL) to precisely align, in both frequency and phase, the clock output signals to the clock input (CLKIN) signal. It is specifically designed for use with synchronous DRAMs and popular microprocessors operating at speeds from 50 MHz to 100 MHz or down to 25 MHz on outputs configured as half-frequency outputs. The CDC2536 operates at 3.3-V  $V_{CC}$  and is designed to drive a 50- $\Omega$  transmission line. The CDC2536 also provides on-chip series-damping resistors, eliminating the need for external termination components.

The feedback (FBIN) input is used to synchronize the output clocks in frequency and phase to the input clock (CLKIN). One of the six output clocks must be fed back to FBIN for the PLL to maintain synchronization between CLKIN and the outputs. The output used as the feedback pin is synchronized to the same frequency as CLKIN.

The Y outputs can be configured to switch in phase and at the same frequency as CLKIN. The select (SEL) input configures three Y outputs to operate at one-half or double the CLKIN frequency, depending on which pin is fed back to FBIN (see Tables 1 and 2). All output signal duty cycles are adjusted to 50% independent of the duty cycle at the input clock.

Output-enable ( $\overline{OE}$ ) is provided for output control. When  $\overline{OE}$  is high, the outputs are in the high-impedance state. When  $\overline{OE}$  is low, the outputs are active. TEST is used for factory testing of the device and can be used to bypass the PLL. TEST should be strapped to GND for normal operation.

Unlike many products containing PLLs, the CDC2536 does not require external RC networks. The loop filter for the PLL is included on-chip, minimizing component count, board space, and cost.



Please be aware that an important notice concerning availability, standard warranty, and use in critical applications of Texas Instruments semiconductor products and disclaimers thereto appears at the end of this data sheet.

*EPIC-IIB* is a trademark of Texas Instruments.

Because it is based on PLL circuitry, the CDC2536 requires a stabilization time to achieve phase lock of the feedback signal to the reference signal. This stabilization time is required following power up and application of a fixed-frequency, fixed-phase signal at CLKIN, as well as following any changes to the PLL reference or feedback signals. Such changes occur upon change of SEL, enabling the PLL via TEST, and upon enable of all outputs via  $\overline{OE}$ .

The CDC2536 is characterized for operation from 0°C to 70°C.

### DETAILED DESCRIPTION OF OUTPUT CONFIGURATIONS

The voltage-controlled oscillator (VCO) used in the CDC2536 has a frequency range of 100 MHz to 200 MHz, twice the operating frequency of the CDC2536 outputs. The output of the VCO is divided by two and by four to provide reference frequencies with a 50% duty cycle of one-half and one-fourth the VCO frequency. SEL determines which of the two signals is buffered to each bank of device outputs.

One device output must be externally wired to FBIN to complete the PLL. The VCO operates such that the frequency of the output matches that of CLKIN. In the case that a VCO/2 output is wired to FBIN, the VCO must operate at twice the CLKIN frequency resulting in device outputs that operate at either the same or one-half the CLKIN frequency. If a VCO/4 output is wired to FBIN, the device outputs operate at the same or twice the CLKIN frequency.

#### Output Configuration A

Output configuration A is valid when any output configured as a 1× frequency output in Table 1 is fed back to FBIN. The input frequency range for CLKIN is 50 MHz to 100 MHz when using output configuration A. Outputs configured as 1/2× outputs operate at half the CLKIN frequency, while outputs configured as 1× outputs operate at the same frequency as CLKIN.

**Table 1. Output Configuration A**

INPUT	OUTPUTS	
SEL	1/2× FREQUENCY	1× FREQUENCY
L	None	All
H	1Yn	2Yn

#### Output Configuration B

Output configuration B is valid when any output configured as a 1× frequency output in Table 2 is fed back to FBIN. The input frequency range for CLKIN is 25 MHz to 50 MHz when using output configuration B. Outputs configured as 1× outputs operate at the CLKIN frequency, while outputs configured as 2× outputs operate at double the frequency of CLKIN.

**Table 2. Output Configuration B**

INPUT	OUTPUTS	
SEL	1× FREQUENCY	2× FREQUENCY
H	1Yn	2Yn
L	All	None



**FUNCTIONAL BLOCK DIAGRAM (continued)**

**Terminal Functions**

TERMINAL NAME	NO.	I/O	DESCRIPTION
CLKIN	3	I	Clock input. CLKIN provides the clock signal to be distributed by the CDC2536 clock-driver circuit. CLKIN provides the reference signal to the integrated PLL that generates the clock output signals. CLKIN must have a fixed frequency and fixed phase for the phase-lock loop to obtain phase lock. Once the circuit is powered up and a valid CLKIN signal is applied, a stabilization time is required for the PLL to phase lock the feedback signal to its reference signal.
$\overline{\text{CLR}}$	24	I	$\overline{\text{CLR}}$ is used for testing purposes only. Connect $\overline{\text{CLR}}$ to GND for normal operation.
FBIN	26	I	Feedback input. FBIN provides the feedback signal to the internal PLL. FBIN must be hardwired to one of the six clock outputs to provide frequency and phase lock. The internal PLL adjusts the output clocks to obtain zero phase delay between the FBIN and differential CLKIN inputs.
$\overline{\text{OE}}$	5	I	Output enable. $\overline{\text{OE}}$ is the output enable for all outputs. When $\overline{\text{OE}}$ is low, all outputs are enabled. When $\overline{\text{OE}}$ is high, all outputs are in the high-impedance state. Since the feedback signal for the PLL is taken directly from an output, placing the outputs in the high-impedance state interrupts the feedback loop; therefore, when a high-to-low transition occurs at $\overline{\text{OE}}$ , enabling the output buffers, a stabilization time is required before the PLL obtains phase lock.
SEL	4	I	Output configuration select. SEL selects the output configuration for each output bank (e.g. 1×, 1/2×, or 2×).(see Tables 1 and 2).
TEST	25	I	TEST is used to bypass the PLL circuitry for factory testing of the device. When TEST is low, all outputs operate using the PLL circuitry. When TEST is high, the outputs are placed in a test mode that bypasses the PLL circuitry. TEST should be grounded for normal operation.
1Y1-1Y3	7, 10, 13	O	These outputs are configured by SEL to transmit one-half or one-fourth the frequency of the VCO. The relationship between the CLKIN frequency and the output frequency is dependent on SEL. The duty cycle of the Y output signals is nominally 50%, independent of the duty cycle of the CLKIN signal. Each output has an internal series resistor to dampen transmission-line effects and improve the signal integrity at the load.
2Y1-2Y3	22, 19, 16	O	These outputs transmit one-half the frequency of the VCO. The relationship between the CLKIN frequency and the output frequency is dependent on the frequency of the output being fed back to FBIN. The duty cycle of the Y output signals is nominally 50%, independent of the duty cycle of the CLKIN signal. Each output has an internal series resistor to dampen transmission-line effects and improve the signal integrity at the load.

**ABSOLUTE MAXIMUM RATINGS**

over operating free-air temperature range (unless otherwise noted)<sup>(1)</sup>

	UNIT
Supply voltage range, $V_{CC}$	-0.5 V to 4.6 V
Input voltage range, $V_I$ (see <sup>(2)</sup> )	-0.5 V to 7 V
Voltage range applied to any output in the high state or power-off state, $V_O$ (see <sup>(2)</sup> )	-0.5 V to 5.5 V
Current into any output in the low state, $I_O$	24 mA
Input clamp current, $I_{IK}(V_I < 0)$	-20 mA
Output clamp current, $I_{OK}(V_O < 0)$	-50 mA
Maximum power dissipation at $T_A = 55^\circ\text{C}$ (in still air) (see <sup>(3)</sup> )	0.68 W
Storage temperature range, $T_{stg}$	-65°C to 150°C

- (1) Stresses beyond those listed under absolute maximum ratings may cause permanent damage to the device. These are stress ratings only, and functional operation of the device at these or any other conditions beyond those indicated under recommended operating conditions is not implied. Exposure to absolute-maximum-rated conditions for extended periods may affect device reliability.
- (2) The input and output negative-voltage ratings may be exceeded if the input and output clamp-current ratings are observed.
- (3) The maximum package power dissipation is calculated using a junction temperature of 150°C and a board trace length of 75 mils. For more information, refer to the *Package Thermal Considerations* application note in the 1994 *ABT Advanced BiCMOS Technology Data Book*, literature number SCBD002B.

## RECOMMENDED OPERATING CONDITIONS (SEE <sup>(1)</sup>)

		MIN	MAX	UNIT
V <sub>CC</sub>	Supply voltage	3	3.6	V
V <sub>IH</sub>	High-level input voltage	2		V
V <sub>IL</sub>	Low-level input voltage		0.8	V
V <sub>I</sub>	Input voltage	0	5.5	V
I <sub>OH</sub>	High-level output current		12	mA
I <sub>OL</sub>	Low-level output current		12	mA
T <sub>A</sub>	Operating free-air temperature	0	70	°C

(1) Unused inputs must be held high or low to prevent them from floating.

## ELECTRICAL CHARACTERISTICS

over recommended operating free-air temperature range, T<sub>A</sub> = 25°C (unless otherwise noted)

PARAMETER	TEST CONDITIONS		MIN	MAX	UNIT
V <sub>IK</sub>	V <sub>CC</sub> = 3 V,	I <sub>I</sub> = -18 mA		1.2	V
V <sub>OH</sub>	V <sub>CC</sub> = MIN to MAX <sup>(1)</sup> , I <sub>OH</sub> = -100 μA		V <sub>CC</sub> - 0.2		V
	V <sub>CC</sub> = 3 V,	I <sub>OH</sub> = -12 mA	2		
V <sub>OL</sub>	V <sub>CC</sub> = 3 V,	I <sub>OL</sub> = 100 μA		0.2	V
	V <sub>CC</sub> = 3 V,	I <sub>OL</sub> = 12 mA		0.8	
I <sub>I</sub>	V <sub>CC</sub> = 0 or MAX <sup>(1)</sup> , V <sub>I</sub> = 3.6 V			±10	μA
	V <sub>CC</sub> = 3.6 V,	V <sub>I</sub> = V <sub>CC</sub> or GND		±1	
I <sub>OZH</sub>	V <sub>CC</sub> = 3.6 V,	V <sub>O</sub> = 3 V		10	μA
I <sub>OZL</sub>	V <sub>CC</sub> = 3.6 V,	V <sub>O</sub> = 0		10	μA
I <sub>CC</sub>	V <sub>CC</sub> = 3.6 V, I <sub>O</sub> = 0, V <sub>I</sub> = V <sub>CC</sub> or GND		Outputs high		mA
			Outputs low		
			Outputs disabled		
C <sub>i</sub>	V <sub>I</sub> = V <sub>CC</sub> or GND			6	pF
C <sub>o</sub>	V <sub>O</sub> = V <sub>CC</sub> or GND			9	pF

(1) For conditions shown as MIN or MAX, use the appropriate value specified under recommended operating conditions.

## TIMING REQUIREMENTS

over recommended ranges of supply voltage and operating free-air temperature

		MIN	MAX	UNIT
f <sub>clock</sub>	Clock frequency	When VCO is operating at four times the CLKIN frequency		MHz
		When VCO is operating at double the CLKIN frequency		
	Duty cycle, CLKIN	40%	60%	
Stabilization time <sup>(1)</sup>	After SEL		50	μs
	After $\overline{OE}$ ↓		50	
	After power up		50	
	After CLKIN		50	

(1) Time required for the integrated PLL circuit to obtain phase lock of its feedback signal to its reference signal. For phase lock to be obtained, a fixed-frequency, fixed-phase reference signal must be present at CLKIN. Until phase lock is obtained, the specifications for propagation delay and skew parameters given in the switching characteristics table are not applicable.

**SWITCHING CHARACTERISTICS**

over recommended ranges of supply voltage and operating free-air temperature,  $C_L = 15 \text{ pF}$  (see <sup>(1)</sup> and Figure 1, Figure 2 and Figure 3)

PARAMETER	FROM (INPUT)	TO (OUTPUT)	MIN	MAX	UNIT
$f_{max}$			100		MHz
Duty cycle		Y	45%	55%	
$t_{phase \ error}^{(2)}$	CLKIN↑	Y↑	500	+500	ps
$t_{jitter \ (RMS)}$	CLKIN↑	Y↑		200	ps
$t_{sk(o)}^{(2)}$				0.5	ns
$t_{sk(pr)}^{(2)}$				1	ns
$t_r$				1.4	ns
$t_f$				1.4	ns

- (1) The specifications for parameters in this table are applicable only after any appropriate stabilization time has elapsed.
- (2) The propagation delay,  $t_{phase \ error}$ , is dependent on the feedback path from any output to FBIN. The  $t_{phase \ error}$ ,  $t_{sk(o)}$ , and  $t_{sk(pr)}$  specifications are only valid for equal loading of all outputs.

**PARAMETER MEASUREMENT INFORMATION**

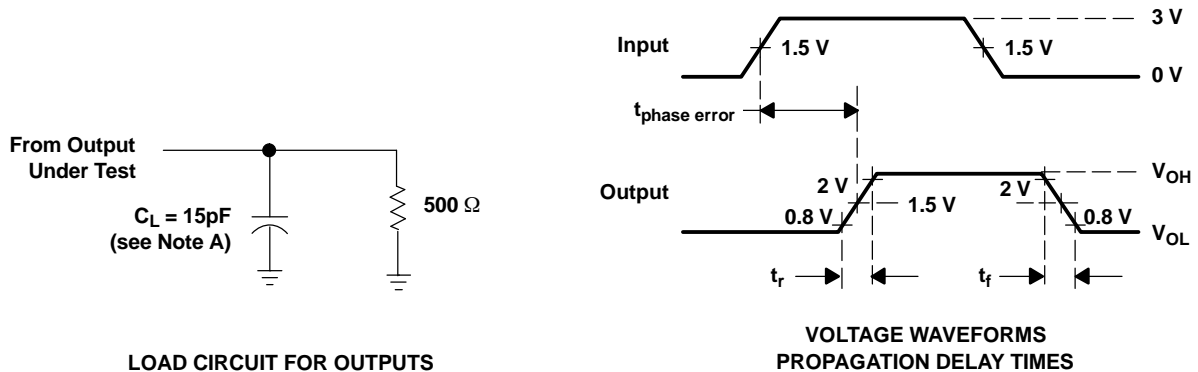

- A. NOTES: .  $C_L$  includes probe and jig capacitance.
- B. All input pulses are supplied by generators having the following characteristics:  $PRR \leq 100 \text{ MHz}$ ,  $Z_O = 50 \ \Omega$ ,  $t_r \leq 2.5 \text{ ns}$ ,  $t_f \leq 2.5 \text{ ns}$ .
- C. The outputs are measured one at a time with one transition per measurement.

**Figure 1. Load Circuit and Voltage Waveforms**

**PARAMETER MEASUREMENT INFORMATION (continued)**

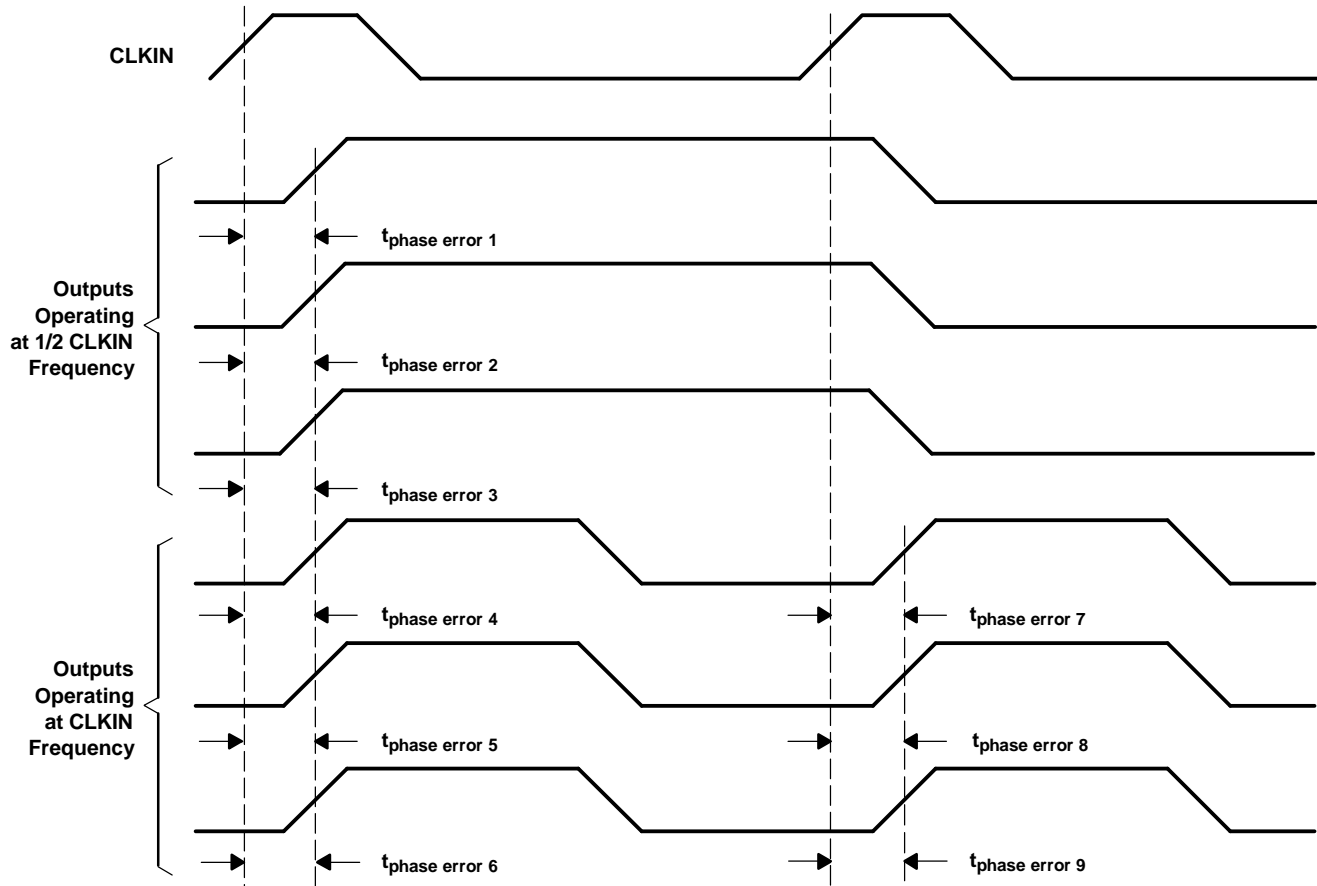

- A. NOTES: . Output skew,  $t_{\text{sk(o)}}$ , is calculated as the greater of:
- The difference between the fastest and slowest of  $t_{\text{phase error } n}$  ( $n = 1, 2, \dots 6$ )
  - The difference between the fastest and slowest of  $t_{\text{phase error } n}$  ( $n = 7, 8, 9$ )
- B. Process skew,  $t_{\text{sk(pr)}}$ , is calculated as the greater of:
- The difference between the maximum and minimum  $t_{\text{phase error } n}$  ( $n = 1, 2, \dots 6$ ) across multiple devices under identical operating conditions
  - The difference between the maximum and minimum  $t_{\text{phase error } n}$  ( $n = 7, 8, 9$ ) across multiple devices under identical operating conditions

**Figure 2. Waveforms for Calculations of  $t_{\text{sk(o)}}$  and  $t_{\text{sk(pr)}}$**

PARAMETER MEASUREMENT INFORMATION (continued)

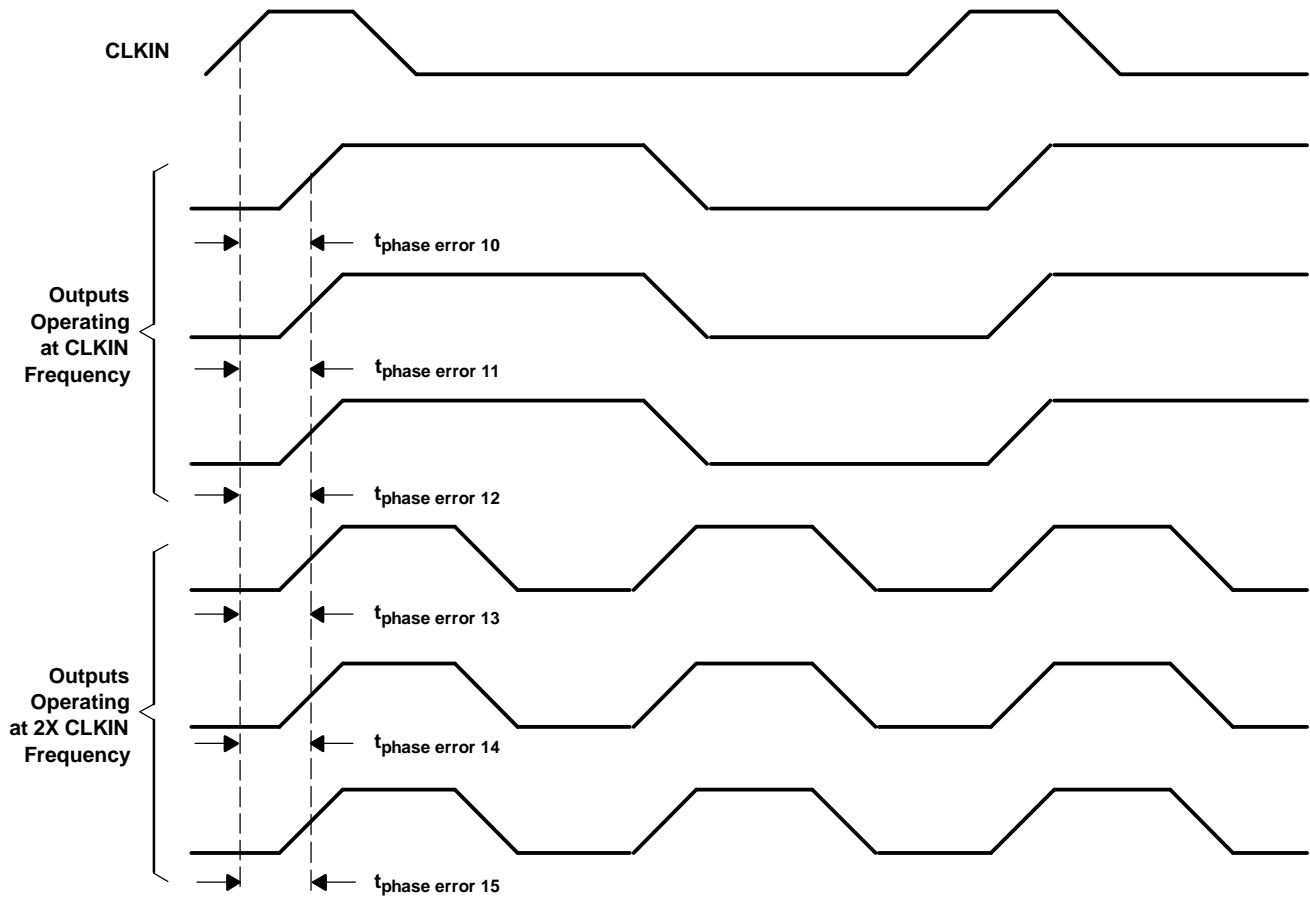

- A. NOTES: . Output skew,  $t_{sk(o)}$ , is calculated as the greater of:
- The difference between the fastest and slowest of  $t_{\text{phase error } n}$  ( $n = 10, 11, \dots 15$ )
- B. Process skew,  $t_{sk(pr)}$ , is calculated as the greater of:
- The difference between the maximum and minimum  $t_{\text{phase error } n}$  ( $n = 10, 11, \dots 15$ ) across multiple devices under identical operating conditions.

Figure 3. Waveforms for Calculation of  $t_{sk(o)}$  and  $t_{sk(pr)}$



**PACKAGING INFORMATION**

Orderable Device	Status (1)	Package Type	Package Drawing	Pins	Package Qty	Eco Plan (2)	Lead finish/ Ball material (6)	MSL Peak Temp (3)	Op Temp (°C)	Device Marking (4/5)	Samples
CDC2536DB	ACTIVE	SSOP	DB	28	50	RoHS & Green	NIPDAU	Level-1-260C-UNLIM	0 to 70	CDC2536	<a href="#">Samples</a>
CDC2536DBR	ACTIVE	SSOP	DB	28	2000	RoHS & Green	NIPDAU	Level-1-260C-UNLIM	0 to 70	CDC2536	<a href="#">Samples</a>

(1) The marketing status values are defined as follows:

**ACTIVE:** Product device recommended for new designs.

**LIFEBUY:** TI has announced that the device will be discontinued, and a lifetime-buy period is in effect.

**NRND:** Not recommended for new designs. Device is in production to support existing customers, but TI does not recommend using this part in a new design.

**PREVIEW:** Device has been announced but is not in production. Samples may or may not be available.

**OBSELETE:** TI has discontinued the production of the device.

(2) **RoHS:** TI defines "RoHS" to mean semiconductor products that are compliant with the current EU RoHS requirements for all 10 RoHS substances, including the requirement that RoHS substance do not exceed 0.1% by weight in homogeneous materials. Where designed to be soldered at high temperatures, "RoHS" products are suitable for use in specified lead-free processes. TI may reference these types of products as "Pb-Free".

**RoHS Exempt:** TI defines "RoHS Exempt" to mean products that contain lead but are compliant with EU RoHS pursuant to a specific EU RoHS exemption.

**Green:** TI defines "Green" to mean the content of Chlorine (Cl) and Bromine (Br) based flame retardants meet JS709B low halogen requirements of <=1000ppm threshold. Antimony trioxide based flame retardants must also meet the <=1000ppm threshold requirement.

(3) MSL, Peak Temp. - The Moisture Sensitivity Level rating according to the JEDEC industry standard classifications, and peak solder temperature.

(4) There may be additional marking, which relates to the logo, the lot trace code information, or the environmental category on the device.

(5) Multiple Device Markings will be inside parentheses. Only one Device Marking contained in parentheses and separated by a "~" will appear on a device. If a line is indented then it is a continuation of the previous line and the two combined represent the entire Device Marking for that device.

(6) Lead finish/Ball material - Orderable Devices may have multiple material finish options. Finish options are separated by a vertical ruled line. Lead finish/Ball material values may wrap to two lines if the finish value exceeds the maximum column width.

**Important Information and Disclaimer:**The information provided on this page represents TI's knowledge and belief as of the date that it is provided. TI bases its knowledge and belief on information provided by third parties, and makes no representation or warranty as to the accuracy of such information. Efforts are underway to better integrate information from third parties. TI has taken and continues to take reasonable steps to provide representative and accurate information but may not have conducted destructive testing or chemical analysis on incoming materials and chemicals. TI and TI suppliers consider certain information to be proprietary, and thus CAS numbers and other limited information may not be available for release.

In no event shall TI's liability arising out of such information exceed the total purchase price of the TI part(s) at issue in this document sold by TI to Customer on an annual basis.



**TAPE AND REEL INFORMATION**

**QUADRANT ASSIGNMENTS FOR PIN 1 ORIENTATION IN TAPE**



\*All dimensions are nominal

Device	Package Type	Package Drawing	Pins	SPQ	Reel Diameter (mm)	Reel Width W1 (mm)	A0 (mm)	B0 (mm)	K0 (mm)	P1 (mm)	W (mm)	Pin1 Quadrant
CDC2536DBR	SSOP	DB	28	2000	330.0	16.4	8.1	10.4	2.5	12.0	16.0	Q1

**TAPE AND REEL BOX DIMENSIONS**

\*All dimensions are nominal

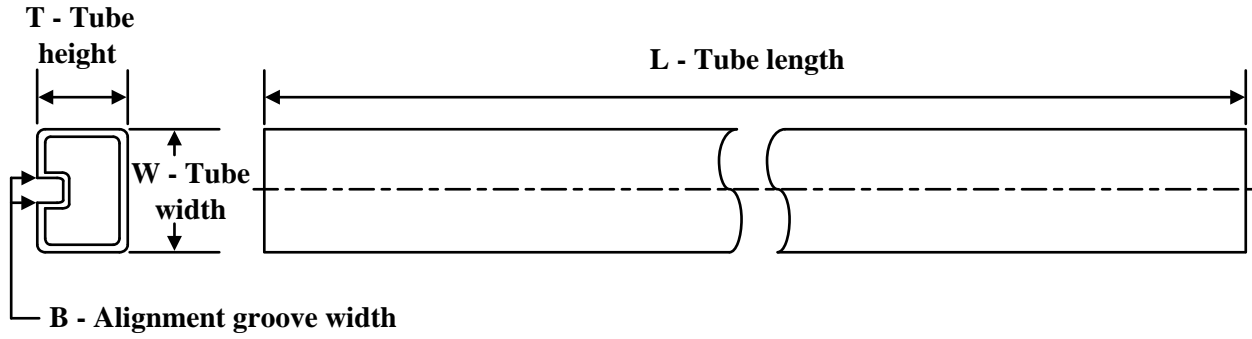
Device	Package Type	Package Drawing	Pins	SPQ	Length (mm)	Width (mm)	Height (mm)
CDC2536DBR	SSOP	DB	28	2000	350.0	350.0	43.0

**TUBE**

\*All dimensions are nominal

Device	Package Name	Package Type	Pins	SPQ	L (mm)	W (mm)	T (μm)	B (mm)
CDC2536DB	DB	SSOP	28	50	530	10.5	4000	4.1

DB0028A



# PACKAGE OUTLINE

SSOP - 2 mm max height

SMALL OUTLINE PACKAGE

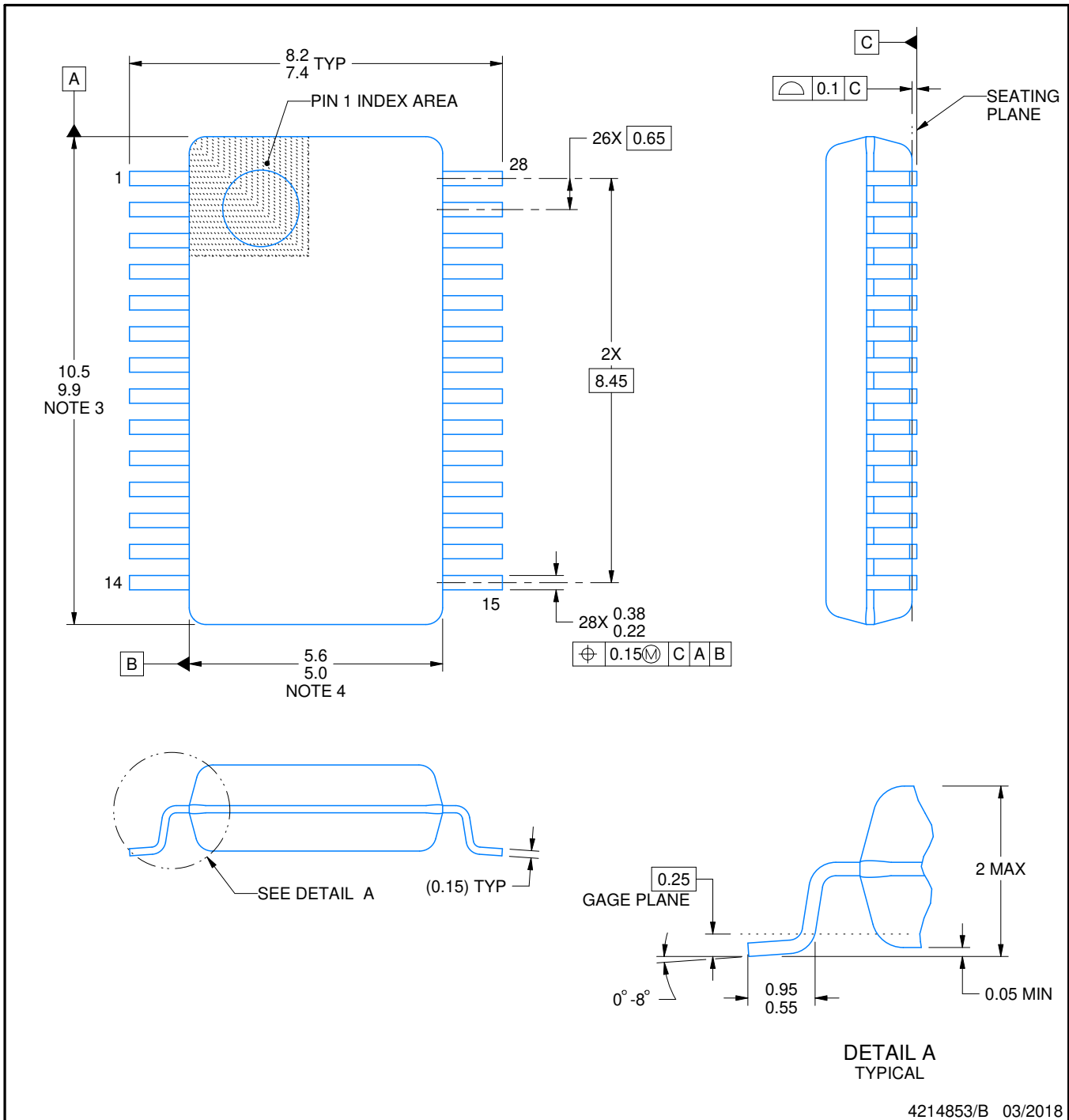

NOTES:

1. All linear dimensions are in millimeters. Any dimensions in parenthesis are for reference only. Dimensioning and tolerancing per ASME Y14.5M.
2. This drawing is subject to change without notice.
3. This dimension does not include mold flash, protrusions, or gate burrs. Mold flash, protrusions, or gate burrs shall not exceed 0.15 mm per side.
4. This dimension does not include interlead flash. Interlead flash shall not exceed 0.25 mm per side.
5. Reference JEDEC registration MO-150.

# EXAMPLE BOARD LAYOUT

DB0028A

SSOP - 2 mm max height

SMALL OUTLINE PACKAGE

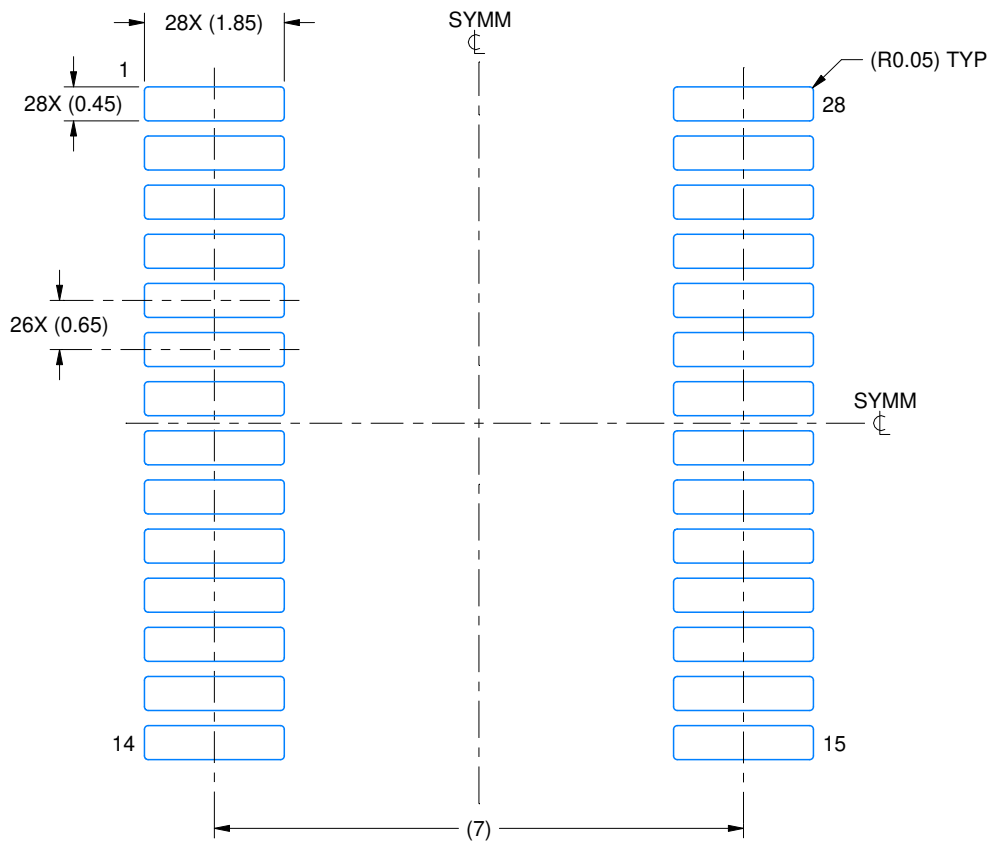

LAND PATTERN EXAMPLE  
EXPOSED METAL SHOWN  
SCALE: 10X

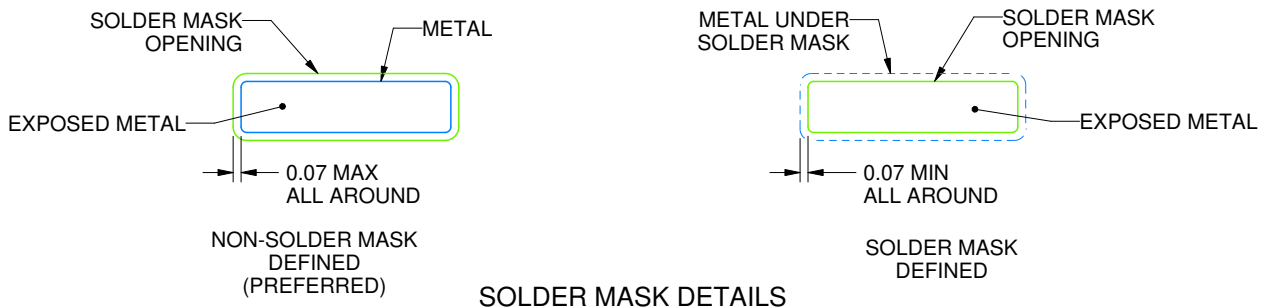

4214853/B 03/2018

NOTES: (continued)

- 6. Publication IPC-7351 may have alternate designs.
- 7. Solder mask tolerances between and around signal pads can vary based on board fabrication site.

# EXAMPLE STENCIL DESIGN

DB0028A

SSOP - 2 mm max height

SMALL OUTLINE PACKAGE

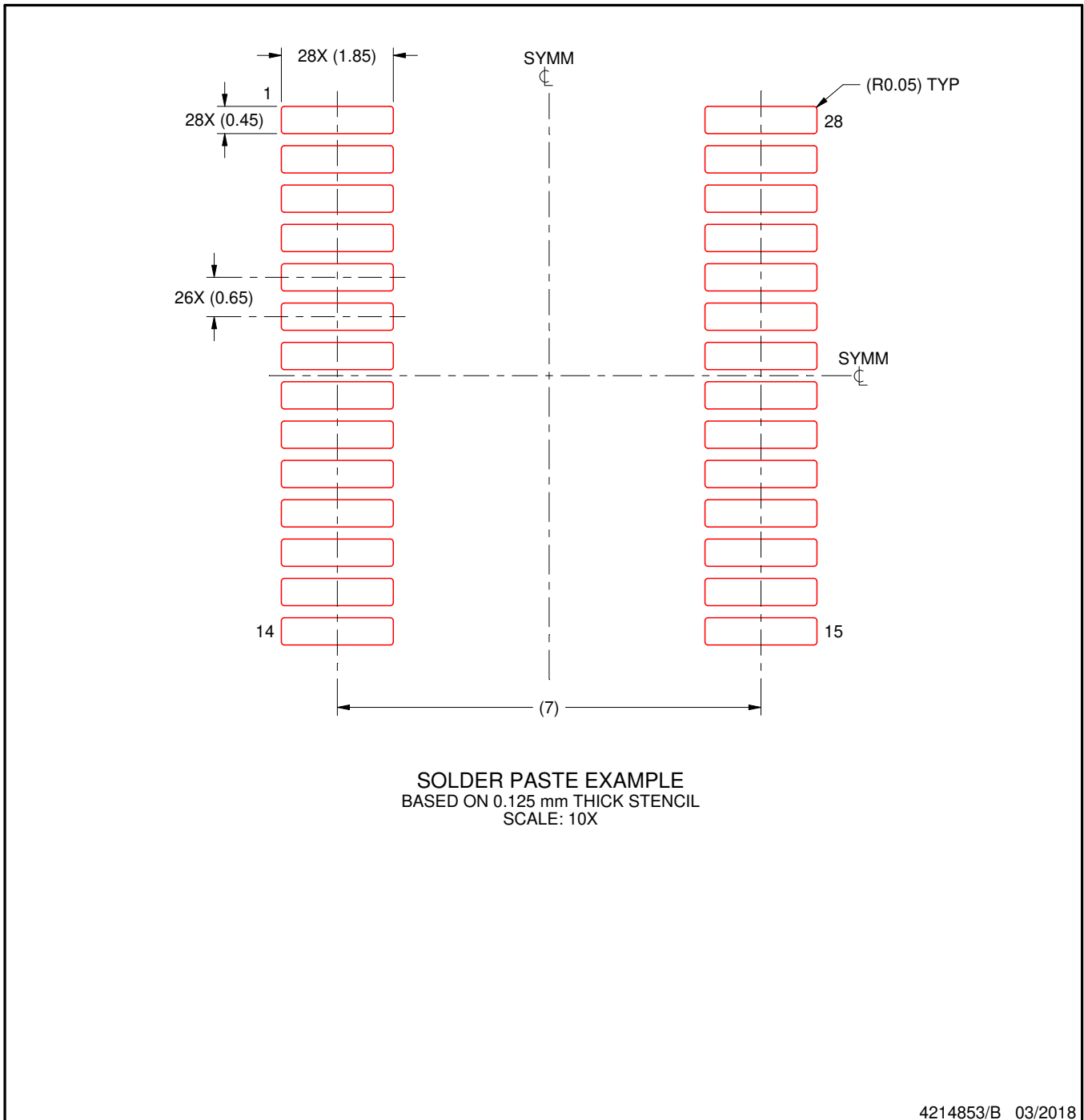

NOTES: (continued)

8. Laser cutting apertures with trapezoidal walls and rounded corners may offer better paste release. IPC-7525 may have alternate design recommendations.
9. Board assembly site may have different recommendations for stencil design.



## IMPORTANT NOTICE AND DISCLAIMER

TI PROVIDES TECHNICAL AND RELIABILITY DATA (INCLUDING DATA SHEETS), DESIGN RESOURCES (INCLUDING REFERENCE DESIGNS), APPLICATION OR OTHER DESIGN ADVICE, WEB TOOLS, SAFETY INFORMATION, AND OTHER RESOURCES "AS IS" AND WITH ALL FAULTS, AND DISCLAIMS ALL WARRANTIES, EXPRESS AND IMPLIED, INCLUDING WITHOUT LIMITATION ANY IMPLIED WARRANTIES OF MERCHANTABILITY, FITNESS FOR A PARTICULAR PURPOSE OR NON-INFRINGEMENT OF THIRD PARTY INTELLECTUAL PROPERTY RIGHTS.

These resources are intended for skilled developers designing with TI products. You are solely responsible for (1) selecting the appropriate TI products for your application, (2) designing, validating and testing your application, and (3) ensuring your application meets applicable standards, and any other safety, security, regulatory or other requirements.

These resources are subject to change without notice. TI grants you permission to use these resources only for development of an application that uses the TI products described in the resource. Other reproduction and display of these resources is prohibited. No license is granted to any other TI intellectual property right or to any third party intellectual property right. TI disclaims responsibility for, and you will fully indemnify TI and its representatives against, any claims, damages, costs, losses, and liabilities arising out of your use of these resources.

TI's products are provided subject to [TI's Terms of Sale](#) or other applicable terms available either on [ti.com](http://ti.com) or provided in conjunction with such TI products. TI's provision of these resources does not expand or otherwise alter TI's applicable warranties or warranty disclaimers for TI products.

TI objects to and rejects any additional or different terms you may have proposed.

Mailing Address: Texas Instruments, Post Office Box 655303, Dallas, Texas 75265  
Copyright © 2022, Texas Instruments Incorporated