

Automotive dual-line TVS in SOT323-3L for CAN bus

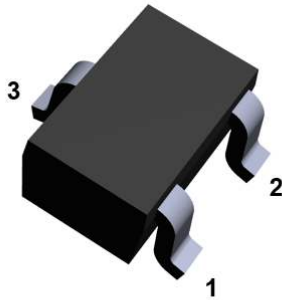

SOT323-3L
(Jedec SC-70)

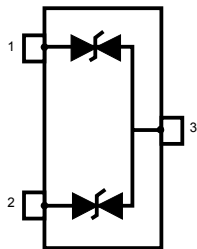

Product status link

ESDCAN02-2BWY, ESDCAN03-2BWY,
ESDCAN04-2BWY, ESDCAN05-2BWY,
ESDCAN06-2BWY

Features

- AEC-Q101 qualified 
- Dual-line ESD and EOS protection
- Breakdown voltage, V_{BR} :
 - ESDCAN02-2BWY: 28.5 V
 - ESDCAN03-2BWY: 26.5 V
 - ESDCAN04-2BWY: 27.5 V
 - ESDCAN05-2BWY: 39 V
 - ESDCAN06-2BWY: 38 V
- Max pulse power up to 170 W (8/20 μ s)
- Low clamping factor V_{CL} / V_{BR}
- ECOPACK2 ROHS compliant component

Complies with the following standards

- UL94, V0
- J-STD-020 MSL level 1
- IPC7531 footprint and JEDEC registered package
- ISO 16750-2 (Jump start and reversed battery tests)
- IEC 61000-4-4 (EFT)
 - 4 kV
- ISO 10605 C = 150 pF, R = 330 Ω , exceeds level 4:
 - \pm 30 kV (contact and air discharge)
- ISO 10605 C = 330 pF, R = 2 k Ω exceeds level 4:
 - \pm 30 kV (contact and air discharge)
- ISO 10605 C = 330 pF, R = 330 Ω exceeds level 4:
 - \pm 30 kV (contact and air discharge)
- ISO 7637-3:
 - Pulse 3a: -150 V
 - Pulse 3b: +150 V
 - Pulse 2a: +/- 85 V

Description

These dual-line CAN transceiver protection devices (TVS) protect both CAN H and CAN L signals of automotive CAN PHY against ISO 7637-3 transients and ESD (electrostatic discharge).

ESDCAN series complies with all the physical layer constraints (jump start, reverse polarity, ...) without compromising the low clamping voltage for an efficient CAN bus protection (controller area network) or LIN bus protection (local interconnect network).

The low line capacitance versions make them compliant with CAN-FD and high speed buses like FlexRay, USB, and even the future CAN XL.

1 Characteristics

Table 1. Absolute ratings ($T_{amb} = 25\text{ }^{\circ}\text{C}$)

Symbol	Parameter		Value	Unit	
V_{PP}	Peak pulse voltage	ISO 10605 - C = 150 pF, R = 330 Ω : Contact and air discharge	30	kV	
		ISO 10605 - C = 330 pF, R = 330 Ω : Contact and air discharge	ESDCAN02-2BWY ESDCAN03-2BWY ESDCAN04-2BWY		30
		ISO 10605 - C = 330 pF, R = 330 Ω : Contact discharge	ESDCAN05-2BWY		22
		Air discharge	ESDCAN06-2BWY		30
		ISO 10605 - C = 330 pF, R = 2 k Ω : Contact and air discharge			30
I_{PP}	Peak pulse current (8/20 μs)	ESDCAN02-2BWY ESDCAN03-2BWY ESDCAN04-2BWY	3.7	A	
		ESDCAN05-2BWY ESDCAN06-2BWY	3		
T_j	Operating junction temperature range		-55 to +175	$^{\circ}\text{C}$	
T_{stg}	Storage temperature range		-55 to +175	$^{\circ}\text{C}$	

Figure 1. Electrical characteristics (definitions)

Symbol	Parameter
V_{BR}	= Breakdown voltage
V_{RM}	= Stand-off voltage
V_{CL}	= Clamping voltage
I_{RM}	= Leakage current at V_{RM}
I_{PP}	= Peak pulse current
R_d	= Dynamic impedance
C_{LINE}	= Input capacitance per line

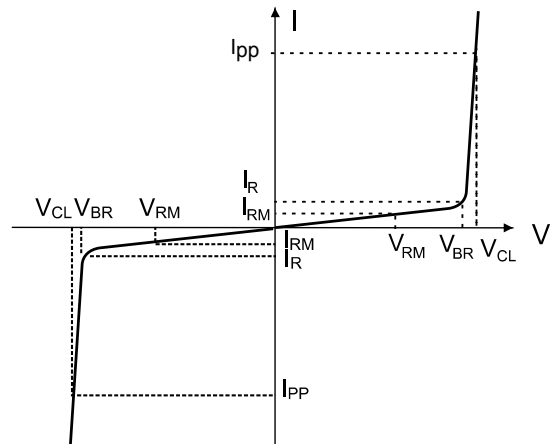

Table 2. Electrical characteristics (values, $T_{amb} = 25\text{ }^{\circ}\text{C}$)

Order code	I_{RM} max. at V_{RM}		V_{BR} at I_R			V_{CL} Pulse ISO7637-3		V_{CL} at I_{PP} (8/20 μs)		C		$\Delta C^{(1)}$	$\alpha T^{(2)}$
			Min.	Max.		3a at -150 V min.	3b at +150 V max.	Max.		Typ.	Max.	Typ.	Typ.
	μA	V	V		mA	V		V	A	pF		pF	$10^{-4}/^{\circ}\text{C}$
ESDCAN02-2BWY	0.01	26.5	28.5	31.7	1	-36	36	44	3	3	3.5	0.01	9
ESDCAN03-2BWY	0.01	24	26.5	29.7	1	-34	34	41	3	3	3.5	0.01	9
ESDCAN04-2BWY	0.05	25.5	27.5	30.7	1	-35	35	43	3	17	19	0.1	9
ESDCAN05-2BWY	0.1	36	39	43.3	1	-45	45	61	3	3	3.5	0.01	9
ESDCAN06-2BWY	0.1	35	38	42.2	1	-44	44	59	3	13	15	0.1	9

1. ΔC : capacitance variation between IO1 and IO2 versus GND

2. to calculate V_{BR} versus T_j ; V_{BR} at $T_j = V_{BR}$ at $25\text{ }^{\circ}\text{C} \times (1 + \alpha T \times (T_j - 25))$

1.1 Characteristics (curves)

Figure 2. Maximum peak current versus initial junction temperature

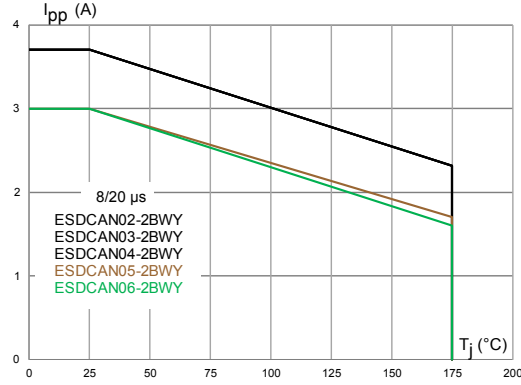

Figure 3. Maximum peak pulse current versus exponential pulse duration

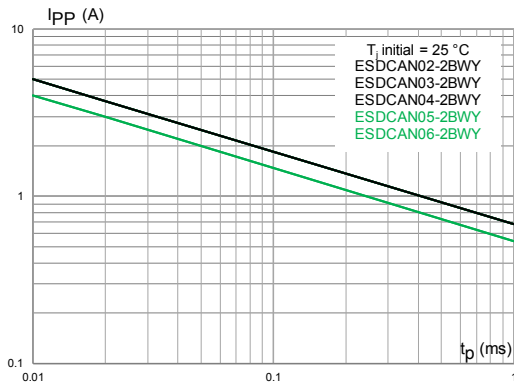

Figure 4. Peak pulse current versus clamping voltage

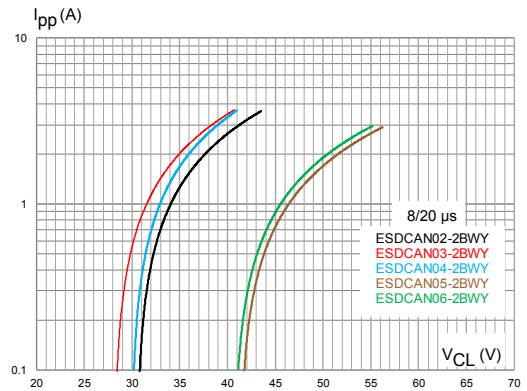

Figure 5. Junction capacitance versus reverse applied voltage

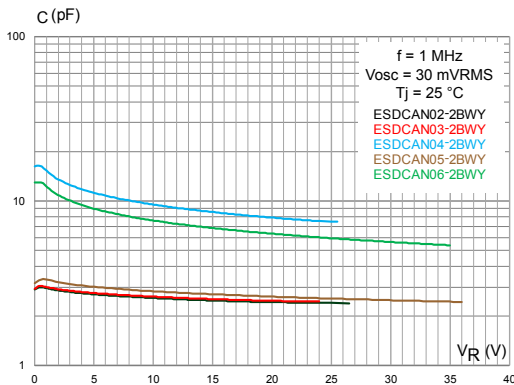

Figure 6. Leakage current versus junction temperature

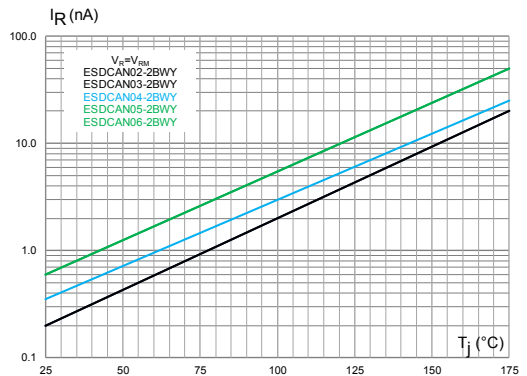

Figure 7. Response to ISO 10605 -C = 150 pF, R = 330 Ω (-8 kV contact)

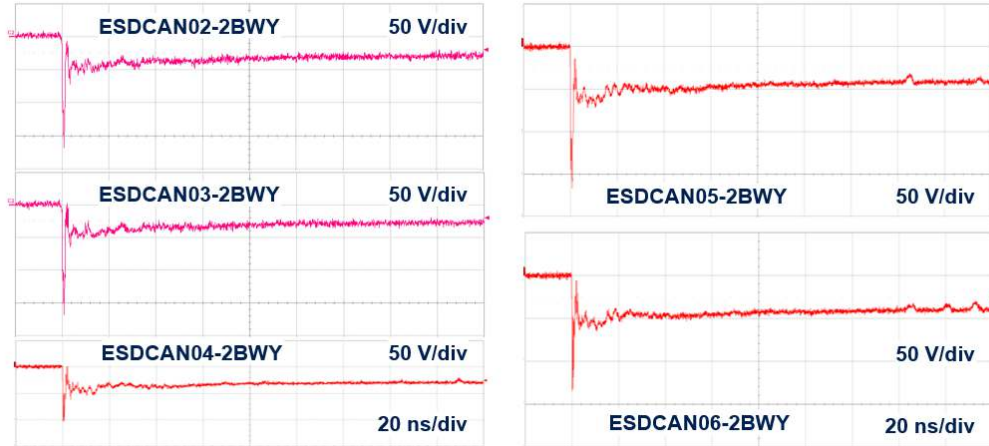

Figure 8. Response to ISO 10605 - C = 150 pF, R = 330 Ω (+8 kV contact)

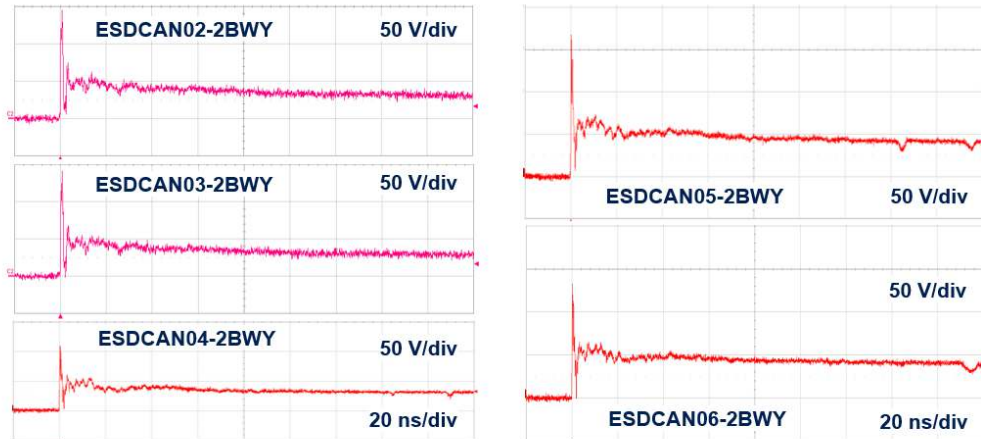

Figure 9. Response to ISO 7637-3 Pulse 3a: -150 V

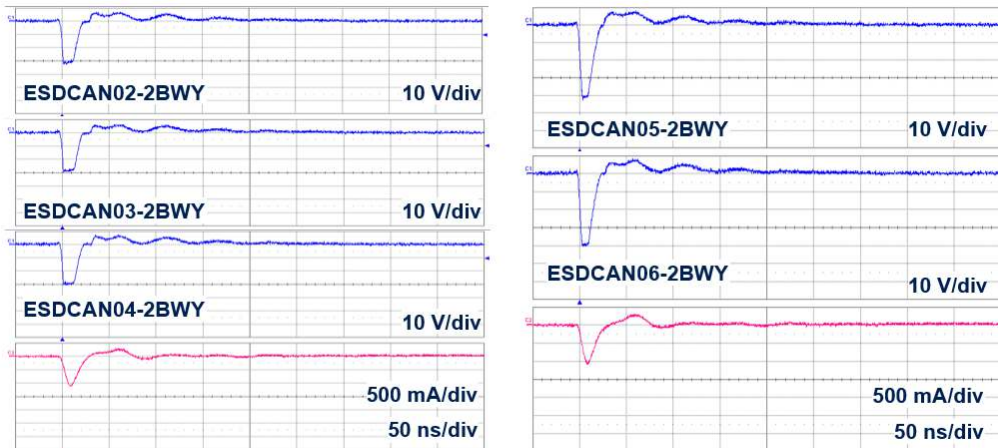

Figure 10. Response to ISO 7637-3 Pulse 3b : +150 V

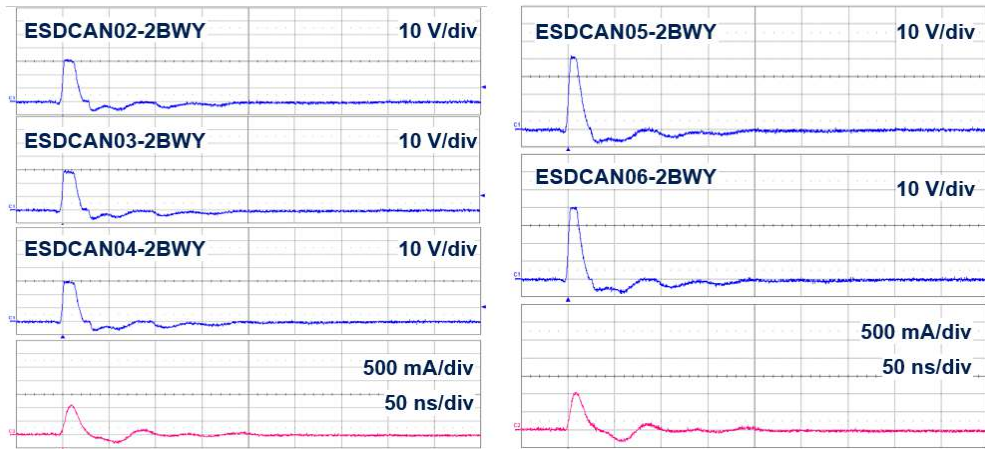

Figure 11. Response to ISO 7637-3 pulse 2a: -85 V

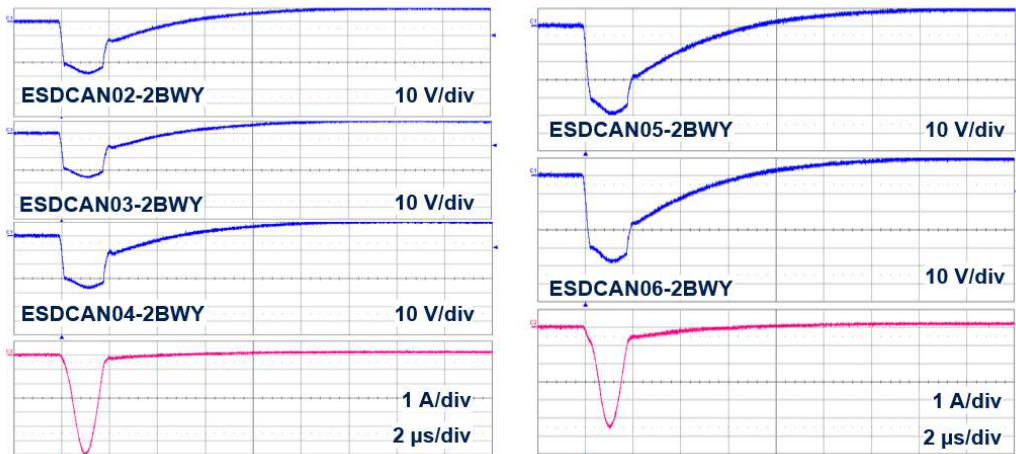

Figure 12. Response to ISO 7637-3 pulse 2a: +85 V

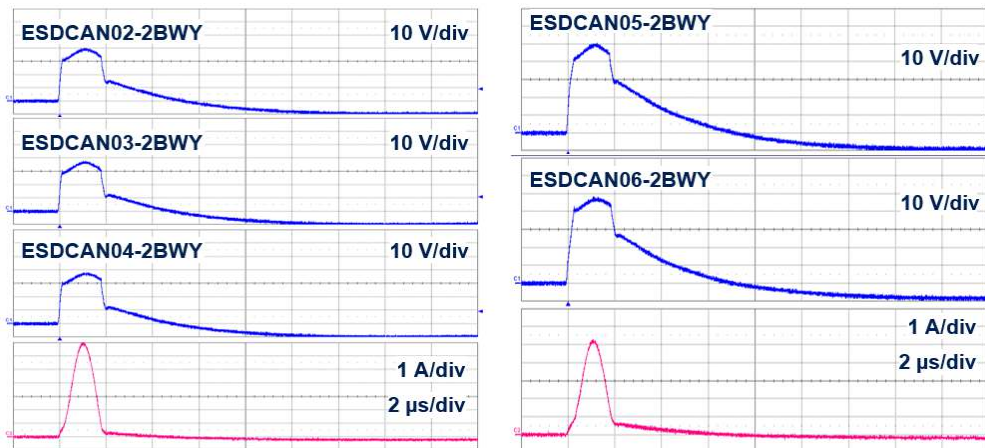

Figure 13. S21 attenuation

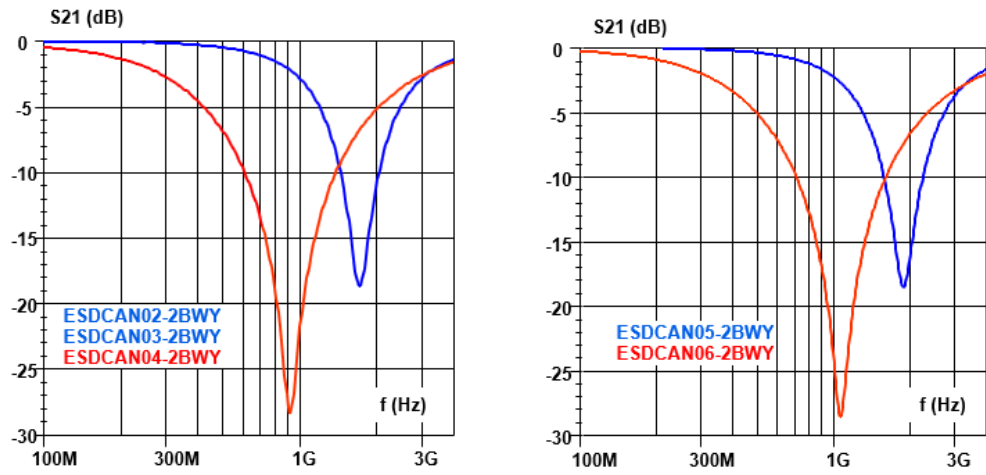
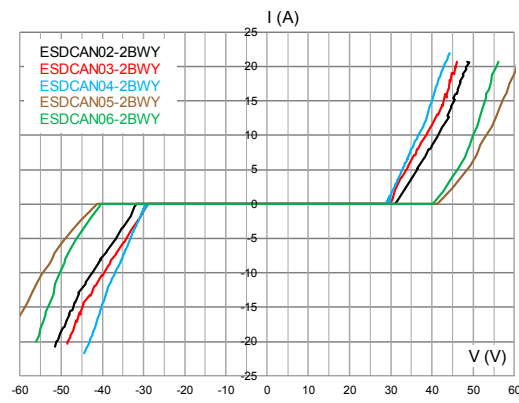

Figure 14. TLP



2 Package information

In order to meet environmental requirements, ST offers these devices in different grades of **ECOPACK** packages, depending on their level of environmental compliance. ECOPACK specifications, grade definitions and product status are available at: www.st.com. ECOPACK is an ST trademark.

2.1 SOT323-3L package information

Figure 15. SOT323-3L package outline

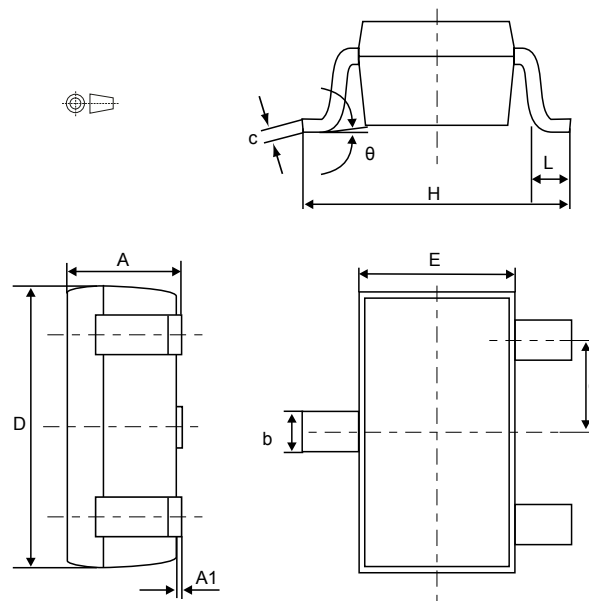

Table 3. SOT323-3L package mechanical data

Ref.	Dimensions					
	Millimeters			Inches ⁽¹⁾		
	Min.	Typ.	Max.	Min.	Typ.	Max.
A	0.80		1.10	0.031		0.044
A1	0.00		0.10	0.000		0.004
b	0.25		0.40	0.009		0.016
c	0.10		0.26	0.003		0.011
D	1.80	2.00	2.20	0.070	0.079	0.087
E	1.15	1.25	1.35	0.045	0.049	0.054
e	0.60	0.65	0.70	0.023	0.026	0.028
H	1.80	2.10	2.40	0.070	0.083	0.095
L	0.10	0.20	0.30	0.004	0.008	0.012
θ		0	30°		0	30°

1. Values in inches are converted from mm and rounded to 3 decimal digits

2.2 Packing information

Figure 16. SOT323-3L footprint in mm

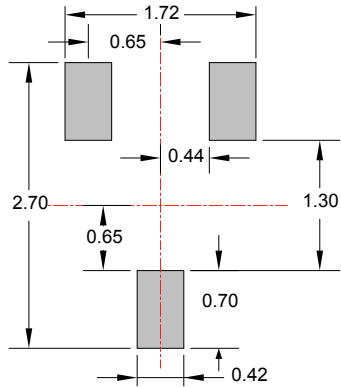

Figure 17. SOT323-3L marking

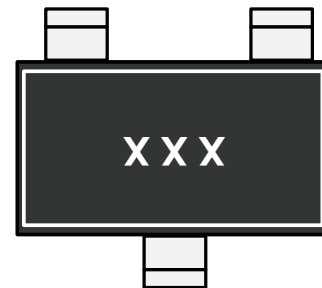
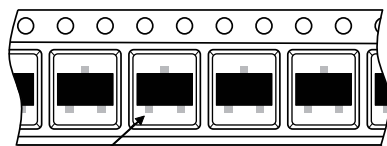

Figure 18. Package orientation in reel



Pin 1 located according to EIA-481

Note: Pocket dimensions are not on scale
Pocket shape may vary depending on package

Figure 19. Tape and reel orientation

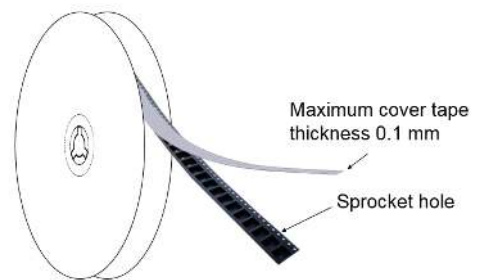

Figure 20. 7" reel dimension values

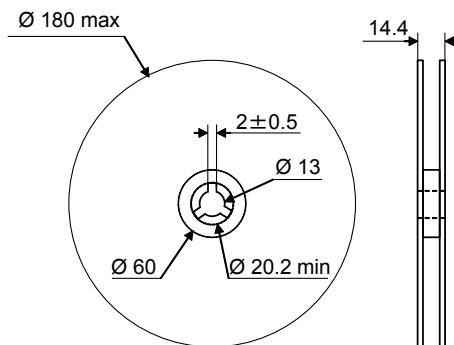

Figure 21. Inner box dimension values

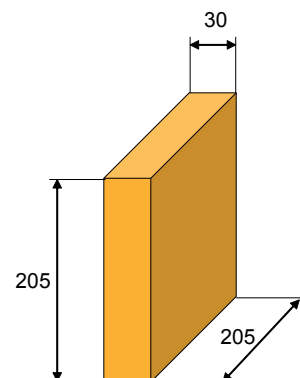
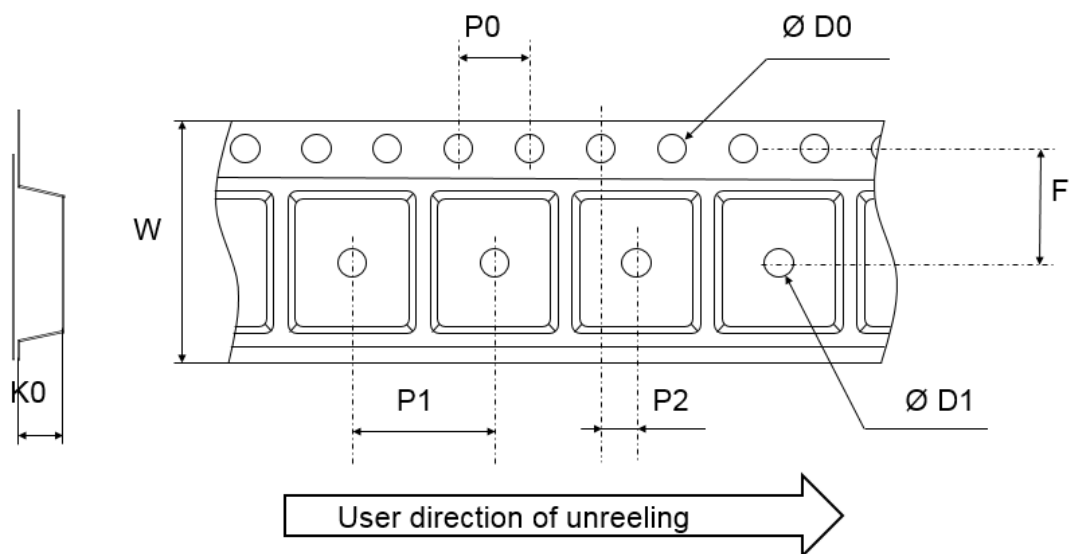

Figure 22. Tape outline



Note: Pocket dimensions are not on scale
Pocket shape may vary depending on package

Table 4. Tape dimension values

Ref.	Dimensions		
	Millimeters		
	Min.	Typ.	Max.
D0	1.50	1.55	1.6
D1	1.00		
F	3.45	3.50	3.55
K0	1.12	1.22	1.32
P0	3.90	4.00	4.10
P1	3.90	4.00	4.10
P2	1.95	2.00	2.05
W	7.90	8.00	8.30

3 Reflow profile

Figure 23. ST ECOPACK® recommended soldering reflow profile for PCB mounting

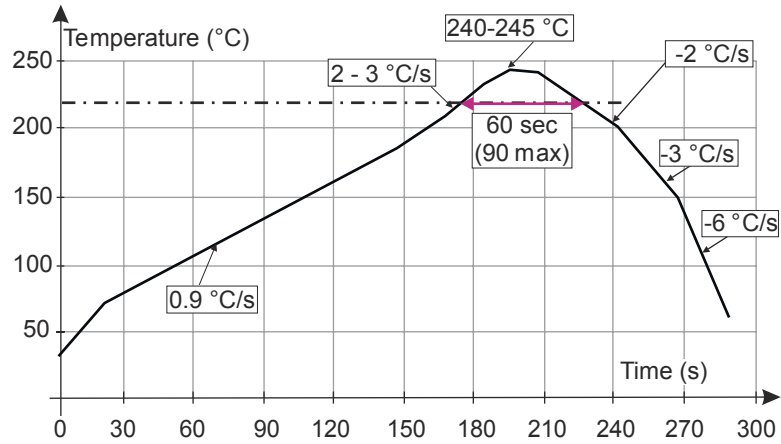

Note: Minimize air convection currents in the reflow oven to avoid component movement. Maximum soldering profile corresponds to the latest IPC/JEDEC J-STD-020.

4 Ordering information

Figure 24. Ordering information scheme

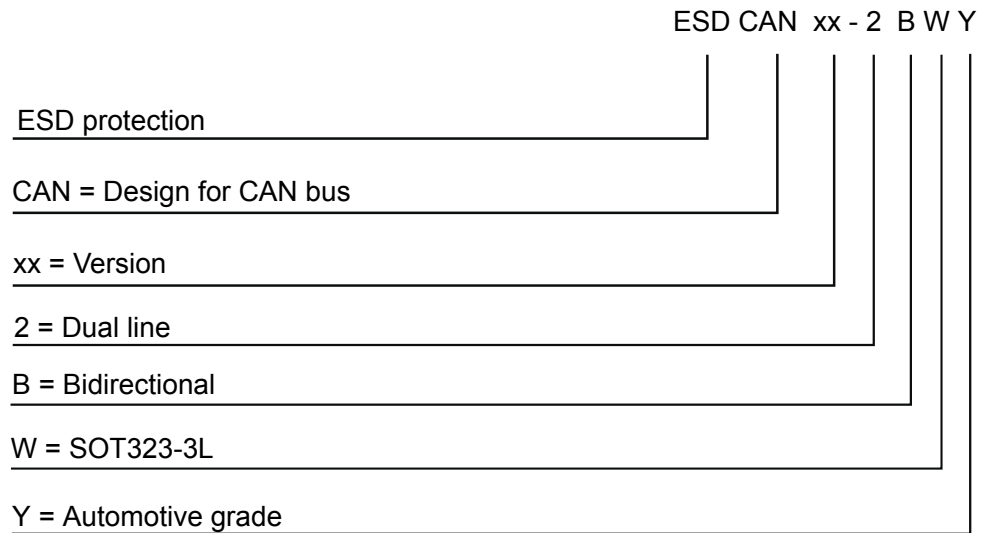

Table 5. Ordering information

Order code	Marking ⁽¹⁾	Package	Weight	Base qty.	Delivery mode
ESDCAN02-2BWY	C02	SOT323-3L	6.58 mg	3000	Tape and reel
ESDCAN03-2BWY	C03				
ESDCAN04-2BWY	C04				
ESDCAN05-2BWY	C05				
ESDCAN06-2BWY	C06				

1. The marking can be rotated by multiples of 90° to differentiate assembly location

Revision history

Table 6. Document revision history

Date	Revision	Changes
17-Oct-2018	1	First issue.
13-Nov-2018	2	Updated product name on cover page.
19-Jul-2022	3	Updated Description , Features and Table 1 .

IMPORTANT NOTICE – READ CAREFULLY

STMicroelectronics NV and its subsidiaries (“ST”) reserve the right to make changes, corrections, enhancements, modifications, and improvements to ST products and/or to this document at any time without notice. Purchasers should obtain the latest relevant information on ST products before placing orders. ST products are sold pursuant to ST’s terms and conditions of sale in place at the time of order acknowledgment.

Purchasers are solely responsible for the choice, selection, and use of ST products and ST assumes no liability for application assistance or the design of purchasers’ products.

No license, express or implied, to any intellectual property right is granted by ST herein.

Resale of ST products with provisions different from the information set forth herein shall void any warranty granted by ST for such product.

ST and the ST logo are trademarks of ST. For additional information about ST trademarks, refer to www.st.com/trademarks. All other product or service names are the property of their respective owners.

Information in this document supersedes and replaces information previously supplied in any prior versions of this document.

© 2022 STMicroelectronics – All rights reserved