

## DESCRIPTION

The EV4460DQ-01B is an evaluation board for the MP4460, a high frequency step-down regulator with an integrated power MOSFET.

The wide input range of MP4460 accommodates a variety of step-down applications, including those in an automotive input environment. A 100µA operational quiescent current allows use in battery-powered applications.

The frequency foldback helps prevent inductor current runaway during startup and thermal shutdown provides reliable, fault tolerant operation.

By switching at 4MHz, the MP4460 is able to prevent EMI (Electromagnetic Interference) noise problems, such as those found in AM radio and ADSL applications.

## ELECTRICAL SPECIFICATIONS

Parameter	Symbol	Value	Units
Input Voltage	$V_{IN}$	7.5 – 36	V
Output Voltage	$V_{OUT}$	3.3	V
Output Current	$I_{OUT}$	2.5	A

## FEATURES

- 2.5 A Output Current
- Wide 7.5V to 36V Operating Range
- Output at 3.3V
- Up to 95% Efficiency
- Up to 4MHz Programmable Switching Frequency
- Ceramic Capacitor Stable
- Internal Soft-Start

## APPLICATIONS

- High Voltage Power Conversion
- Automotive Systems
- Industrial Power Systems
- Distributed Power Systems
- Battery Powered Systems

"MPS" and "The Future of Analog IC Technology" are Registered Trademarks of Monolithic Power Systems, Inc.

## EV4460DQ-01B EVALUATION BOARD



(L x W x H) 1.8" x 1.8" x 0.4"  
(4.6cm x 4.6cm x 1.0cm)

Board Number	MPS IC Number
EV4460DQ-01B	MP4460DQ

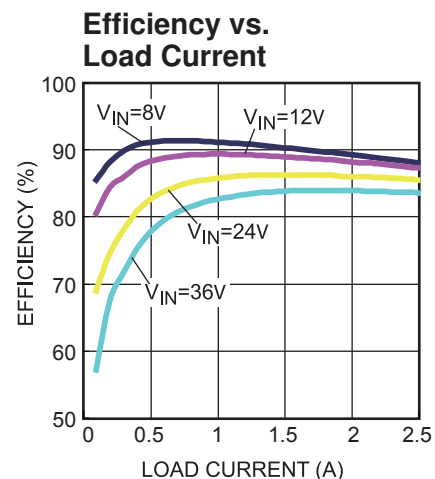

## EVALUATION BOARD SCHEMATIC

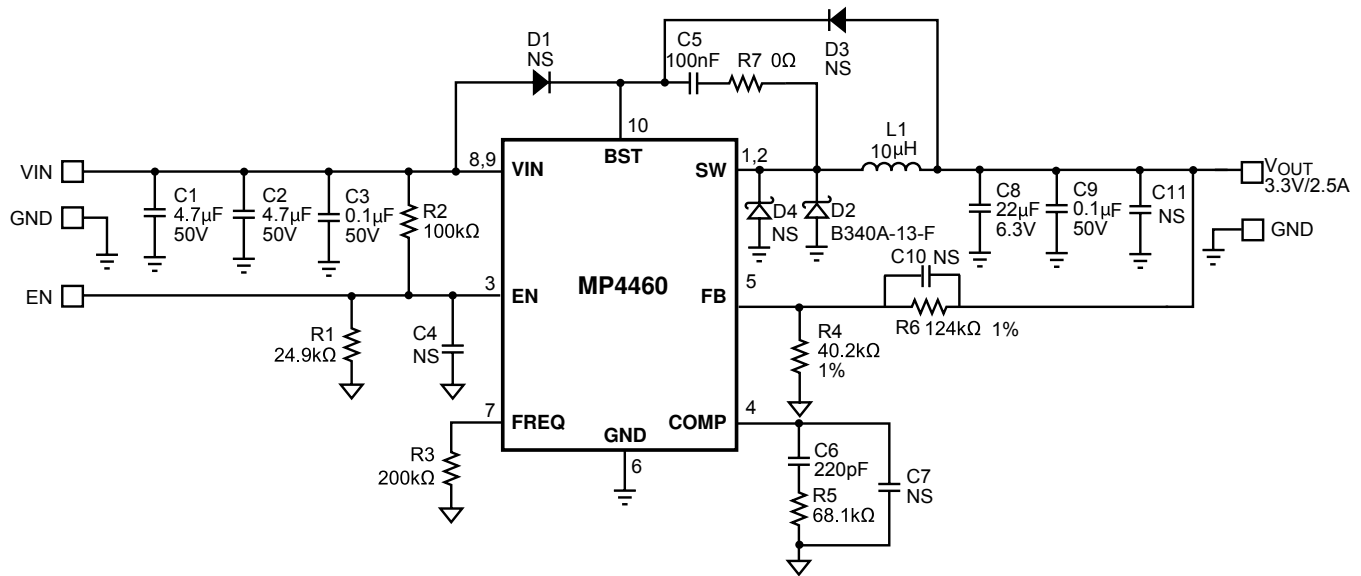

## EV4460DQ-01B BILL OF MATERIALS

Qty	Ref	Value	Description	Package	Manufacturer	Manufacturer P/N
2	C1, C2	4.7 $\mu$ F	Ceramic Cap. 50V, X7R	SMC1210	muRata	GRM32ER71H475K
1	C3	0.1 $\mu$ F	Ceramic Cap. 50V, X7R	SMC0603	muRata	GRM188R71H104K
4	C4, C7, C10, C11		Do Not Stuff			
2	C5, C9	0.1 $\mu$ F	Ceramic Cap. 16V, X7R	SMC0603	muRata	GRM188R71C104K
1	C6	220pF	Ceramic Cap. 50V, COG	SMC0603	muRata	GRM188COG1H221K
1	C8	22 $\mu$ F	Ceramic Cap. 6.3V, X5R	SMC1210	muRata	GRM32ER60J226K
3	D1, D3, D4		Do Not Stuff			
1	D2		Diode Schottky, 40V, 3A	SMA	Diodes Inc	B340A-13-F
1	R1	24.9k	Film Resistor, 1%	SMR0603	Panasonic	ERJ-3EKF2492V
1	R2	100k	Film Resistor, 5%	SMR0603	Panasonic	ERJ-3GEYJ104V
1	R3	200k	Film Resistor, 5%	SMR0603	Panasonic	ERJ-3GEYJ204V
1	R4	40.2k	Film Resistor, 1%	SMR0603	Panasonic	ERJ-3EKF4022V
1	R5	68.1k	Film Resistor, 1%	SMR0603	Panasonic	ERJ-3EKF6812V
1	R6	124k	Film Resistor, 1%	SMR0603	Panasonic	ERJ-3EKF1243V
1	R7	0	Film Resistor, 5%	SMR0603	Panasonic	ERJ-3GEY0R00V
1	L1	10 $\mu$ H	Inductor, 4A	SMD	Sumida	CDRH8D43-100
					Cooper	SD8350-100-R
1	U1		Step-Down Regulator	QFN10	Monolithic Power Systems Inc.	MP4460DQ

**PRINTED CIRCUIT BOARD LAYOUT**

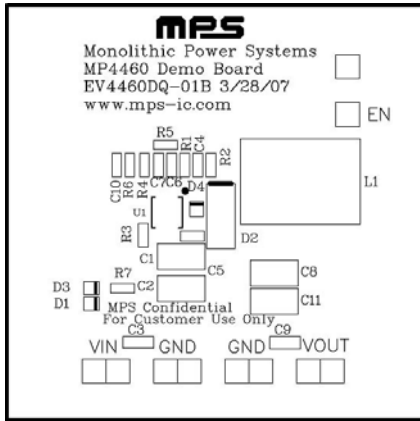

**Figure 1—Top Silk Layer**

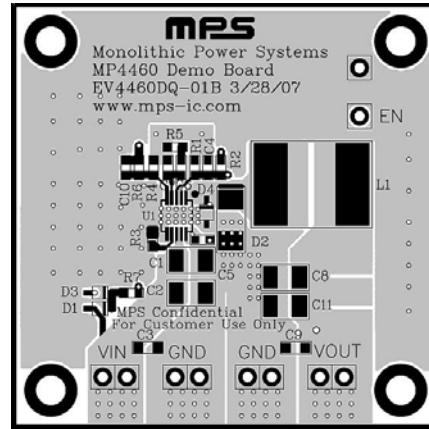

**Figure 2—Top Layer**

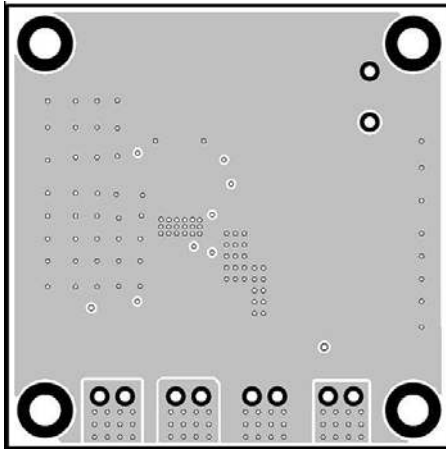

**Figure 3—Inner Layer 1**

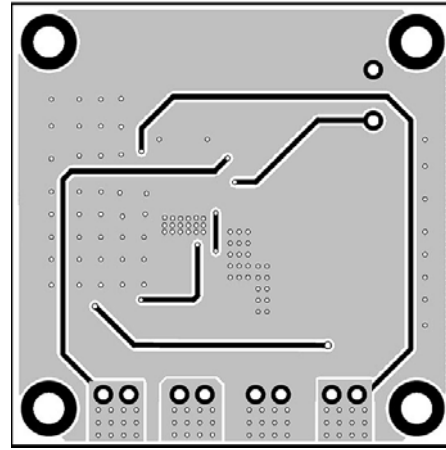

**Figure 4—Inner Layer 2**

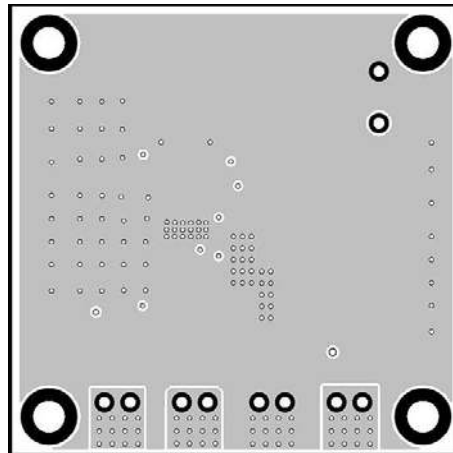

**Figure 5—Bottom Layer**

## QUICK START GUIDE

1. Connect the positive terminal of the load to VOUT pins, and the negative terminal of the load to GND pins.
2. Preset the power supply output to 12V and turn off the power supply.
3. Connect the positive terminal of the power supply output to the VIN pin and the negative terminal of the power supply output to the GND pin.
4. Turn the power supply on. The EV4460 will automatically start up.
5. To use the Enable function, apply a digital input to EN pin. Drive EN higher than 1.5V to turn on the regulator, drive EN less than 1.2V to turn it off.
6. An input under voltage lockout (UVLO) function is implemented by the addition of a resistor divider R1 and R2. The EN threshold is 1.5V (rising edge), so VIN UVLO threshold is  $1.5V \times (1+R2/R1)$ . It's preset to 7.5V on this board.
7. Use R3 to re-program switching frequency if needed,  $f_s(\text{kHz}) = \frac{60000}{R3(\text{k}\Omega)^{0.91}}$ . The switching frequency is preset to 500kHz on this board. Please note that an external bootstrap diode from 5V supply to BST pin is necessary to boost gate drive voltage if switching frequency is above 2MHz because the charge time is reduced at high switching frequency.
8. Use R4, R6 to set output voltage,  $V_{FB}=0.8V$ . For  $R2=40.2\text{k}\Omega$ , R1 can be determined by:  $R1 = 50.25 \times (V_{OUT} (V) - 0.8) (\text{k}\Omega)$ . Please follow the application information on the datasheet to recalculate/or select compensation values, inductor value, and output capacitor value when the  $V_{OUT}$  is changed.

**NOTICE:** The information in this document is subject to change without notice. Users should warrant and guarantee that third party Intellectual Property rights are not infringed upon when integrating MPS products into any application. MPS will not assume any legal responsibility for any said applications.