







RF TRANSFORMERS

Transformers for Wideband RF Applications



-  Ultra-compact surface mount package
-  Increased reliability due to “uni-core” construction
-  Very short leads for maximized RF performance
-  Ideal for Balanced-to-Unbalanced applications
-  Products from 5 to 1000MHz bandwidth
-  Patent pending

Electrical Specifications @ 25°C — Operating Temperature 0°C to 70°C

Part Number	Impedance Ratio Pri:Sec (±2%)	Bandwidth (MHz TYP) ≤1dB	Insertion Loss (dB TYP) Midband	Schematic	Primary Pins
C2139NL	1:1	5 to 1000	0.4	C	4-6

NOTE: Optional Tape & Reel packaging can be ordered by adding a “T” suffix to the part number (ex: C2139NLT). — NL: Lead-Free

Mechanical

Schematic

BAUER

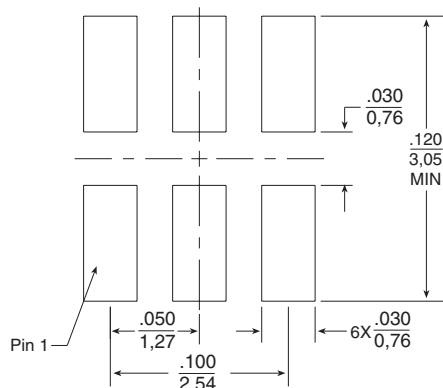
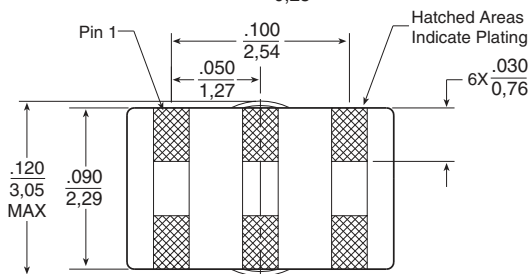
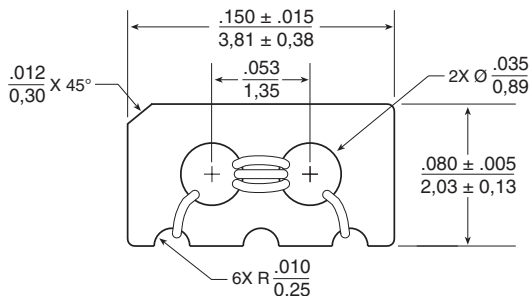

SUGGESTED PAD LAYOUT

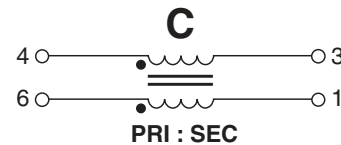

Tape & Reel3000/reel
 Tray100 /tray
 Power Rating30 mA MAX; 0.25 W MAX

Dimensions: $\frac{\text{Inches}}{\text{mm}}$
 Unless otherwise specified, all tolerances are $\pm \frac{.010}{0,25}$

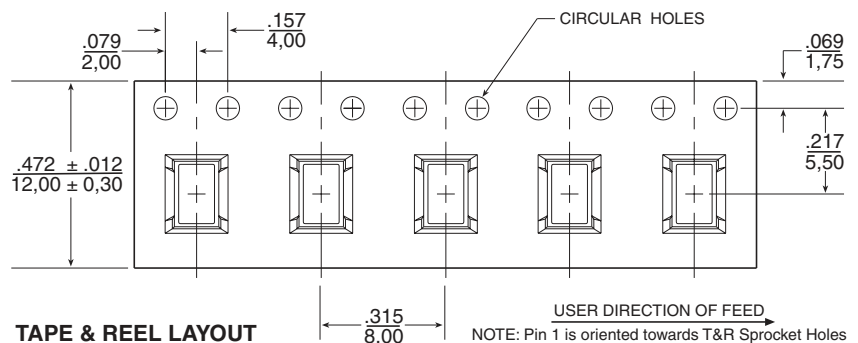

TAPE & REEL LAYOUT

NOTE: Pin 1 is oriented towards T&R Sprocket Holes

Application Notes

For additional impedance ratios and frequency ranges, please contact Pulse Applications Engineering.

Typical Insertion Loss @ 25°C

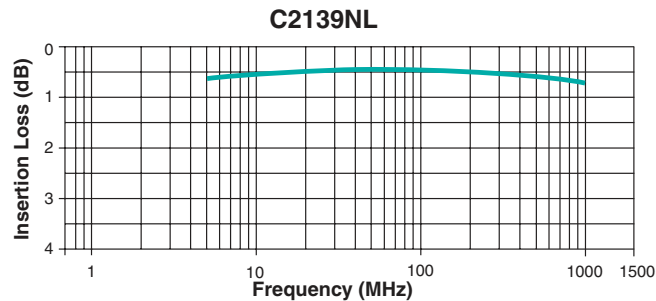

Bauer Series* Compatibility with Racket-Lite Series*

For customers who are looking for a broader selection and interchangeability between series of RF transformers, selective parts in Racket-Lite series have similar performances as in Bauer Series. Racket-Lite and Bauer series also have identical pin to pin spacing so that using the below pad layout will accommodate both product series in the same footprint.

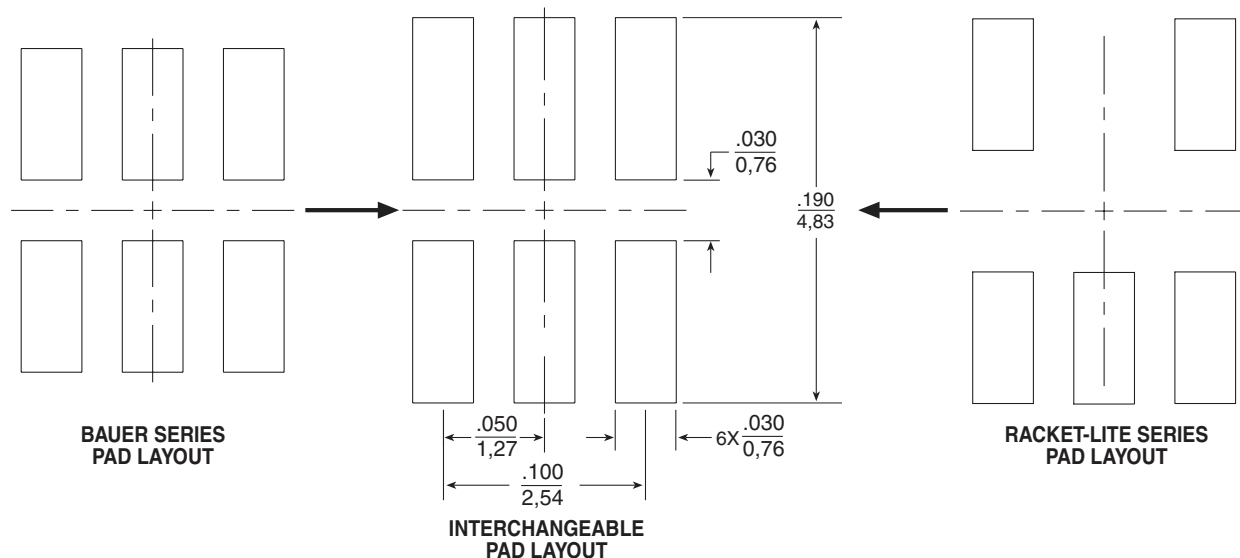

***NOTE:** Bauer and Racket-Lite are package family names. They are used to distinguish different Pulse Transformer and Balun packages. These and other packages can be found on the Pulse web site under RF Transformers/Baluns, using the Product Finder.

For More Information :

UNITED STATES (Worldwide)	UNITED KINGDOM (Northern Europe)	FRANCE (Southern Europe)	SINGAPORE (Southern Asia)	TAIWAN, R.O.C. (Northern Asia)	HONG KONG (China/Hong Kong)	DISTRIBUTOR
12220 World Trade Drive San Diego, CA 92128 U.S.A. http://www.pulseeng.com TEL: 858 674 8100 FAX: 858 674 8262	3 Huxley Road Surrey Research Park Guildford, Surrey GU2 5RE United Kingdom TEL: 44 1483 401700 FAX: 44 1483 401701	Zone Industrielle F-39270 Orgelet France TEL: 33 3 84 35 04 04 FAX: 33 3 84 25 46 41	150 Kampong Ampat #07-01/02 KA Centre Singapore 368324 TEL: 65 6287 8998 FAX: 65 6280 0080	3F-4, No. 81, Sec. 1 HsinTai Wu Road Hsi-Chih, Taipei Hsien Taiwan, R.O.C. Tel: 886 2 2698 0228 FAX: 886 2 2698 0948	9/F, Phase 2, Tai Sang Shatin Warehouse Centre 6 Wong Chuk Yeung Street Fotan, Shatin, Hong Kong TEL: 852 2788 6588 FAX: 852 2776 1055	

Performance warranty of products offered on this data sheet is limited to the parameters specified. Data is subject to change without notice. Other brand and product names mentioned herein may be products and/or registered trademarks of their respective owners.